

1U Stackable Distribution Shelf – 19 in Rack Mount

J2013001 - multiple models - See SPS, CP, or NE Brochure for models.

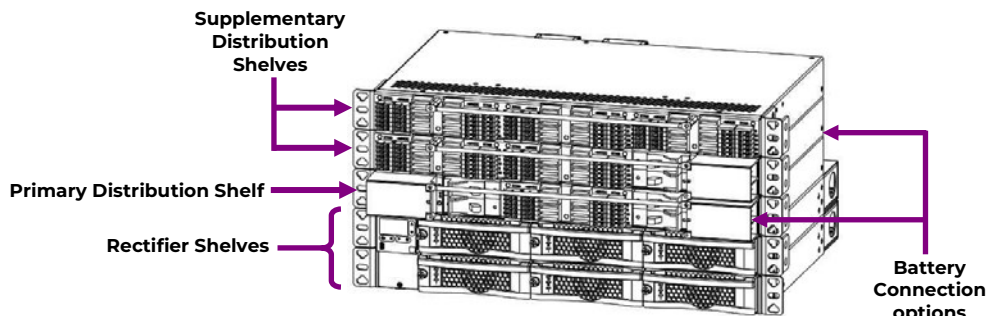
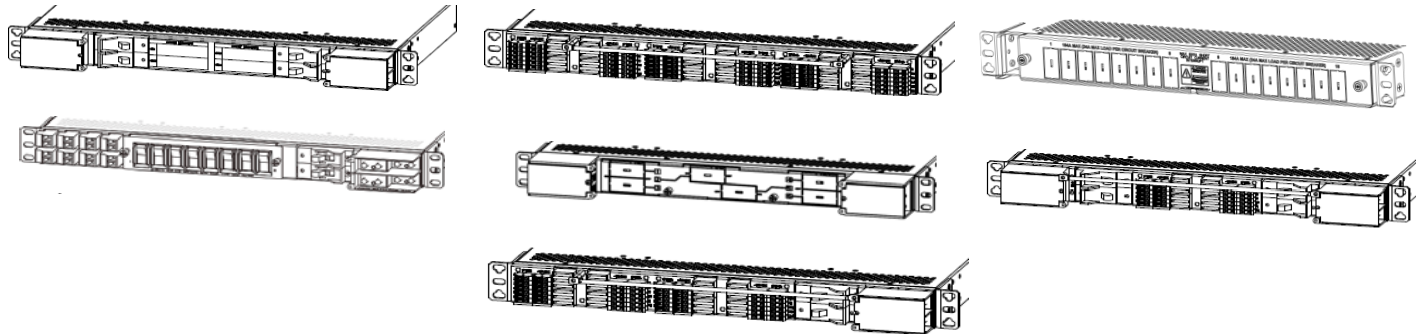

SPS System Example

Distribution shelves may be used together as shown above in SPS, CP, and NE systems or used as stand-alone remote distribution (cabled to a power system).

Some Primary distribution shelves have battery connections. Some models also include battery contactors.

Install the primary distribution shelf immediately above the primary SPS, CP or NE rectifier shelf. Communication cables and interconnecting hardware are included.

Controller is installed either in distribution shelf or in supply shelf according to configuration.

Refer to SPS, CP or NE-S Power System Brochure for details and accessories.

Document: 850033855

Safety Statements

- Do not install this equipment over combustible surfaces.
- Rules and Regulations – Follow all national and local rules and regulations when making field connections.
- Compression Connectors
 - U. S. or Canada installations – use Listed/Certified compression connectors to terminate Listed/Certified field – wire conductors.
 - All installations – apply the appropriate connector to the correct size conductor as specified by the connector manufacturer, using only the connector manufacturer’s recommended or approved tooling for that connector.
- Electrical Connection Securing: Torque to the values specified on labels or in the product documentation.
- Cable Dress – dress to avoid damage to the conductors and undue stress on the connectors.
- Circuit Breakers and Fuses
 - Use only those specified in the equipment ordering guide.
 - Size as required by the National Electric Code (NEC) and/or local codes.
 Safety Tested Limits – Refer to the equipment ratings to assure current does not exceed:
 Continuous Load (List 1) – 80% of protector rating
- Field – wired Conductors – Follow all National Electric Code (NEC) and local rules and regulations.
 - Insulation rating: 90°C minimum; 105°C (minimum) if internal to enclosed equipment cabinets.
 - Size AC field-wired conductors with 75°C ampacity (NEC) equal to or greater than their panel board circuit breaker rating.
- AC and DC input disconnect/protection – Provide accessible devices to remove input power in an emergency.
- Grounding – Connect the equipment chassis directly to ground. In enclosed equipment cabinets connect to the cabinet AC service ground bus. In huts, vaults, and central offices connect to the system bonding network.
- Do not place combustible materials directly above or below equipment.
- This equipment is not suitable for use in locations where children are likely to be present.
- Installation in restricted access areas only.

Note: Proper grounding of AC supply receptacles must be verified by qualified personnel.

Énoncés de sécurité

- N'installez pas cet équipement sur des surfaces combustibles.
- Règles et règlements – Suivez toutes les règles et réglementations nationales et locales lorsque vous établissez des connexions sur le terrain.
- Connecteurs de compression
 - Installations aux États-Unis ou au Canada – utilisez des connecteurs de compression répertoriés/certifiés pour terminer les conducteurs de fil de champ répertoriés/certifiés.
 - Toutes les installations – appliquez le connecteur approprié au conducteur de taille correcte spécifié par le fabricant du connecteur, en utilisant uniquement l'outillage recommandé ou approuvé par le fabricant du connecteur pour ce connecteur.
- Sécurisation de la connexion électrique : Couple aux valeurs spécifiées sur les étiquettes ou dans la documentation du produit.
- Robe de câble – habillez-vous pour éviter d'endommager les conducteurs et de solliciter inutilement les connecteurs.
- Disjoncteurs et fusibles
 - Utilisez uniquement ceux spécifiés dans le guide de commande d'équipement.
 - Taille requise par le Code national de l'électricité (NEC) et/ou les codes locaux.
 - Limites des tests de sécurité – Reportez-vous aux cotes de l'équipement pour vous assurer que le courant ne dépasse pas :
Charge continue (liste 1) – 80 % de l'indice de protection
- Conducteurs câblés sur le terrain – Respectez toutes les règles et réglementations nationales du Code national de l'électricité (NEC) et locales.
 - Indice d'isolation : 90°C minimum ; 105 °C (minimum) si interne aux armoires d'équipement fermées.
 - Taille des conducteurs câblés sur le terrain AC avec une ampacité de 75°C (NEC) égale ou supérieure à leur circuit nominal de carte de panneau.
- Débranchement/protection des entrées CA et CC – Fournissez des dispositifs accessibles pour couper l'alimentation d'entrée en cas d'urgence.
- Mise à la terre – Connectez le châssis de l'équipement directement à la terre. Dans les armoires d'équipement fermées, connectez-vous au bus de masse de service CA de l'armoire. Dans les huttes, les chambres fortes et les bureaux centraux se connectent au réseau de liaison du système.
- Ne placez pas de matières combustibles directement au-dessus ou au-dessous de l'équipement.
- Cet équipement ne convient pas à une utilisation dans des endroits où des enfants sont susceptibles d'être présents
- Installation dans des zones à accès restreint uniquement

Remarque: La mise à la terre adéquate des prises d'alimentation en courant alternatif doit être vérifiée par du personnel qualifié.

Precautions

- Install, service, and operate equipment only by professional, skilled and qualified personnel who have the necessary knowledge and practical experience with electrical equipment and who understand the hazards that can arise when working on this type of equipment.
- Do not disconnect permanent bonding connections unless all power inputs are disconnected.
- Verify that equipment is properly safety earth grounded before connecting power. High leakage currents may be possible.
- Exercise care and follow all safety warnings and practices when servicing this equipment. Hazardous energy and voltages are present in the unit and on the interface cables that can shock or cause serious injury.
- Use the following precautions in addition to proper job training and safety procedures:
 - Use only properly insulated tools.
 - Remove all metallic objects (key chains, glasses, rings, watches, or other jewelry).
 - Follow Lock Out Tag Out (LOTO) procedures: customer specified, site specific, or general as appropriate. Disconnect all power input before servicing the equipment. Check for multiple power inputs.
 - Wear safety glasses.
 - Follow Personal Protective Equipment requirements: customer specified, site specific, or general as appropriate.
 - Test circuits before touching.
 - Be aware of potential hazards before servicing equipment.
 - Identify exposed hazardous electrical potentials on connectors, wiring, etc.
 - Avoid contacting circuits when removing or replacing covers;.
 - Use a personal ESD strap when accessing or removing electronic components.
- Personnel with electronic medical devices need to be aware that proximity to DC power and distribution systems, including batteries and cables, typically found in telecommunications utility rooms, can affect medical electronic devices, such as pacemakers. Effects decrease with distance.
- Exercise care and follow all safety warnings and practices when servicing this equipment. Hazardous energy and voltages are present in the unit and on the interface cables that can shock or cause serious injury.



This symbol is used to identify the need for safety glasses and may sometimes be accompanied by some type of statement, for example: "Fuses can cause arcing and sparks. Risk of eye injury. Always wear safety glasses."

Wear safety glasses. Fuses can produce sparks. High energy levels on buses and distribution components can produce severe arcing.

Installing fuses or circuit breakers not specified for use in these distribution modules may result in injury to service personnel or equipment damage. Use only replacement parts listed in this manual and on the equipment drawings.

The telecom-type (e.g., 0481 type) fuses can produce sparks during interruption or clearing of a fault on a high energy circuit. Use only fuses provided with safety caps for this type of circuit. Installing telecom-type fuses not equipped with safety caps may result in injury to service personnel.

Précautions

- Installer, entretenir et utiliser l'équipement uniquement par du personnel professionnel, qualifié et qualifié qui possède les connaissances et l'expérience pratique nécessaires avec l'équipement électrique et qui comprend les dangers qui peuvent survenir lors du travail sur ce type d'équipement.
- Ne débranchez pas les connexions de liaison permanentes à moins que toutes les entrées d'alimentation ne soient déconnectées.
- Vérifiez que l'équipement est correctement mis à la terre avant de brancher l'alimentation. Des courants de fuite élevés peuvent être possibles.
- Faites preuve de prudence et suivez tous les avertissements et pratiques de sécurité lors de l'entretien de cet équipement. De l'énergie et des tensions dangereuses sont présentes dans l'appareil et sur les câbles d'interface qui peuvent choquer ou causer des blessures graves.
- Prenez les précautions suivantes en plus de la formation professionnelle appropriée et des procédures de sécurité :
 - N'utilisez que des outils correctement isolés.
 - Enlevez tous les objets métalliques (porte-clés, lunettes, bagues, montres ou autres bijoux).
 - Suivez les procédures LOTO (Lock Out Tag Out) : spécifiées par le client, spécifiques au site ou générales, selon le cas. Débranchez toute l'alimentation avant d'entretenir l'équipement. Vérifiez s'il y a plusieurs entrées d'alimentation.
 - Portez des lunettes de sécurité.
 - Respectez les exigences relatives à l'équipement de protection individuelle : spécifiées par le client, spécifiques au site ou générales, selon le cas.
 - Testez les circuits avant de les toucher.
 - Soyez conscient des dangers potentiels avant d'entretenir l'équipement.
 - Identifier les potentiels électriques dangereux exposés sur les connecteurs, le câblage, etc.
 - Éviter de contacter les circuits lors du retrait ou du remplacement des couvercles;
 - Utilisez une sangle ESD personnelle lorsque vous accédez à des composants électroniques ou que vous les retirez.
- Le personnel qui possède des appareils médicaux électroniques doit savoir que la proximité des systèmes d'alimentation et de distribution en courant continu, y compris les batteries et les câbles, que l'on trouve généralement dans les salles de services de télécommunications, peut avoir une incidence sur les appareils électroniques médicaux, tels que les stimulateurs cardiaques. Les effets diminuent avec la distance.
- Faites preuve de prudence et suivez tous les avertissements et pratiques de sécurité lors de l'entretien de cet équipement. De l'énergie et des tensions dangereuses sont présentes dans l'unité et sur les câbles d'interface et peuvent provoquer des chocs électriques ou des blessures graves.



Ce symbole est utilisé pour identifier la nécessité de porter des lunettes de sécurité et peut parfois être accompagné d'un certain type de déclaration, par exemple : « Les fusibles peuvent provoquer des arcs électriques et des étincelles. Risque de blessure aux yeux. Portez toujours des lunettes de sécurité.

Portez des lunettes de sécurité. Les fusibles peuvent produire des étincelles. Des niveaux d'énergie élevés sur les bus et les composants de distribution peuvent produire de graves arcs électriques.

L'installation de fusibles ou de disjoncteurs non spécifiés pour une utilisation dans ces modules de distribution peut entraîner des blessures au personnel de service ou des dommages matériels. Utilisez uniquement les pièces de rechange répertoriées dans ce manuel et sur les dessins de l'équipement.

Les fusibles de type télécommunication (par exemple, type 0481) peuvent produire des étincelles lors de l'interruption ou de l'élimination d'un défaut sur un circuit à haute énergie. Utilisez uniquement des fusibles munis de capuchons de sécurité pour ce type de circuit. L'installation de fusibles de type télécommunication non équipés de capuchons de sécurité peut entraîner des blessures au personnel de service.

11" Deep for SPS		17" Deep for NE/CP		Distribution Shelf Details					
J2013001 List	Ordering code	J2013001 List	Ordering code	Batt CB Slots	Load CB Slots	GMT Fuse Slots	LVBD	Input/Output Ratings	Interrupt Rating
L101	150032396	L701	150034861	2	2	0		42-58Vdc 120A (Charge) 150A (Discharge)	10kA
L101B	150032397	L701B	150034862	2	2	0	Yes	42-58Vdc 120A (Charge) 150A (Discharge)	10kA
L102	150032343	L702	150034863	2	2	12		42-58Vdc 120A (Charge) 150A (Discharge)	3KA
L102B	150032344	L702B	150034864	2	2	12	Yes	42-58Vdc 120A (Charge) 150A (Discharge)	3KA
L103	150032345	L703		2	0	24		42-58Vdc 120A (Charge) 150A (Discharge)	3KA
L103B	150032346	L703B		2	0	24	Yes	42-58Vdc 120A (Charge) 150A (Discharge)	3KA
L104	150032398	L704		0	2	24		42-58Vdc 200A (Charge) 250A (Discharge)	3KA
L105	150032399	L705	150034865	0	4	12		42-58Vdc 200A (Charge) 250A (Discharge)	3KA
L106	150032400	L706	150034866	0	4	0		42-58Vdc 200A (Charge) 250A (Discharge)	10kA
L107	150032401	L707		0	0	36		42-58Vdc 120A (Charge) 150A (Discharge)	3KA
L108B ⁴	150038445	L708B ⁴	150044877	2	8 ²	0	Yes	42-58Vdc 120A (Charge) 150A (Discharge)	600A
L112	150036963	L712	150036162	0 ¹	4	12		42-58Vdc 120A (Charge) 150A (Discharge)	3KA
L112B	150036964	L712B	150036163	0 ¹	4	12	Yes	42-58Vdc 120A (Charge) 150A (Discharge)	3KA
L115	150042292	L715	150042294	0 ¹	6	0		42-58Vdc 120A (Charge) 150A (Discharge)	10kA
L115B	150042293	L715B	150042295	0 ¹	6	0	Yes	42-58Vdc 120A (Charge) 150A (Discharge)	10kA
L116	150041092	L716	150041093	0	6	0		42-58Vdc 200A (Charge) 250A (Discharge)	10kA
		L720 ⁵ L720-CD ⁵	1600480875A 1600423807A	0	16 ³	0		42-58Vdc 368A (Charge)	600A
		L721 ⁵	1600467193A	0	16 ³	0		42-58Vdc 368A (Charge)	600A
		L722-CD ⁵	1600483434A	0	8 ³			42-58Vdc 184A (Charge)	600A

1: Rear Connect

2: Snapak Breaker

3: Snapak Breaker, Rear Connection

4: L108B & L708B Output ratings are at 50°C ambient. At 65°C ambient, output ratings are 80A Charge, 100A Discharge

5: L720x, L721, L722x Output ratings are at 45°C ambient. Derate 1.1%/°C from 45°C to 55°C and 1.6%/°C from 55°C to 65°C. Max rated current of 275A (L720x, L721) and 137A (L722x) at 65°C.

Tools required:

- Torque wrench (0-65 in-lb or 0-10Nm)
- Screw Drivers (#1 Phillips)
- Cable crimpers
- Sockets - 5/16", 7/16"
- Wire cutters and strippers

Step 1 – Mount Distribution Shelf

1. Reposition mounting ears as required - 4 screws each. Torque to 25 In-lbs. (2.8Nm) - Phillips screwdriver.
2. Position initial (primary) distribution shelf immediately above the top rectifier shelf. Position the supplementary distribution shelf immediately above the other distribution shelves.

Note: The system controller may be located in the top rectifier shelf or in the initial (primary) distribution shelf depending on the configuration.

3. Install Inter-Shelf brackets between adjacent shelves (optional). Torque to 25 in-lbs. (2.8Nm) - Phillips screwdriver.
4. Attach shelf to the frame using a minimum of four screws (two on each side) - 12-24 (provided). Torque to 35 in-lb (4Nm) - 5/16" socket.

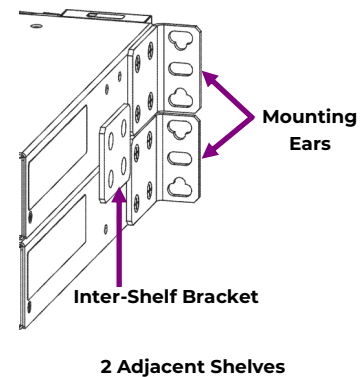

Step 2 – Ground Chassis

Note: Lug landing is M5 on 5/8" centers (lug not provided).
 8 AWG (6mm²) recommended.
 Some applications may rely on frame mounting screws for shelf ground omitting the shelf ground cable.
 Torque to 35 in-lb (4Nm) - 5/16" (8 mm) socket.

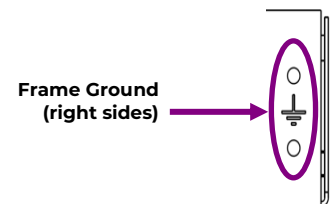

Step 3 – Connect System DC Reference (CO) Ground

Make one connection to the power system (CP, NE, SPS etc).
 No connection to a stand-alone, remote distribution shelf.
 Connections are on the rear under the RETURN cover.

Attach lug adapter to the unused RETURN bus landings of the top or bottom Shelf (850036871 lug adapter is supplied with primary distribution shelves).

Lug landing - 1/4" holes on 5/8" centers (hardware provided, lug not provided).

Torque all hardware to 65 in-lb (7.3 Nm) - 7/16" socket.

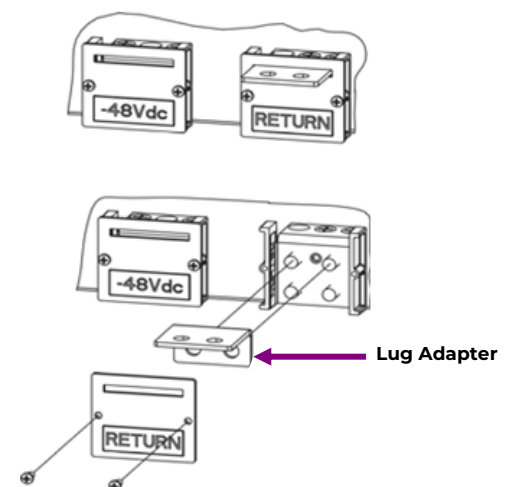

Step 4 – Connect Shelf DC

Connections are on the rear under covers.

Bus Connection - to an adjacent shelf

Install inter-shelf buses joining or +48V and RETURN (depending on configuration) bus connections of adjacent shelves. Torque to 65 in-lb (7.3 Nm).

Cable Connection - Stand-alone Shelf

CAUTION: Verify bus voltage and polarity with a voltmeter before proceeding.

Lug Landings - 2 x 1/4" on 5/8" center, 0.7" (18mm) max. tongue width.

Connect cables with suitable lugs or +48V and RETURN (depending on configuration).

Torque to 65 in-lb (7.3 Nm).

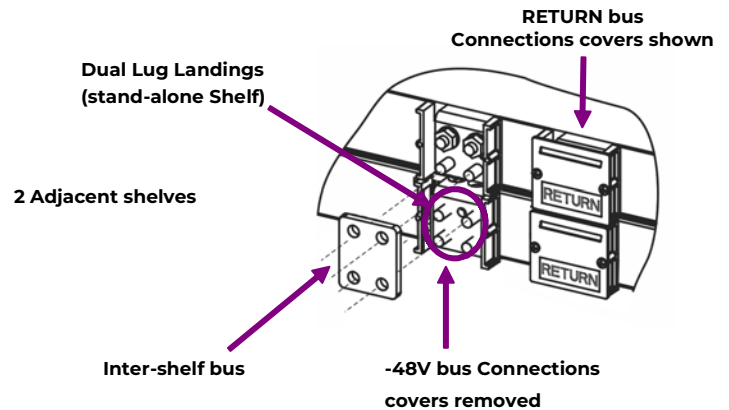

Step 5 – Connect Communication Wires

Connectors are on the rear of the shelf.

1. Connect alarm cable between initial (primary) distribution and adjacent primary or top rectifier shelf if present (wireset provided).

Note: The controller may be in the initial (primary) distribution panel or in the top (primary) rectifier shelf depending on configuration.

2. Connect alarm cables between all Distribution Shelves.

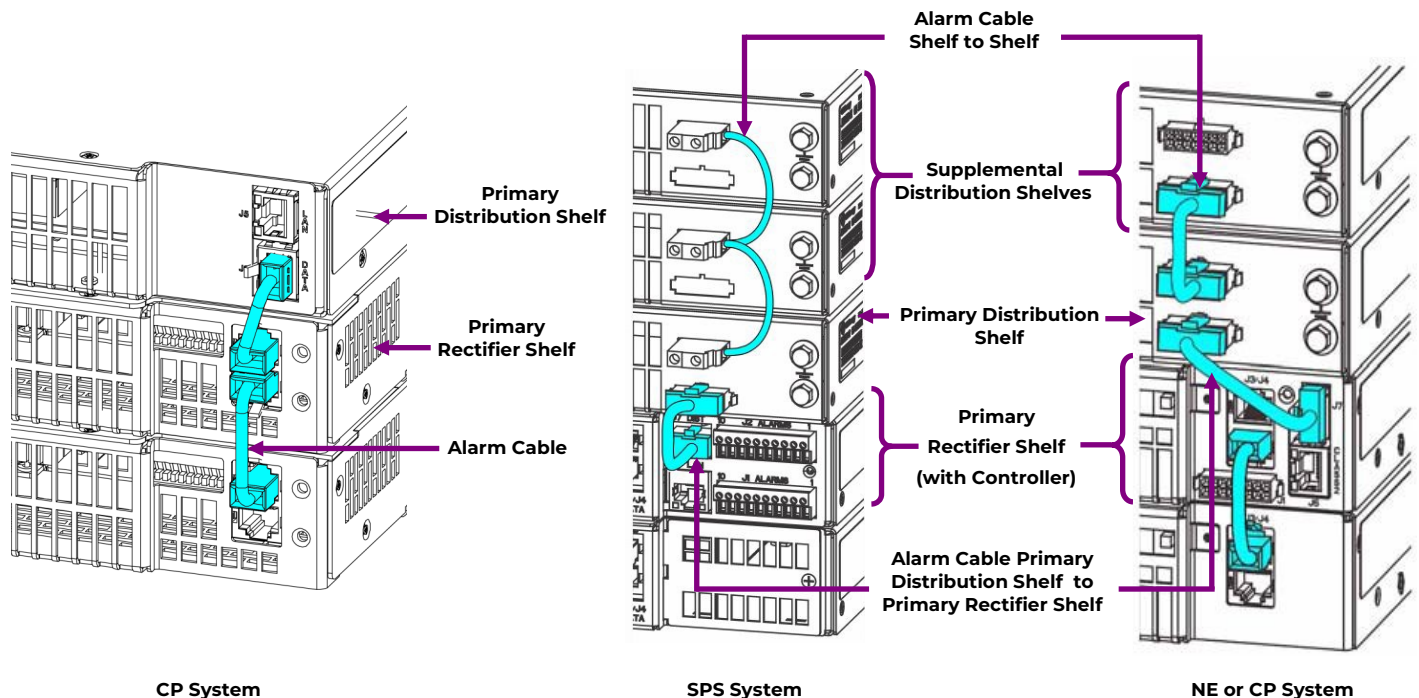

Step 6 – Connect Batteries - skip if not present

Battery connections are labeled “-48Vdc BATT” and “POS RTN”.

Battery connections are either on the rear or front.

Only front battery connections have breakers.

Note: Maximum battery short circuit current of supply batteries must be identified in the final installation to verify that the equipment branch circuit protection interrupt rating is not exceeded.

CAUTION:

- Verify battery voltage and polarity with a voltmeter before proceeding.
- Front Connections only:

Verify that breaker is OFF or not installed.

1. Remove Cover.
2. Connect cables with suitable lugs to -48Vdc BATT and POS RTN landings.
3. Torque to 65 in-lb (7.3 Nm) - 7/16” socket.
4. Replace cover.

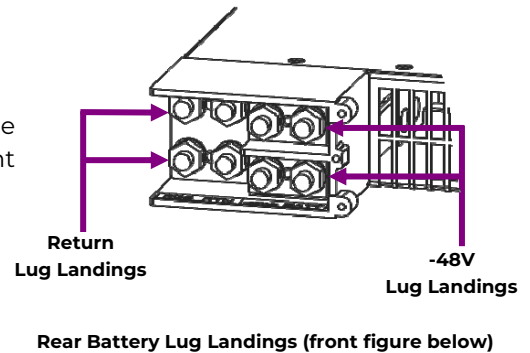

Step 7 – Connect Bullet Circuit Breaker Loads - skip if not present

Load connections are labeled “-48Vdc LOAD” and “POS RTN”. Load Breakers have Black handles.

CAUTION: Verify that breaker is OFF or not installed

1. Remove Cover.
2. Connect wires with suitable lugs to -48Vdc LOAD and POS RTN landings.
3. Torque per table.
4. Replace Cover.

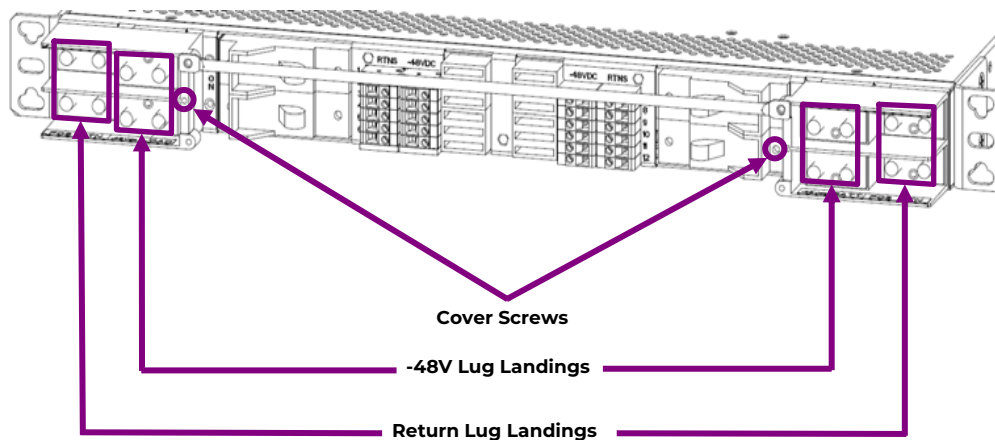

2-Circuit Blocks - Battery or Load

Step 7 – Connect Bullet Circuit Breaker Loads - skip if not present (continued)

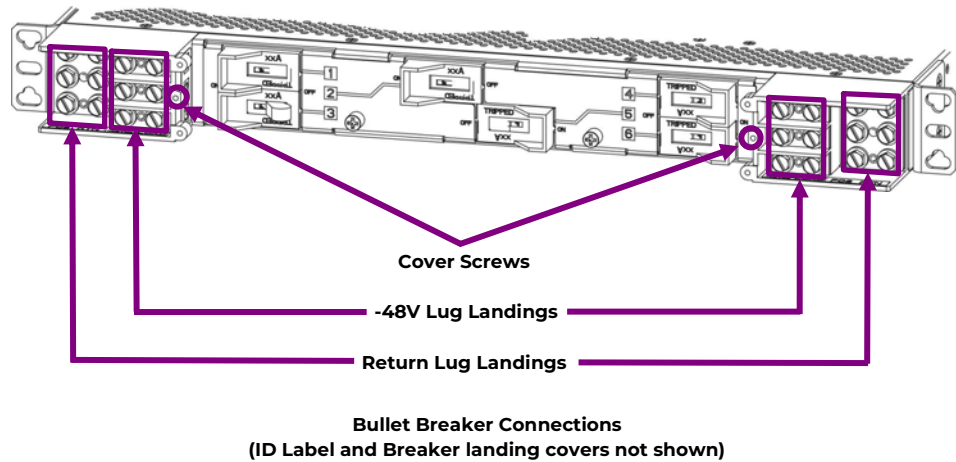

Step 8 – Connect Snapak Circuit Breaker Loads - skip if not present

1. Verify that breaker is OFF or not installed.
2. Remove detachable terminal block.
3. Insert load and load return wires. Strip 0.4 in (10 mm) 8 AWG (6 mm²) max.
4. Torque to 6.5 in-lb (0.75 Nm).
5. Pull wires to verify.
6. Insert detachable terminal block fully.

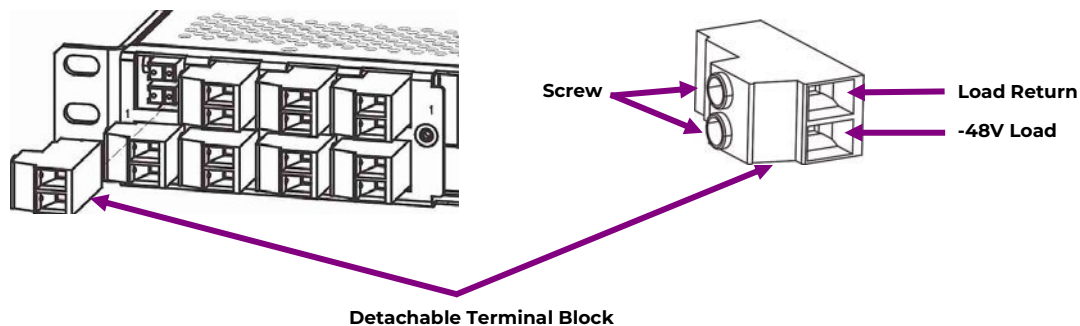

Note: Snapak Breaker Connections may be in front or back depending on configuration.

Step 9 – Connect GMT Style Fuse Loads - skip if not present

Connections for Load GMT Fuses to GMT terminal blocks identified as “-48VDC” and “RTNS” on labels above each row of terminals blocks.

Wire Size: 24-12AWG Strip Length: 0.35” (9mm)

1. Verify that fuse is not installed.
2. Strip wires.
3. Insert wires into terminal blocks labeled -48VDC and associated RTNS.
4. Tighten screw - 4 in-lb (0.45 Nm).
5. Pull wire to verify.

Step 9 – Connect GMT Style Fuse Loads - skip if not present (continued)

6. Reposition the Tie Bar to the bottom of the distribution shelf if desired - 2 screws.
7. Secure wires to Tie Bar.

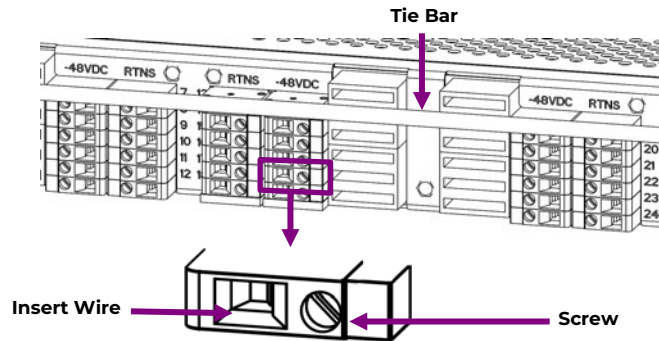

Step 10 – Label Connections

1. Mark each connected circuit identification on the ID label.
2. Snap the ID Label onto the Tie Bar or insert into slot in front of distribution face.

CIRCUIT BREAKERS		FUSED OUTPUTS (I-ISA)		FUSED OUTPUTS (I-ISA)		CIRCUIT BREAKERS	
CB1	F1	F7	F8	CB3			
	F2	F8	F9				
	F3	F9	F10				
CB2	F4	F10	F11	CB4			
	F5	F11	F12				
	F6	F12					

FUSED OUTPUTS (I-ISA)		FUSED OUTPUTS (I-ISA)		FUSED OUTPUTS (I-ISA)	
F1	F7	F13	F19	F25	F31
F2	F8	F14	F20	F26	F32
F3	F9	F15	F21	F27	F33
F4	F10	F16	F22	F28	F34
F5	F11	F17	F23	F29	F35
F6	F12	F18	F24	F30	F36

ID Label Example

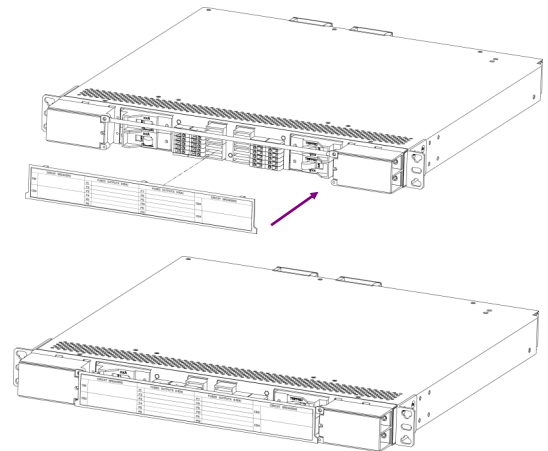

Step 11 – Install Breakers and Fuses

Install breakers and fuses into positions as specified in Site Engineering Instructions.

Bullet Breakers

CAUTION:

1. Install breakers oriented as shown. Orientation is different for Left and Right breakers.
2. Install proper breaker type in Battery and Load positions.
 - Battery Breakers (Yellow handle) in Battery Position (Right positions only).
 - Load Breakers (Black handle) in Load Positions (Right and Left positions).
3. Remove Retention Cover (2 screws).
4. Verify that each Breaker is OFF.
5. Insert each Breaker fully into its position. Orient as shown below.

Step 11 – Install Breakers and Fuses (continued)

6. Remove cover knockouts for installed positions.
7. Replace Cover (2 thumb screws).
8. Turn each Breaker ON.

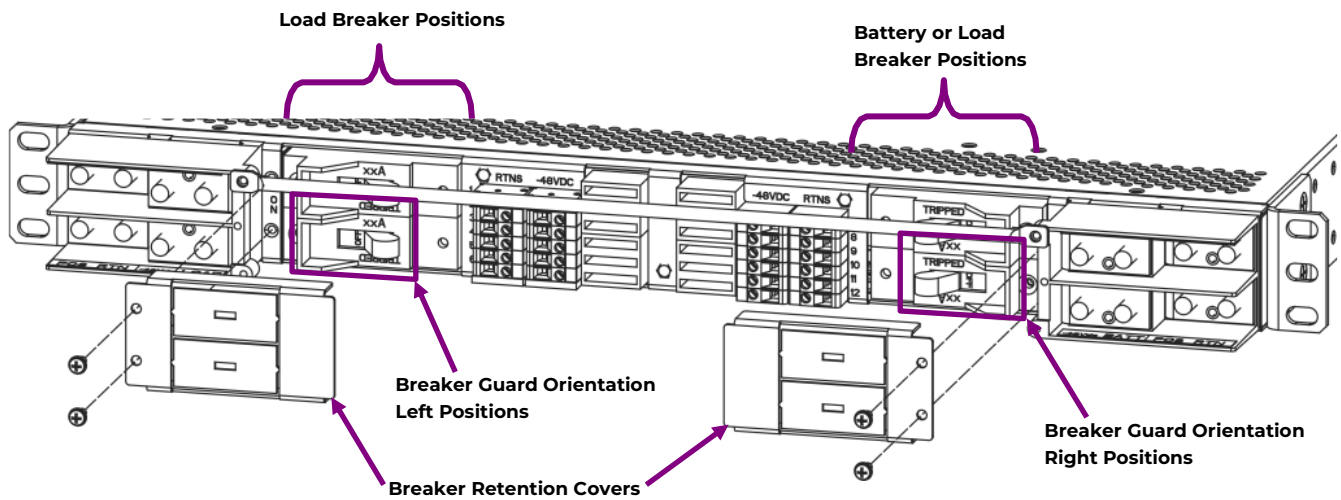

Snapak Breakers

1. Remove Cover (2 thumb screws)
2. Verify that each Breaker is OFF.
3. Insert each Breaker fully into its position.
 - Orient with ON position at top.
4. Remove cover knockouts for installed positions.
5. Replace Cover (2 thumb screws)
6. Turn each Breaker ON.

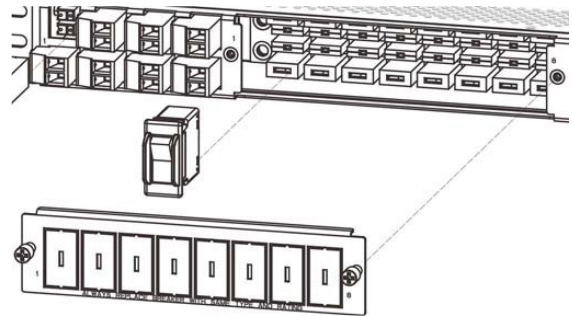

GMT Style Fuses

1. Insert each GMT style fuse fully into its position.
 - Orient as shown.

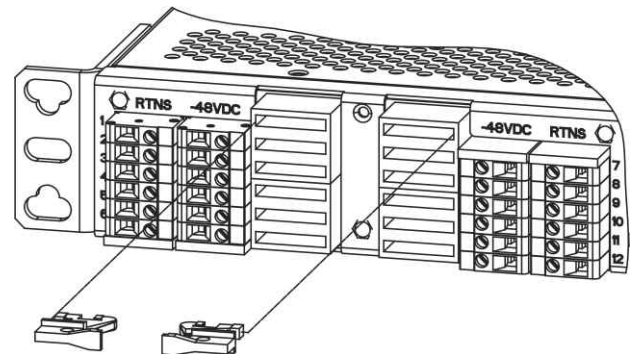

Step 12 – Install System Controller - skip if not present

CAUTION: The System controller contains static sensitive components; Care should be taken to not contact components with bare hands.

1. Remove GCP841A_016R_S_BL Pulsar Edge Controller from shipping box and anti-static bag.
2. Set Jumpers – LAN Port and Alarm Relay.

Before installing the controller configure the jumpers – top or side of the controller.

Controller Jumper Settings		
LAN Port - J5	<p>Local (Server): J5 LAN connects to a laptop. Local (Server) is a temporary setting, once configuration is complete move the jumper back to Network (Client) mode. Configure and view system parameters using software or a web browser. Default IP address is 192.168.2.1. The default administrator password is "administrator".</p> <p>CAUTION: Do not connect LAN port to a network when jumper is set to Local.</p>	<p>Network (Client): J5 LAN connects to a network.(Default).</p>
Alarm Relays	<p>Alarm Relays can be set to operate as Close on Alarm or Open on Alarm. Open on Alarm is the Factory Default setting.</p> <p>Move Alarm jumpers to Close on Alarm when required. The number of alarm relays in a controller is indicated in the model number as an R.Example: MODEL: CP841A_016R has 6 alarm relays - PMJ, PMN, 1, 2, 3, and 4. Relays 1 -4 are factory defaulted to specific system alarms and can be user reconfigured as needed.</p>	

Alarm contacts provided are not fused within the subject power distribution shelves. Current limiting protection for these contacts must be provided by external circuits and limit the input to a maximum of 0.5A at 60Vdc.

Controller Jumper Location (Side or Top)

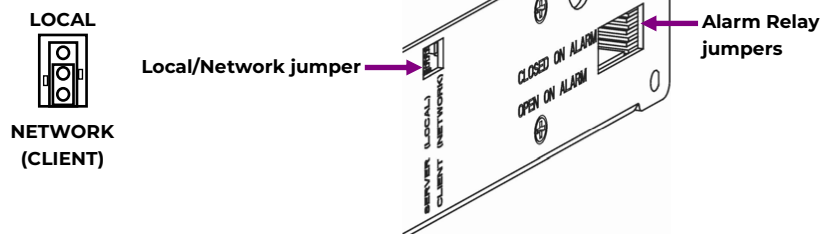

Alarm Relay Jumpers Examples

Controller Type	Factory Settings
016R (6 Relays)	

3. Set Shelf IDs – per shelf Quick Start Guides – Some shelves.
Shelf ID switches and jumpers are located on the rear of some rectifier shelves.
Shelf models – see shelf quick start guides for location.
Shelf ID must be unique and in the range of 1 to F.
Set rectifier shelf IDs in sequence beginning with 1 at the top shelf.

ID	Shelf
1	Top
2	
4	
3	

Step 12 – Install System Controller - skip if not present

4. Slowly slide the controller into the controller slot on the left side of the distribution.
5. With the controller partially inserted, open the latch on front of the controller and continue to insert until it has firmly seated into the shelf.
6. Close the controller latch to ensure it is fully inserted and retained in the shelf.

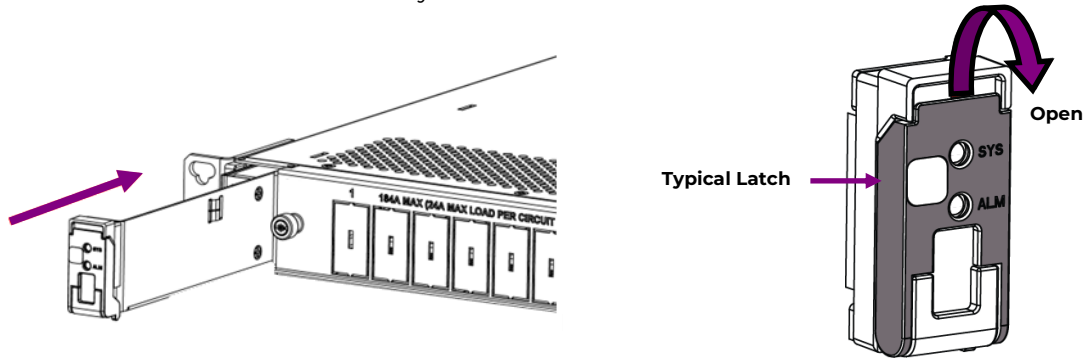

Step 13 – Additional Configuration

Install Signal and Communication Cables

Communication cables are connected at the rear of system.

Install communications cables as instructed in equipment documentation and in site engineering instructions.

See Information: Connectors.

System Initial Start Up

Power the controller – follow the system start up procedure as instructed in equipment documentation and in site engineering instructions.

Configure Controller

Verify and edit controller basic configuration parameters per site engineering instructions.

CAUTION:

1. DHCP/Static IP Address – set per site engineering instructions to assure network access.
2. Rectifier float Voltage Set Point – Set both Rectifier Internal Selective High Voltage Shutdown and Rectifier High Output Voltage Minor Alarm and Rectifier Very High Voltage Major Alarm higher than desired Rectifier Voltage Set Point. before setting Rectifier Voltage Set Point. Rectifiers will not operate when either of these parameters is set to less than the Rectifier Voltage Set Point.

See Information: Basic Operation

Basic Configuration – minimum for operation and communication.

Basic Configuration through Web Browser And Front Panel Display Interfaces

Parameter	Browser	Display Menu
Controller		
System Date, System Time	Installation tab	Configuration > System Settings
Site ID, Site Description	Installation tab	Browser
Shelf J-Code or Product Code	Installation tab	Browser
DHCP / Static IP Address	Network page (Settings tab, Communications group)	Configuration > Communications Ports > Network Settings
Shelves	Shelves page (Settings tab, System group)	Browser

Step 13 – Additional Configuration (continued)

Advanced Configuration

Complete site specific configuration. Verify and edit remaining controller parameters per site engineering instructions.

Information: Controller Default Voltage Settings and Ranges

Configure these parameters per site engineering instructions.
See Quick Start Guide Supplements for customer specific Default Settings.

Rectifier Management Standard Default Voltage Settings and Ranges ¹	Range	48V Default ¹ Valve-Reg
Float Voltage	42 to 56.5V	54.48
Rectifier Float Selective High Voltage Shutdown	-50 to -60V	58.50
High Float Voltage Major Alarm	-50 to -60V	57.00
High Float Voltage Minor Alarm	-50 to -60V	56.00
Rectifier/System Float Voltage	-42 to -56.5V	54.48
Rectifier On Threshold	-40 to -51V	44.00

¹Customer specific factory defaults - see the Quick Start Guide Supplement.

Information: Connectors

See equipment Quick Start Guides and Quick Start Guide Supplements for details of connector, factory signal assignments, and available cables. Connectors are on the primary shelf (equipped with controller), usually at the rear. Physical styles and locations of system mounted connectors are system specific. Not all connectors are present on all systems.

Connector	Label	Position ²	Function	Connect to
J3/J4 (RJ – 45)	DATA	Upper	1 – Wire	1-Wire devices
		Lower	OmniOn Device Comm	Compatible shelves via Daisy Chain
J5 (RJ – 45)	LAN		10/100Base – T	Network or Local PC
J7	DIST		Distribution Signals	Compatible Distribution Shelf

²DATA connectors (J3 and J4) are usually positioned one above the other. Use only the upper connector for 1-Wire devices. See equipment Quick Start Guide.

Information: Alarms - Power Minor (PMN) and Power Major (PMJ)

PMN and PMJ are system severity alarms.
PMN reports during every minor alarm condition.
PMJ reports during every major alarm condition.

Information: Basic Operation

<p>Controller LEDs – Alarm Status: SYS: Green = Normal Amber = Minor Alarm Red = Critical/Major Alarm ALM: Red = certain user assigned alarms</p>	<p>System Parameters: View and change from the factory defaults via: A. LAN port in Local mode via a laptop (web pages). B. Network (web pages). C. Controller Display Panel – on some models. Details in Pulsar Edge Controller Family Product Manual.</p>	<p>LAN port Local or Network Set by the jumper setting shown on page 15.</p>
-------------------------------------------------------------------------------------------------------------------------------------------------------------------	-------------------------------------------------------------------------------------------------------------------------------------------------------------------------------------------------------------------------------------------------------------------------	----------------------------------------------------------------------------------

<p>Connect PC via LAN Port</p> <ol style="list-style-type: none"> 1. Set LAN port to Local – jumper setting shown on page 15. 2. Connect laptop PC to LAN port. 3. Follow: View and Change - Web Page procedure listed below 4. Set LAN port to Network mode and connect network cable to restore network access. 	<p>Connect PC via Network</p> <ol style="list-style-type: none"> 1. With LAN port set to Network (page 15). 2. Open a browser on a network connected PC. 3. Follow Operation Web Page.
-------------------------------------------------------------------------------------------------------------------------------------------------------------------------------------------------------------------------------------------------------------------------------------------------------------------------------------------------------------	-------------------------------------------------------------------------------------------------------------------------------------------------------------------------------------------------------------------------

Step 13 – Additional Configuration (continued)

View and Change – Web Page

1. Connect via browser – default IP address 192.168.2.1
2. Login to the controller – username is not required by default.
 - Access (Default Username) Default Password
 - Read – Only (none) Lineage
 - Read/Write (none) Super – user
 - Read/Write/Password Administration (“admin”) administrator
3. Select the desired tab – Installation and Settings tabs for configuration.
4. Select the desired item from the items grouped in columns.
5. View and change system parameters as instructed in equipment documentation and in site engineering instructions.
6. Following are the typical web screens for configuring system configuration and basic rectifier parameters.

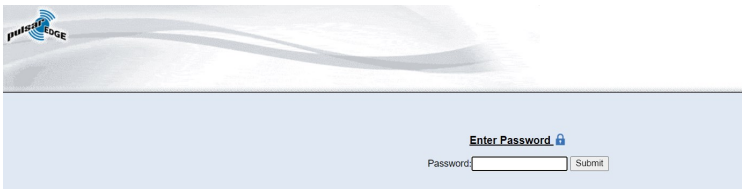

Web Login Page

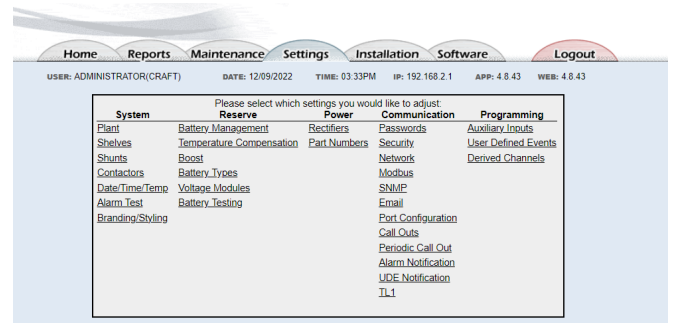

Web Settings Page

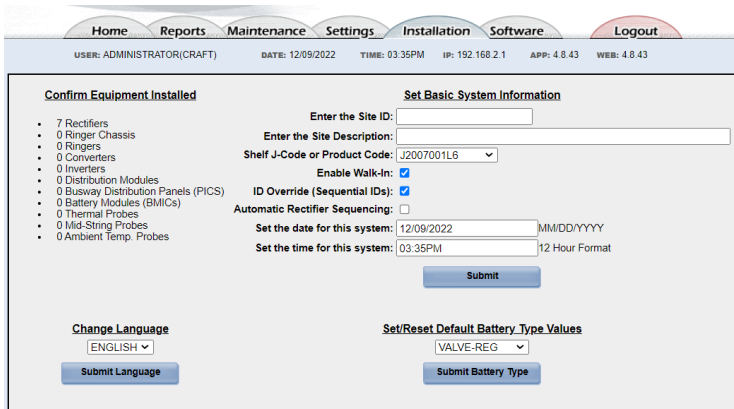

Web Installation Page

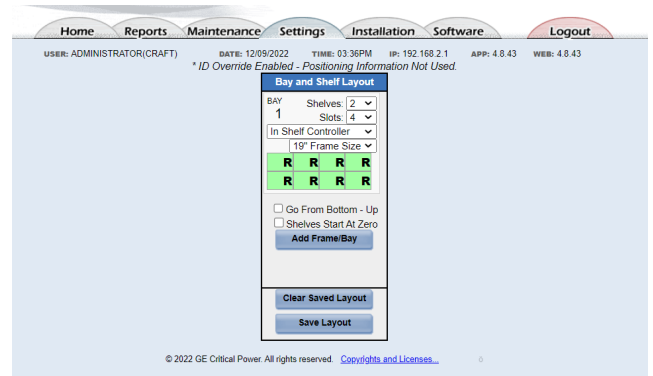

Web Bay And Shelf Layout

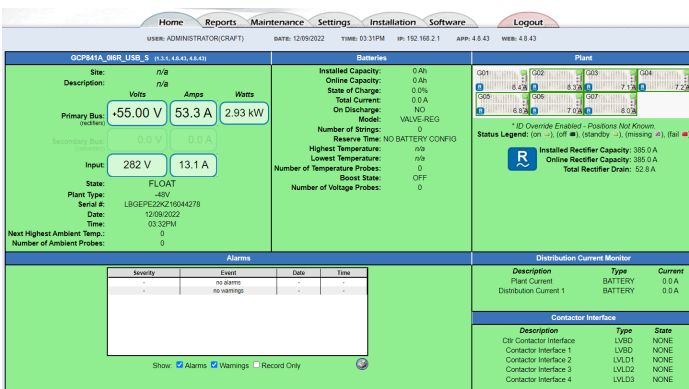

Web Home Page Example (Two shelf system)

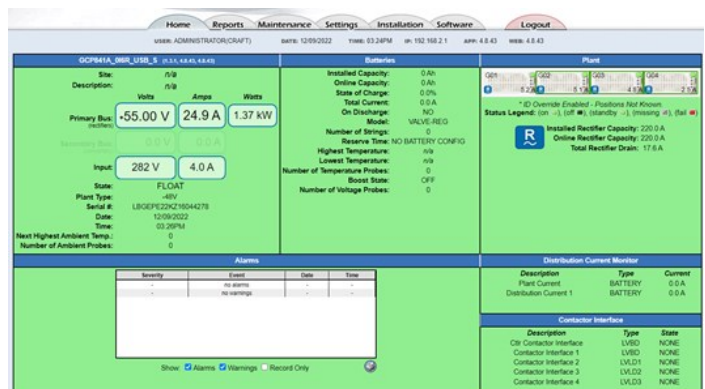

Web Home Page Example (Single shelf system)

Step 13 – Additional Configuration (continued)

Clear Missing Devices/Uninstall Equipment Operation

Some alarms may indicate that a previously connected device is no longer connected, e.g. Communication Fail.

Use the Clear Missing Devices operation to remove the devices from controller memory to clear these alarms.

Web: Maintenance Tab > Clear Data column: clear missing devices

Display Menu: Control/Operations > Uninstall Equipment - only clears missing devices (same as previous).

Connecting a device to the controller automatically adds it to the connected device memory.

Information – Troubleshooting DC System (1)		
Controller LED	Possible Problem	Possible Solution
AMBER	Single Rectifier not receiving ac power. AC input circuit breaker has opened.	Verify ac power to rectifier is available. Verify rectifier input circuit breaker is closed. If problem not corrected, replace rectifier.
RED	Multiple rectifiers not receiving ac power. AC input circuit breakers have opened.AC input voltage is out of range.	Verify ac power to rectifiers is available. Verify rectifier input circuit breakers are closed.If problem not corrected, replace rectifier.
AMBER or RED	A rectifier, multiple rectifiers, or the entire system has lost AC and one or more rectifiers have been removed from the system while under this condition.	Verify that ac power to all rectifiers is available.Verify that rectifiers all report good AC. Issue the uninstall equipment under the operations menu for anyrectifier that may have been removed
RED	Rectifier output voltage has fallen below the battery on discharge threshold set by the user.	If commercial ac power is present but the system voltage remains low,call your local field representative. Investigate other alarms that may be present such as
AMBER	Rectifier output has dropped below 36V, rectifier has entered hiccup mode.	Replace rectifier.
RED	All rectifier outputs have dropped below 36V, all rectifiers have entered hiccup mode.	Remove controller; if output voltage does not go to set – point previously set by user, call your local field representative.
None	Controller failure, all devices on the communication bus reporting loss of communication with controller.	Check controller to ensure it is properly inserted into its slot. If so,perform the following steps: Remove the controller board for 1 minute and then reset. If problem persists, replace controller with new controller board. If problem still persists, call your local field

Information - Troubleshooting DC System (2)			
Controller LED	User Interface Display	Possible Problem	Possible Solution
AMBER	MIN, Thermal Probe Fail	1-Wire thermal probe failed	<p>Ensure thermal probe is properly connected to thermal probe cable.</p> <p>Ensure cable is properly connected to the rear of the Distribution Module.</p> <p>If problem persists, replace thermal probe per ensuing instructions. If problem still persists, call your local field representative.</p>
RED	MAJ, Fuse Major	One or more of the output circuit breakers or fuses have opened.	Reset circuit breakers or replace fuse.
AMBER	MIN, Rectifier Fail	<p>Single rectifier thermal alarm:</p> <p>Excessive ambient temperature</p> <p>Multiple rectifier failure</p>	<p>Verify that there is no obstruction of the airflow path.</p> <p>Reset the rectifier by removing the rectifier, waiting approximately 30 seconds, and replacing the rectifier</p>
RED	<p>MIN, Rectifier Fail</p> <p>MAJ, Multiple Rectifier Fail</p>	<p>Multiple rectifier thermal alarm:</p> <p>Excessive ambient temperature</p> <p>Multiple rectifier failure</p>	<p>If problem persists, replace the rectifier.</p> <p>If problem still persists, call your local field representative</p>
AMBER	MIN, Rectifier Fail	Communication failure from Rectifier Module to Controller	<p>Verify communication cable connection</p> <p>Verify the Shelf ID</p> <p>Reset the rectifier by removing the rectifier, waiting approximately 30 seconds, and replacing it back</p> <p>If problem persists, replace the rectifier</p> <p>If problem still persists, call your local field representative</p>
RED	MAJ, High Voltage	<p>High output voltage from rectifier(s)</p> <p>High voltage shutdown Internal rectifier (s) failure</p>	<p>Reset the rectifier(s) by removing the rectifier (s), waiting approximately 30s and replacing the rectifier(s).</p> <p>If problem persists, replace the rectifier.</p> <p>If problem still persists, call your local field representative.</p>
AMBER	MIN, Clock Battery Low	Internal Lithium Battery Is Low	<p>The battery from controller unit should be replaced.</p> <p>Call tech support: 1-577-546-3243</p> <p>Obtain all desired information such as alarm history, statistics, and any field configuration that is different than the standard.</p>
AMBER	MIN, Minor Communication Fail	Rectifier lost communication with controller	<p>If a rectifier has been removed from an installed/operational system, go to the Control/Operations menu and execute Uninstall Equipment.</p> <p>Reset the rectifier by removing the rectifier, waiting approximately 30 seconds, and replacing.</p> <p>If problem persists, replace the rectifier.</p> <p>If problem still persists, call your local field representative.</p>

Information – Troubleshooting DC System (3)		
Controller LED	Possible Problem	Possible Solution
GREEN	One or both of the QS871A shunt inputs is open – circuit	<p>Verify that the respective shunt has its green and yellow wire Connections attached used for the current measurements.</p> <p>Verify the shunt connection to the QS871A is good by verifying the green and yellow wire connections from the shunt follows through to the 10 – pin connector at the respective QS871A.</p>
GREEN	AC present, not within operating limits	<p>Verify AC input voltage.</p> <p>Reset the rectifier by removing the rectifier, waiting approximately 30seconds, and replacing the rectifier.</p> <p>If problem persists, replace the rectifier.</p> <p>If problem still persists, call your local field representative.</p>
GREEN	Rectifier Over Load – Current or Power	<p>If problem persists: Reset the rectifier by removing the rectifier, waiting approximately 30 seconds, and replacing the rectifier.</p> <p>If problem persists, replace the rectifier.</p> <p>If problem still persists, call your local field representative.</p>
GREEN	Rectifier Standby (Normal during some conditions depending on controller settings.)	<p>Verify controller settings.</p> <p>If problem persists: Reset the rectifier by removing the rectifier, waiting approximately 30 seconds, and replacing the rectifier.</p> <p>If problem persists, replace the rectifier.</p> <p>If problem still persists, call your local field representative.</p>

Step 14 – Controller Shunt and Contactor Settings - if battery connections are present

Details in Pulsar Edge Controller Family Product Manual.

Shunt size and contactor option label is on the side of the Battery Lug Landing assembly.

Verify settings as specified in Site Engineering Instructions.

Verify Battery Shunt Settings:

- A. Controller Display - Follow the menu path; Menu > Configuration > Shunt Monitors > Built In - edit as necessary.
- B. Web Pages - Select the Settings Tab > Shunts > Plant Shunt - edit as necessary.

Verify Disconnect Contactor Settings - if disconnect contactor is present:

- A. Controller Display - Follow the menu path; Menu > Configuration > Contactor Interfaces > Built In - type "LVBD" or "LVLD"; and Menu > Configuration > Disconnects > LVBD or LVBD 1-3 - edit as necessary.
- B. Web Pages - Select the Settings Tab > Contactors > DCNC1 - type "LVBD"; Select Edit button, edit settings as necessary.

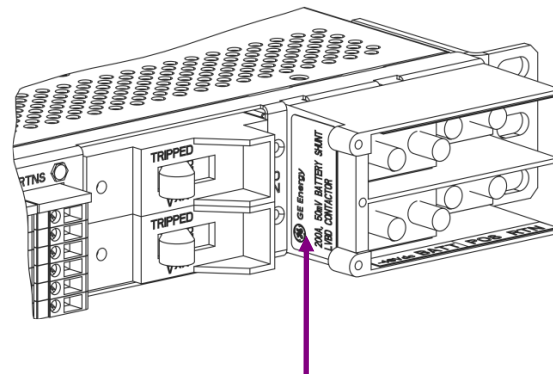

**Shunt Size and Disconnect
Contactor option label**

Reference Documents

These documents are available at omnionpower.com

Document	Title
CC848815341	Pulsar Edge Controller Family Product Manual
	Infinity S Power System (NE-S) Brochure and Ordering Guide
	Slimline Power System (SPS) Brochure and Ordering Guide
	Cabinet Power System (CP) Brochure and Ordering Guide

Ordering Information

Please contact your OmniOn Sales Representative for pricing, availability and optional features.

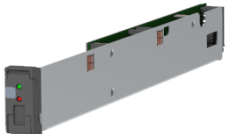
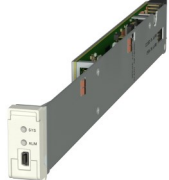
Ordering code	Description	Picture
1600422358A	GCP841A_016R_S_BL Pulsar Edge Controller	
150043558	GCP841A_016R_S Pulsar Edge Controller	

Bullet Style Load Circuit Breakers

Ordering Code	Amperage	CB Positions (Poles)	Min Wire Gauge	Picture
407998137	3	1	10	
407998145	5	1	10	
407998152	10	1	10	
407998160	15	1	10	
407998178	16	1	10	
407998186	20	1	10	
407998194	25	1	10	
407998202	30	1	10	
408213486	40	1	10	
407998210	45	1	8	
407998228	50	1	8	
407998236	60	1	6	
407998244	70	1	6	
407998251	80	1	4	
407998269	90	1	4	
407998277	100	1	2	

Snapak® Plug-in Breakers

Ordering Code	Amperage	Picture
450017886	1	
450023452	2	
450023455	3	
450023456	4	
450017887	5	
450023457	6	
450023460	7.5	
450023461	10	
CC408648884	15	
CC408651252	20	
450023462	25	
CC408638605	30	

Ordering Information (Continued)

GMT Fuses

Ordering Code	Amperage	Picture
407715713	0.18	
4600218580P	0.25	
4600483302P	0.5	
4600483303P	1	
406530725	1.33	
406421032	2	
406204230	3	
406203976	5	
4600483304P	7.5	
406203190	10	
407845197	12	
450036522	15	

Bullet Style Battery Circuit Breakers

Ordering Code	Amperage	Picture
CC408612758	30	
CC408612766	40	
CC408612774	45	
CC408574370	50	
408560123	60	
CC408574387	70	
CC408574395	100	

Notes:

OmniOn Power Inc.

601 Shiloh Rd.
Plano, TX USA

omnionpower.com

We reserve the right to make technical changes or modify the contents of this document without prior notice. OmniOn Power does not accept any responsibility for errors or lack of information in this document and makes no warranty with respect to and assumes no liability as a result of any use of information in this document.

We reserve all rights in this document and in the subject matter and illustrations contained therein. Any reproduction, disclosure to third parties or utilization of its contents – in whole or in parts – is forbidden without prior written consent of OmniOn Power. This document does not convey license to any patent or any intellectual property right. Copyright© 2023 OmniOn Power Inc. All rights reserved.