

ORDERING GUIDE

GPS 4830 Power System

-48V DC Large Power Plant in Distributed Architecture



Table of contents

3	Overview
4	Cabinet Specifications
6	GP100 Rectifier Specifications
9	Galaxy Millennium II Controller
13	Galaxy Pulsar Plus Controller
16	Ordering Information - GPS4830 Power System
37	Management Visibility, Training, Service & Support, Warranty

Overview

The GPS4830 combines the benefits of the new high efficiency GP100 rectifier with the time tested cabinet design and distribution found in the GPS4848. Utilizing the 1RU GP100 48 VDC rectifier, a fully equipped bay populated with 12 rectifier shelves (24 rectifiers) allows for as much as 144 kW of power in a mere 25 inches of vertical space, leaving 44 inches of space for installation of distribution panels.

Cabinet Options

The 4830 system can be deployed with capacity of up to 2760 amps @ 52 VDC in a single cabinet or expanded over multiple cabinets. It is designed for either internal input AC breakers or terminal strip AC input. Several rectifier AC terminations options are available. See details under the cabinet specifications. Rectifier shelves can be spread across multiple bays or concentrated to a single bay. For greater flexibility and working space, the 4830 may be combined with a larger 36 inch wide distribution bay to accommodate large cable termination and egress.

Rectifier Options

The GPS4830 utilizes the highly efficient (96.5%) GP100 rectifier with either high line 380/480 VAC input (H3 option) or low line 200/208/240 VAC input (L3 option). Both rectifier versions provide 6kW output at 48 VDC nominal.

Controller Options

Galaxy Millennium II

The Galaxy Millennium II controller combines sophisticated power monitoring and remote management. This controller simplifies operations and maintenance while lowering administrative costs supporting up to 72 rectifiers. With the addition of a bay interface card (BIC 11), multiple cabinets can be banked together to increase overall power output to meet demands, and also allow for future expandability. Remote peripheral modules (RPM) can support over 500 monitoring points for ABB or third party devices. Ethernet, SNMP, Modbus RTU, and TL1 provide integration with power engineering and NOC workflow.

Galaxy Pulsar Plus

As an economical alternative, the GPS4830 can be equipped with the Pulsar Controller. It is designed to monitor and control system components including rectifiers, and distribution modules via a multi-drop RS485 digital communications bus. System status, parameters settings, and alarm thresholds can be viewed and configured from the controller's front panel or local/remote PC interface. The Pulsar Plus option is only available with single bay systems that do not have contactors or require remote peripheral modules (RPM).

Advantages

- GP100 rectifier based configurations
- Up to 2,760A @ 52 VDC capacity per bay w/ GP100L3 rectifiers
- Overall system capacities in excess of 12,000 amps
- Galaxy Pulsar Plus or Galaxy Millennium II controller options
- 480 or 208 VAC “true” 3-phase input options

Cabinet Specifications

Mechanical

Height	84.0 inches (2,134mm)
Weight	23.6 inches (600mm)
Depth	23.6 inches (600mm)

Thermal

12 Rectifiers (GP100H3 / GP100L3) @ 100% load	3000 W (10,236 BTU/hr) / 3,792W (12,939 BTU/hr)
24 Rectifiers (GP100H3 / GP100L3) @ 100% load	6000 W (20,472 BTU/hr) / 7,584W (25,878 BTU/hr)

Environmental

Operating Temperature Range	0°C to +43°C (32°F to 113°F)
Operating Relative Humidity	< 95% non-condensing
Storage Temperature Range	-40°C to +85°C (-40 to 185°F)
EMC	FCC and CISPR32 (EN55032) Class A
Immunity	GR1089, EN55024

Agency Certifications

UL	Canada/US UL62368/UL1801
EMI/EMC	CISPR class A conducted and radiated
NEBS Level 3	Evaluated by independent NRTL test lab to Telcordia GR63, Issue 3 & GR 1089, Issue 5.

Outline Drawing

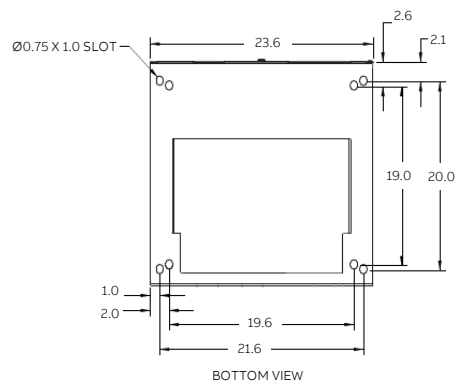
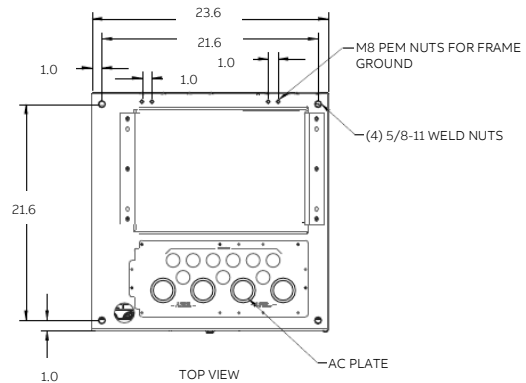
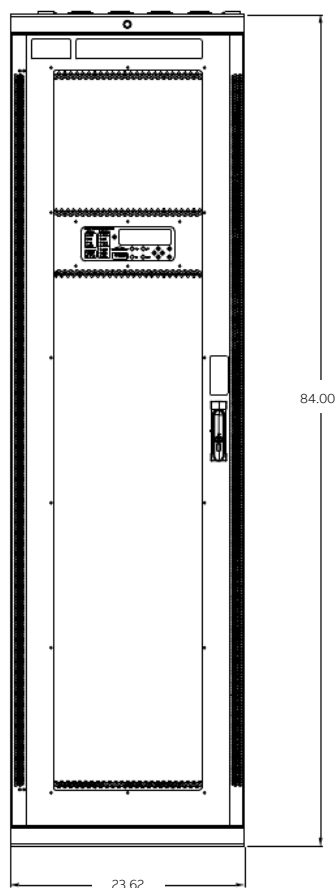

AC Input Specifications: Terminal Block Panel Connection to Rectifier

GROUP CODE NUMBER	# OF RECT	# OF RECT SHELVES	# OF AC FEEDS	NOMINAL RECT VOLTAGE (VAC)	# FEED / RECTIFIER	ARCH TYPE	CABLE INPUT - CABLE EXIT
304A	8	4	4	480	1 / 2		
304B	8	4	2	480	1 / 4		
304C	8	4	8	480	1 / 1		
306A	12	6	6	480	1 / 2		
306B	12	6	3	480	1 / 4		
306C	12	6	12	480	1 / 1		
308A	16	8	8	480	1 / 2		
308B	16	8	4	480	1 / 4	DISTRIBUTED	TOP AC -TOP DC
308C	16	8	16	480	1 / 1		
310A	20	10	10	480	1 / 2		
310B	20	10	5	480	1 / 4		
310C	20	10	20	480	1 / 1		
312A	24	12	12	480	1 / 2		
312B	24	12	6	480	1 / 4		
312C	24	12	24	480	1 / 1		
634	24	12	6	480	1 / 2	HYBRID	TOP AC - BOT DC LOAD - TOP BATT
364A	8	4	4	208	1 / 2		
364C	8	4	8	208	1 / 1		
366A	12	6	6	208	1 / 2		
366C	12	6	12	208	1 / 1		
368A	16	8	8	208	1 / 2	DISTRIBUTED	TOP AC -TOP DC
368C	16	8	16	208	1 / 1		
370A	20	10	10	208	1 / 2		
370C	20	10	20	208	1 / 1		
372A	24	12	12	208	1 / 2		
372C	24	12	24	208	1 / 1		
734A	24	12	12	208	1 / 2		
743C	24	12	24	208	1 / 1	HYBRID	TOP AC - BOT DC LOAD - TOP BATT

AC Input Specifications: Internal Circuit Breaker Panel Connection to Rectifier

GROUP CODE NUMBER	# OF RECT	# OF RECT SHELVES	# OF AC FEEDS	NOMINAL RECT VOLTAGE (VAC)	# AC CIRCUIT BREAKERS / SIZE (AMPS)	ARCH TYPE	CABLE INPUT - CABLE EXIT
334A	8	4	1	480	4 / 25		
334B	16	8	1	480	4 / 50	DISTRIBUTED	TOP AC -TOP DC
346A	12	6	2	480	6 / 25		
346B	24	12	2	480	6 / 50		
352A	24	12	4	480	12 / 25	CENTRALIZED	TOP AC - TOP DC
646B	24	12	2	480	6 / 50	HYBRID	TOP AC - BOT DC LOAD - TOP BATT
384A	8	4	1	208	4 / 50		
386A	12	6	2	208	6 / 50	DISTRIBUTED	TOP AC -TOP DC
746A	12	6	2	208	6 / 50	HYBRID	TOP AC - BOT DC LOAD - TOP BATT

Rectifiers

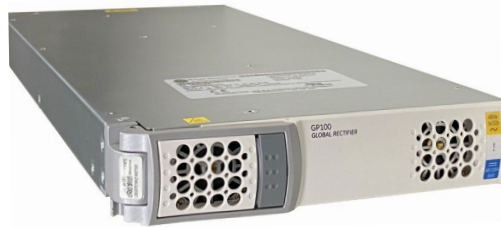

Overview

The GPS4830 family of products are structured around two classifications of power rectifiers dependent on the input voltage available. Both versions provide for 48 VDC nominal output. Refer to specifications for more details.

- GP100H3R48TEZ: 3 Φ , 380/480 VAC Input
- GP100L3R48TEZ: 3 Φ , 200/208/240 VAC Input

Key Features

- Developed for extended temperature ranges
- Redundant fan cooling
- 1U height, hi power density
- RoHS compliant
- Digital load sharing over robust RS485 communications
- Front panel LED indicators
- Wide range AC input
- 48V back bias
- Hot pluggable

Features

- Compact 1RU form factor provides high power density of 27 watts/in³
- Plug and play with automatic ID - installation of the rectifier in a shelf connected to a compatible system controller initializes all set up parameters and IDs shelf position automatically. No adjustments are needed. Product identifications, serial numbers and software versions are provided in the embedded inventory report page.
- Monitoring / control – the built in microprocessor controls and monitors all critical rectifier functions and communicates with the system controller using the built in Galaxy Protocol serial interface.
- Efficient with 95.5 % peak efficiency
- Balanced draw from each of the three AC input phases
- 6,000 Watts at 48 VDC from three wire 3 Φ 200 to 240 VAC (no neutral is needed)
- Constant power for output voltages from 48 to 58 VDC (Output voltage programmable)
- Operates over a broad temperature range: -10°C through +75°C (Output derates at 2% per °C beginning at +50 °C)
- Fail safe performance – Internal faults isolated from output bus; hot insertion capabilities allow for rectifier replacement without system shutdown; soft start and inrush current protection prevent nuisance tripping of upstream breakers
- Extended service life – parallel operation with automatic load sharing ensures that units are not unduly stressed
- Simple Human Factors – 3 front panel LEDs indicate AC good (Green), DC good (Green) or Fault (Red)

Rectifier Specifications

INPUT		GP100L3R48			GP100H3R48			Unit
Parameter	Symbol	Min	Typ	Max	Min	Typ	Max	Unit
Operating Voltage Range (3Ø delta with safety frame ground)	V_{IN}	180	208/ 240	275	320	480	530	VAC
Frequency	F_{IN}	47	50/60	63	47	50/60	66	Hz
Input Current (@ max load)								
@208 VAC 3p			18					
@240 VAC 3p	I_{IN}		15					A
@380 VAC 3p						10		
@480 VAC 3p						8		
Power Factor (50 – 100% load)	PF	0.98	0.995		0.96	0.995		
Efficiency Peak	h		95.0			96.5		%
Total Harmonic Distortion @loads over 50%			<5			<5		%
OUTPUT		GP100L3R48			GP100H3R48			Unit
Parameter	Symbol	Min	Typ	Max	Min	Typ	Max	Unit
Output Power								
		(200 – 240 VAC-3Ø)		6050				W
		(380 – 480 VAC-3Ø)					6000	W
Voltage Nominal			52			52		VDC
Output Voltage - Set by firmware		42		58	42		58	VDC
Overall regulation (with controller)	V_{OUT}		±0.05			±0.05		%
Output Current @ 52 VDC, $T_{amb} = 45^{\circ}C$	I_{OUT}		115			115		A
Output Ripple (10-100% load)	V_{OUT}			250			250	mV _{p-p}
Heat Dissipation @ Max Out			316			250		W
			1080			853		BTU
Power Density			27			27		W/in ³
Environmental		All Versions						
Operating Temperature	-40°C to +75°C (Output derates at 2%/°C beginning at 50°C)							
Storage Temperature	-40°C to +85°C							
Operating Relative Humidity	0 - 95% (non-condensing)							
Electromagnetic Compatibility	FCC Part 15, EN 55032 (CISPR32), EN 55024, Level A, GR-1089							
Cooling Method	Front to back airflow with onboard temperature controlled fans							
Mean Time Between Failure (MTBF)	1,180k hours @ 25°C per Telcordia Issue 4 (GP100L3) 560k hours @ 25°C per Telcordia Issue 4 (GP100H3)							
Altitude (Operating at rated values)	1524/5000 m/ft; power derates above 1524/5000 m/ft. Max 3962/13,000 m/ft							

Rectifier Specifications (Continued)

Mechanical	All versions
Height (inch/mm)	1.61 / 41
Width (inch/mm)	7.97 / 202
Length Or Depth (inch/mm)	17.36/441
Weight (lb/Kg)	9.5 / 4.3

Safety and Standards Compliance

Safety	CE Mark to Low Voltage Directive 2006/95/EC and EMC Directive 2004/108/E (Rectifiers only) UL 62368-1, 2nd Ed. Recognized CSA C22.2 No. 62368-1-07, 2nd Ed. + A1:2001 (MOD)
RoHS	Compliant to RoHS EU Directive 2002/95/EC; RoHS 6/6
EMC	European Directive 2004/108/EC; EN55032, Class A; EN55024; FCC, Class A; GR1089-CORE
ESD	EN61000-4-2, Level 4
NEBS Level 3	Evaluated by independent NRTL test lab to Telcordia GR63 CORE & GR 1089 CORE

Outline Drawing

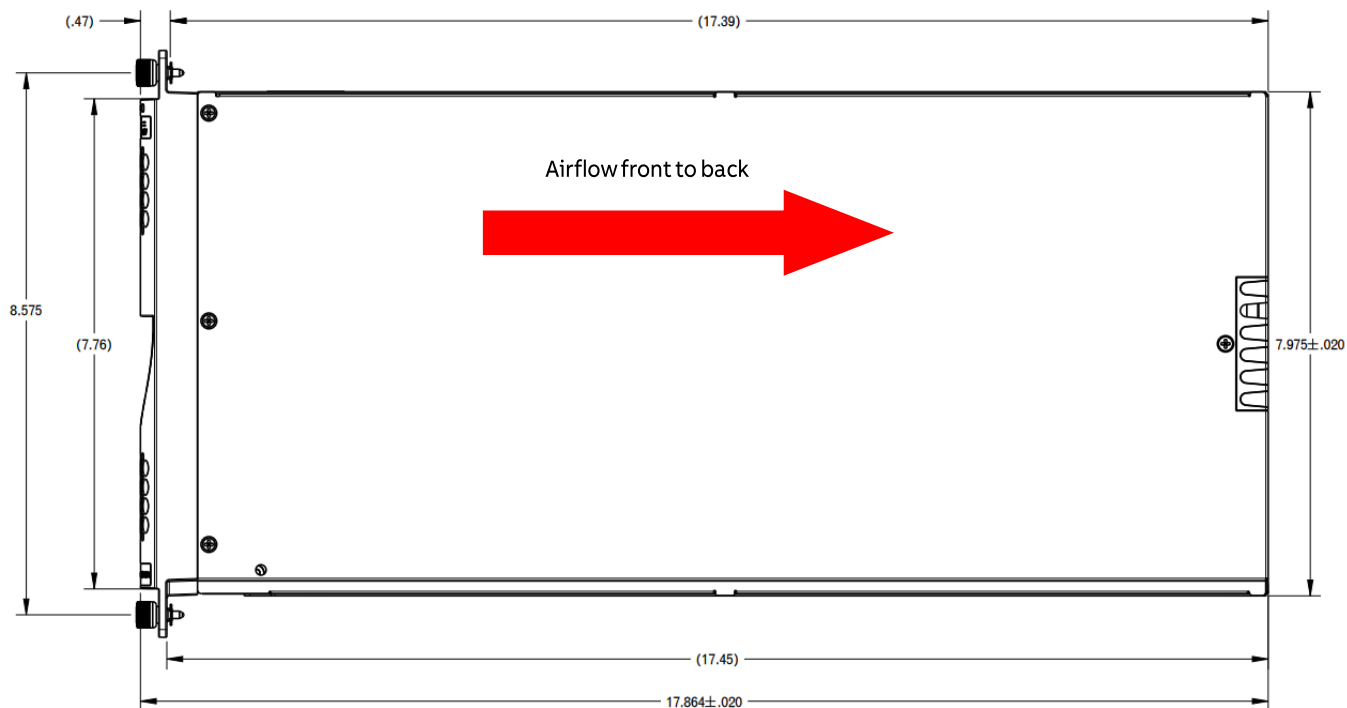

Controllers

Galaxy Millennium Controller II™ Controller

Galaxy Millennium II is our flagship controller designed to meet the needs of the most advanced power systems. Building on the Galaxy Millennium platform, the Galaxy Millennium II delivers state-of-the-art performance by combining sophisticated control, monitoring, and remote network access previously on three separate circuit packs into a single integrated unit. The controller has been designed to simplify plant administrative and surveillance routines as well as reduce operating, provisioning, and personnel expenses. Configuration of the Galaxy Millennium II can be performed via menu based front panel display, a local terminal or remote modem using EasyView2, or through a local or remote network connection utilizing standard web browsers or network protocols. In addition to its standard integrated monitoring capabilities, this controller offers extensive external monitoring using bay interface cards (BICs), distribution control cards, and remote peripheral monitoring modules (RPMs) designed for various inputs and transducers. Additional external relay contacts are also available. The Galaxy Millennium II, with integrated network access, allows for advanced network supervision using standard network management protocols and available network management software. The ABB Galaxy Manager network management software can be used to meet power system engineering, operations and maintenance needs. Via the World Wide Web, users gain access to live data and information logged into Galaxy Manager's centralized server from each monitored system controller across the power network.

Key Features

- Integrated 10/100Base-T Ethernet Network capability
 - TCP/IP (IPv6 and IPv4 compatible)
 - SNMP (V3, V2c, V1) for management - SMTP for email
 - Telnet/SSH for command line interface
 - TL-1
 - DHCP for network plug-n-play
 - FTP/SFTP for rapid backup and upgrades
 - HTTP/HTTPs for standard web pages and browsers
 - Compatible with Galaxy Manager and other standard network management packages
 - Standard shielded RJ-45 interface referenced to chassis ground
- MODBUS Communications Protocol
- Optional Data switch
 - Connections to 3 standard RS-232 devices for pass-through and alarm management
 - BSN extension to provide 3 additional
- Configurable RS-232/485 port for remote via TL1/X.25
- Multiple password-protected security levels



Standard System Features

- Monitoring and control of many serial connected devices
 - Maximum of 40 serial switch mode rectifiers per bay for GPS4830 family
 - Maximum of 8 cabinet bays when configured using bay interface cards (BICs)
- Standard and custom User Defined system alarms
 - Alarm cut-off
 - Alarm test
 - Multiple-level alarm severity: Critical, Major, Minor, Warning, and record-only
- Standard rectifier management features
 - Automatic rectifier restart
 - Reserve engine transfer
 - Adaptive Rectifier Management (ARM)/Energy Efficiency
 - Remote rectifier (on/off) control
 - Automatic rectifier sequence control
 - N + X redundancy check
- Low Voltage Load and Low Voltage Battery Disconnect Options (3)
- Various levels of configuration, statistics, and history
 - All stored in non-volatile memory
 - Remote and local backup and restore of configuration data
- Remote and local software upgrade
- Basic, busy hour, and trend statistics kept
- Detailed history kept
- Maintenance reminders
- Inventory management
- User defined events and derived channels
- Hardware DIP switch access control

Standard Battery Management Features

- Float/boost mode control
 - Manual front panel boost
 - Manual timed boost locally, T1.317, and remotely initiated
 - External timed boost
 - Battery thermal protect module (BTP)
 - Auto boost terminated by time or current
- Battery discharge testing
 - Manual
 - Periodic
 - Plant Battery Test (PBT) in put driven
- Slope thermal compensation
 - High temperature compensation
 - Low temperature compensation
 - Step temperature
 - STC Enable/Disable, low temperature Enable/Disable
 - mV/°C adjustments
- High temperature disconnect/ step setting
- Sophisticated reserve-time prediction
 - User configurable system reserve low alarm during normal operation
 - User configurable reserve time low alarm
- Recharge current limit
- Integrated “At Rate Calculator” for estimation purposes
- Battery discharge trace data
- Emergency Power-Off Input
- Lithium battery fail input

Features

Integrated Outputs

- Traditional office alarm interface with 19 Form-C alarm outputs (60 VDC @ 0.3A)
 - Standard default assignments: Power Critical-Audio, Power Critical-Visual, Power Critical- External, Power Major-Audio, Power Major-Visual, Power Major-External, Power Minor- Audio, Power Minor- Visual, Power Minor-External, Major Fuse (MJF), Minor Fuse (MNF), Battery On Discharge (BD), AC Fail (ACF), Rectifier Fail, High Voltage (HV), Very Low Voltage (VLV), Controller Fail, User Relay 1, User Relay 2
- 16 Form-Cs are user assignable
- 1 1/3A Auxiliary Battery Supply (ABS) Output

Remote Peripheral Monitoring & Control

- Modular monitor and control growth options for up to 95 monitoring modules optimized for DC voltage and shunt monitoring, binary input detection, temperature monitoring, external transducer monitoring
- Additional Form-C relay output control available
- Devices managed and powered by the controller via one twisted-pair cable over distances of 300m or more
- Daisy-chain connections from module to module reduce installation costs and cable congestion
- Modules can be located near monitored source
- Various panels for rack- mounting available

Enhanced Battery Management Features

- Battery discharge test options including periodic and manual tests (local/ remote) with configurable thresholds or 20% discharge algorithm
- State of charge indication

- Rectifiers on-line during test (minimize risk to service)
- Discharge data stored in non-volatile memory. Graphical data available
- Accurate battery reserve time calculations that factor in battery specific parameters, plant voltage, load, temperature, number of battery strings and number of cells per string
- Thermal compensation (STC) and recharge current limit to maximize battery life

Extensive Plant and Monitoring Statistics

- Real-time data and historical statistics help analyze critical performance parameters
- Statistics for planning preventive or corrective maintenance before serious problems occur

Derived Channels

- 32 derived channels enable arithmetic and Boolean operations to be performed on measured values to allow customer specific parameters such as output power to be calculated and managed

Rectifier Management

- Energy efficiency, provides ability to automatically shutdown selected rectifiers during low plant loads maintaining maximum battery plant efficiency without sacrificing reliability
- Provides Reserve Operation feature for maintaining designated number of rectifiers “ON” during engine runs as well as proper sequencing for generators
- Provides ability to transfer rectifiers (TR1-TR4) to “ON” for certain sequences of return AC

Galaxy Manager Compatible

- Centralized web server and database with multiple user access to live or managed data with drill down to problem details
- Monitor and control of more than 40 connected devices

Features (Continued)

- On-screen visibility of information management from polling or alarms received from alarm traps from multiple sites via network connection.
- Trend user selected data over time
- Automatic or manual report generation
- Standard engineering tools like reserve time calculators and cable voltage drop analyzer

Specifications

General

Operating Voltage	± 24 VDC, ± 48 VDC (Range: ± 18 to ± 60 VDC)
Input Power	36 W (depending on options)
Operating Temperature Range	-40°C to +75°C (-40 to 167°F)
Storage Temperature Range	-40°C to +85°C (-40 to 185°F)
Operating Relative Humidity	0 - 95% (non-condensing)
Physical Specifications	9.24" H x 20.76" W x 2.14" D
Display	8-line by 40-character backlit LCD

Safety and Standards Compliance

NEBs	Evaluated by independent NRTL test lab to Telcordia GR63-CORE and GR1089-CORE Issue 6 [Level 3]
Safety	ANSI/UL62368-1-2014 and CAN/CSA C22.2 No. 62368-1-07, Second Edition + A2:2014 (MOD), dated October 14, 2014
RoHS	Compliant to RoHS EU Directive 2002/95/EC RoHS 6/6
EMC	European Directive 2014/30/EU; EN55032, Class B, EN55035; FCC, Class B; GR1089-CORE

Agency Certifications

NEBs	Evaluated by independent NRTL test lab to Telcordia GR63, Issue 3 and GR1089-CORE, Issue 6 (including level 3 testing)
EMC (Emissions)	European Directive 2014/30/EU; EN55032, (CISPR32) Class B, EN55035 (CISPR24)
Safety	Underwriters Laboratories (UL) Listed per Subject Letter 1801: Power Distribution Center for (CSA 22.2 950): Safety of Information Technology Equipment

Galaxy Pulsar Plus Controller

The Pulsar Plus family of controllers provides system monitoring and control features for GPS power systems. This controller monitors and controls system components including rectifiers, and distribution modules via a multi-drop RS485 digital communications bus. System status, parameters, settings, and alarm thresholds can be viewed and configured from the controller's front panel display. Assignment and configuration of alarm inputs and output relays can be performed from a laptop computer connected to a local RS-232, by Ethernet port connection, or by remote access through a network connection. An optional modem is also available.

This controller utilizes standard network management protocols allowing for advanced network supervision. ABB Galaxy Manager™ software is the centralized visibility and control component of a comprehensive power management system designed to meet engineering, operations and maintenance needs. The Galaxy Manager client-server architecture enables remote access to system controllers across the power network.

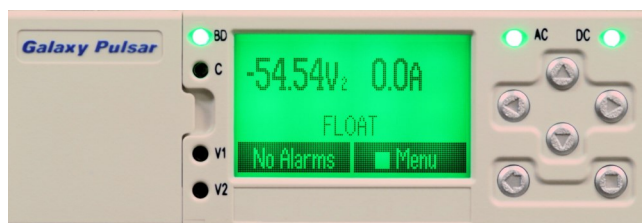

Key Features

Remote Access and Features

- Integrated 10/100 Base-T Ethernet Network
 - TCP/IP (IPv6 and IPv4 compatible)
 - SNMP (V3, V2c, V1) for management
 - SMTP for email
 - Telnet/SSH for command line interface
 - DHCP for plug-n-play
 - FTP/SFTP for rapid backup and upgrades
 - HTTP/HTTPS for standard web pages and browsers
 - NTP for clock synchronization
 - Compatible with Galaxy Manager and other management packages
 - Shielded RJ-45 interface referenced to chassis ground
- Password protected security levels: User, Super-User, Administrator for all access
- Ground-referenced RS232 system port
- ANSI T1.317 command-line interface
- Modem access support
 - Remote via external modem
 - Callback security
- EasyView2, Windows - based GUI software for local terminal or Modem access
- Optional 1U Display with context alarm indicating backlight feature

Key Features (Continued)

- Supporting the following Protocols:
 - SNMP V3
 - SSL
 - SSH
- ECO Priority controls and features
 - Advanced generator controls to help minimize fuel consumption for off grid applications
 - ECO Energy Management allowing for non-ECO sources outputs to be minimized while ECO resources are available

- Source and load trend logging

Standard System Features

- Monitor and control of more than 60 connected devices
 - Robust RS485 system bus
- Standard and user defined alarms
 - Alarm test
 - Assignable alarm severity: Critical, Major, Minor, Warning, Record-only
 - 10 alarm relays (7 user assigned)
- Rectifier management features
 - Automatic rectifier restart
 - Active Rectifier Management
 - ARM (energy efficiency)
 - Remote rectifier (on/off)
 - Reserve Operation
 - Automatic rectifier sequence control
 - N + X redundancy check
- Multiple Low Voltage Load and Low Voltage Battery Disconnect thresholds
- Configuration, statistics, and history
 - All stored in non-volatile memory
 - Remote/local backup and restore of configuration data

- Industry standard defaults
 - Customer specific configurations available
- Remote/ local software upgrade
- Basic, busy hour, and trend statistics
- Detailed event history
- User defined events and derived channels

Standard Battery Management Features

- Float/boost mode control
 - Manual boost
 - Manual timed boost locally, T1.317, and remotely initiated
 - Auto boost terminated by time or current
- Battery discharge testing
 - Manual (local/remote)
 - Periodic
 - Plant Battery Test (PBT) input driven
 - Configurable threshold or 20% algorithm
 - Graphical discharge data
 - Rectifiers on-line during test
- Slope thermal compensation
 - High temperature
 - Low temperature
 - Step temperature
 - STC Enable/Disable, low temperature Enable/Disable
 - Configurable mV/°C slopes
- State of charge indication
- High temperature disconnect setting
- Reserve-time prediction
- Recharge current limit
- Emergency Power-Off input

Integrated Monitoring Inputs/Outputs

- System plant voltage (accuracy $\pm 0.04V$, resolution $0.01V$)
- One system shunt (accuracy $\pm 0.5\%$ full scale, resolution $1A$)
 - Battery or load
 - Mounted in the return side of DC bus
- Up to 15 binary inputs
 - Six inputs close/open to battery
 - 9 input close/open to return
 - User assignable
- Up to 7 Form-C output alarms (60 VDC @ 0.5A)
 - User assignable
- 1-Wire™ bus devices
 - Up to 16 temperature probes (QS873)
 - Up to 6 mid-string monitors (ES771)

Galaxy Manager Compatible

- Centralized web server and database with multiple user access to live or managed data with drill down to problem details
- Monitor and control of more than 40 connected devices
- Management information from polling or alarms received from alarm traps from multiple sites are available on one screen via the inter/intranet
- Trend user selected data over time
- Automatic or manual report generation
- Standard engineering tools like reserve time calculators and cable voltage drop analyzer

Specifications

General

Operating Voltage	± 24 VDC, ± 48 VDC (Range: ± 18 to ± 60 VDC)
Input Power	Less than 7 W
Operating Temperature Range	-40°C to $+75^{\circ}\text{C}$ (-40°F to 167°F)
Operating Relative Humidity	0 - 95% (non-condensing)
Storage Temperature Range	-40°C to $+85^{\circ}\text{C}$ (-40°F to 185°F)
Physical Specifications	Sizes vary by packaging option
Display	8-line by 40-character with alarm context sensitive backlit LCD

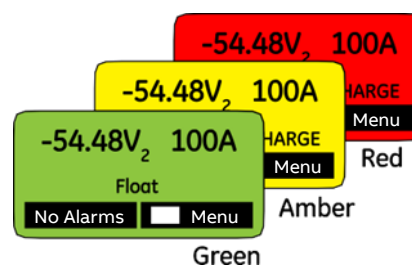

Safety And Standards Compliance

NEBs	Evaluated by independent NRTL test lab to Telcordia GR63-CORE and GR1089-CORE Issue 6 [Level 3]
Safety	ANSI/UL62368-1-2014 and CAN/CSA C22.2 No. 62368-1-07, Second Edition + A2:2014 (MOD), dated October 14, 2014
RoHS	Compliant to RoHS EU Directive 2002/95/EC RoHS 6/6
EMC	European Directive 2014/30/EU; EN55032, Class A, EN55035; FCC, Class A; GR1089-CORE

Agency Certifications

NEBs Level 3	Evaluated by independent NRTL test lab to Telcordia GR63-CORE and GR1089-CORE Issue 6 [Level 3]
EMC	European Directive 2014/30/EU; EN55032, (CISPR32) Class B, EN55035 (CISPR24)
Safety	Underwriters Laboratories (UL) Listed per Subject Letter 1801: Power Distribution Center for Communications Equipment, and cUL Certified (CSA 22.2950): Safety of Information Technology Equipment

*Note that the Pulsar Controller is for single bay systems only where there are no disconnects

Ordering Information – GPS4830 Power System

The 4830 system can be deployed with capacity of up to 2,760 amps in a single cabinet, or expanded over multiple cabinets. Designed for either internal input AC breakers or terminal strip terminations, rectifier shelves can be spread across multiple bays to maximize distribution availability and provide modular growth. In applications needing additional distribution, two or more bays can be added and dedicated exclusively for distribution. For greater flexibility and working space, the 4830 may be equipped with a larger 36 inch wide distribution bay to accommodate large cable termination and egress.

Key Features

- AC input applications utilizing 3 Φ 480Y VAC or 3 Φ 208 VAC
- Full featured control and monitoring capability with the flagship Galaxy Millennium II or Pulsar Plus controller
- Up to 72 rectifiers and other digitally connected peripherals
- Single Bay, 12 shelf configuration with up to 2,760A of rectification and 44” of available distribution space
- TE rectifier efficiency

Additional Information

This ordering guide represents the most common configurations available for the GPS4830 product family. However due to the high number of combinations available within the product line, and changing availability of product parts, not all combinations and/or parts are represented herein. For a complete set of all combinations and latest updates see the GPS Ordering Guide Detailed Drawing as noted below. Other reference documents provide additional detail beyond this guide.







REFERENCE DOCUMENT	TITLE
H5694827_4830_434-DS	GPS Ordering Guide Detailed Drawing
108327362	GPS Installation Guide
108994645	Millennium II Controller Product Manual
107570517	Galaxy Remote Peripheral Monitoring System Product Manual (167790063)
CC848815341	Pulsar Plus Controller Family Product Manual

Step 1A: Select Power Bays [GP100H3 versions] (Consult ABB Solutions Engineers)

-48V Primary (Control) Bays with Millennium Controller

OUTPUT	ORDERING CODE	ORDERING DESCRIPTION
 -48V Distributed 880A	150051762	GPS4830 Distributed Architecture Full Height Control Bay with <ul style="list-style-type: none"> • Millennium 2 controller • Terminal strip 480 VAC feed input for (8) GP100 rectifier positions, (1) feed per (2) rectifiers • 1500 amp battery shunt • 60" space available for distribution H5694830 G001 G019 G304A G032
 -48V Distributed 880A	150051763	GPS4830 Distributed Architecture Full Height Control Bay with <ul style="list-style-type: none"> • Millennium 2 controller • Terminal strip 480 VAC feed input for (8) GP100 rectifier positions, (1) feed per (4) rectifiers • 1500 amp battery shunt • 60" space available for distribution H5694830 G001 G019 G304B G032
 -48V Distributed 1,320A	150051764	GPS4830 Distributed Architecture Full Height Control Bay with <ul style="list-style-type: none"> • Millennium 2 controller • Terminal strip 480 VAC feed input for (12) GP100 rectifier positions, (1) feed per (2) rectifiers • 1500 amp battery shunt • 56" space available for distribution H5694830 G001 G019 G306A G032
 -48V Distributed 1,320A	150051765	GPS4830 Distributed Architecture Full Height Control Bay with <ul style="list-style-type: none"> • Millennium 2 controller • Terminal strip 480 VAC feed input for (12) GP100 rectifier positions, (1) feed per (4) rectifiers • 1500 amp battery shunt • 56" space available for distribution H5694830 G001 G019 G306B G032
 -48V Distributed 1,760A	1600398829A	GPS4830 Distributed Architecture Full Height Control Bay with <ul style="list-style-type: none"> • Millennium 2 controller • Terminal strip 480 VAC feed input for (16) GP100 rectifier positions, (1) feed per (2) rectifiers • 6000 amp battery shunt • 52" space available for distribution H5694830 G001 G019 G308A G032B
 -48V Distributed 1,760A	1600398830A	GPS4830 Distributed Architecture Full Height Control Bay with <ul style="list-style-type: none"> • Millennium 2 controller • Terminal strip 480 VAC feed input for (16) GP100 rectifier positions, (1) feed per (4) rectifiers • 6000 amp battery shunt • 52" space available for distribution H5694830 G001 G019 G308B G032B
 -48V Distributed 2,220A	1600398837A	GPS4830 Distributed Architecture Full Height Control Bay with <ul style="list-style-type: none"> • Millennium 2 controller • Terminal strip 480 VAC feed input for (20) GP100 rectifier positions, (1) feed per (2) rectifiers • 6000 amp battery shunt • 48" space available for distribution H5694830 G001 G019 G310A G032B
 -48V Distributed 2,200A	1600398839A	GPS4830 Distributed Architecture Full Height Control Bay with <ul style="list-style-type: none"> • Millennium 2 controller • Terminal strip 480 VAC feed input for (20) GP100 rectifier positions, (1) feed per (4) rectifiers • 6000 amp battery shunt • 48" space available for distribution H5694830 G001 G019 G310B G032B





-48V Primary (Control) Bays with Millennium Controller [GP100H3 Continued]

OUTPUT	ORDERING CODE	ORDERING DESCRIPTION
 -48V Distributed 2,400A	1600398846A	GPS4830 Distributed Architecture Full Height Control Bay with <ul style="list-style-type: none"> • Millennium 2 controller • Terminal strip 480VAC feed input for (24) GP100 rectifier positions, (1) feed per (2) rectifiers • 6000 amp battery shunt • 44" Distribution space H5694830 G001 G019 G312A G032B
 -48V Distributed 2,400A	1600398844A	GPS4830 Distributed Architecture Full Height Control Bay with <ul style="list-style-type: none"> • Millennium 2 controller • Terminal strip 480VAC feed input for (24) GP100 rectifier positions, (1) feed per (4) rectifiers • 6000 amp battery shunt • 44" space available for distribution H5694830 G001 G019 G312B G032B
 -48V Distributed 880A	150051725	GPS4830 Distributed Architecture Full Height Control Bay with <ul style="list-style-type: none"> • Millennium 2 controller • Internal 480 VAC Circuit breaker panel rectifier input for (8) GP100 rectifier position, (1) external feed to (4) circuit breakers • 3000 amp battery shunt • 62" space available for distribution H5694830 G001 G019 G334A G032A
 -48V Distributed 1,760A	1600398825A	GPS4830 Distributed Architecture Full Height Control Bay with <ul style="list-style-type: none"> • Millennium 2 controller • Internal 480 VAC Circuit breaker panel rectifier input for (16) GP100 rectifier positions, (1) external feed to (4) circuit breakers • 6000 amp battery shunt • 54" space available for distribution H5694830 G001 G019 G334B G032B
 -48V Distributed 1,320A	150051727	GPS4830 Distributed Architecture Full Height Control Bay with <ul style="list-style-type: none"> • Millennium 2 controller • Internal 480 VAC Circuit breaker panel rectifier input for (12) GP100 rectifier positions, (2) feeds to (6) circuit breakers • 3000 amp battery shunt • 55" space available for distribution H5694830 G001 G019 G346A G032A
 -48V Distributed 2,760 A	1600398827A	GPS4830 Distributed Architecture Full Height Control Bay with <ul style="list-style-type: none"> • Millennium 2 controller • Internal 480 VAC Circuit breaker panel rectifier input for (24) GP100 rectifier positions, (2) feeds to (6) circuit breakers • 6000 amp battery shunt • 43" space available for distribution H5694830 G001 G019 G346B G032B

-48V Supplemental Bays to be Used With Previous Initial Bays [GP100H3 versions]

OUTPUT	ORDERING CODE	ORDERING DESCRIPTION
 -48V Distributed 880A	150051793	GPS4830 Distributed Architecture Full Height Supplemental Bay with <ul style="list-style-type: none"> No controller Terminal strip 480 VAC feed input for (8) GP100 rectifier positions, (1) feed per (2) rectifiers 1500 amp battery shunt 60" space available for distribution H5694830 G001 G018D G304A G032
 -48V Distributed 880A	150051794	GPS4830 Distributed Architecture Full Height Supplemental Bay with <ul style="list-style-type: none"> No controller Terminal strip 480 VAC feed input for (8) GP100 rectifier positions, (1) feed per (4) rectifiers 1500 amp battery shunt 60" space available for distribution H5694830 G001 G018D G304B G032
 -48V Distributed 1,320A	150051795	GPS4830 Distributed Architecture Full Height Supplemental Bay with <ul style="list-style-type: none"> No controller Terminal strip 480 VAC feed input for (12) GP100 rectifier positions, (1) feed per (2) rectifiers 1500 amp battery shunt 56" space available for distribution H5694830 G001 G018D G306A G032
 -48V Distributed 1,320A	150051796	GPS4830 Distributed Architecture Full Height Supplemental Bay with <ul style="list-style-type: none"> No controller Terminal strip 480 VAC feed input for (12) GP100 rectifier positions, (1) feed per (4) rectifiers 1500 amp battery shunt 56" space available for distribution H5694830 G001 G018D G306B G032
 -48V Distributed 1,760A	1600398834A	GPS4830 Distributed Architecture Full Height Supplemental Bay with <ul style="list-style-type: none"> No controller Terminal strip 480 VAC feed input for (16) GP100 rectifier positions, (1) feed per (2) rectifiers 6000 amp battery shunt 52" space available for distribution H5694830 G001 G018D G308A G032B
 -48V Distributed 1,760A	1600398831A	GPS4830 Distributed Architecture Full Height Supplemental Bay with <ul style="list-style-type: none"> No controller Terminal strip 480 VAC feed input for (16) GP100 rectifier positions, (1) feed per (4) rectifiers 6000 amp battery shunt 52" space available for distribution H5694830 G001 G018D G308B G032B
 -48V Distributed 2,200A	1600398838A	GPS4830 Distributed Architecture Full Height Supplemental Bay with <ul style="list-style-type: none"> No controller Terminal strip 480 VAC feed input for (20) GP100 rectifier positions, (1) feed per (2) rectifiers 6000 amp battery shunt 48" space available for distribution H5694830 G001 G018D G310A G032B
 -48V Distributed 2,200A	1600398840A	GPS4830 Distributed Architecture Full Height Supplemental Bay with <ul style="list-style-type: none"> No controller Terminal strip 480 VAC feed input for (20) GP100 rectifier positions, (1) feed per (4) rectifiers 6000 amp battery shunt 48" space available for distribution H5694830 G001 G018D G310B G032B
 -48V Distributed 2,400A	1600398843A	GPS4830 Distributed Architecture Full Height Supplemental Bay with <ul style="list-style-type: none"> No controller Terminal strip 480 VAC feed input for (24) GP100 rectifier positions, (1) feed per (2) rectifiers 6000 amp battery shunt 44" Distribution space H5694830 G001 G018D G312A G032B

-48V Supplemental Bays to be Used With Previous Initial Bays [GP100H3 Cont.]

OUTPUT	ORDERING CODE	ORDERING DESCRIPTION
 -48V Distributed 2,400A	1600398842A	GPS4830 Distributed Architecture Full Height Supplemental Bay with <ul style="list-style-type: none"> No controller Terminal strip 480VAC feed input for (24) GP100 rectifier positions, (1) feed per (4) rectifiers 6000 amp battery shunt 44" space available for distribution H5694830 G001 G018D G312B G032B
 -48V Distributed 880A	150051803	GPS4830 Distributed Architecture Full Height Supplemental Bay with <ul style="list-style-type: none"> No controller Internal 480 VAC Circuit breaker panel rectifier input for (8) GP100 rectifier positions, (1) feed to (4) circuit breakers 3000 amp battery shunt 62" space available for distribution H5694830 G001 G018D G334A G032A
 -48V Distributed 1,760A	1600398826A	GPS4830 Distributed Architecture Full Height Supplemental Bay with <ul style="list-style-type: none"> No controller Internal 480 VAC Circuit breaker panel rectifier input for (16) rectifier positions, (1) feed to (4) circuit breakers 6000 amp battery shunt 54" space available for distribution H5694830 G001 G018D G334B G032B
 -48V Distributed 1,320A	150051805	GPS4830 Distributed Architecture Full Height Supplemental Bay with <ul style="list-style-type: none"> No controller Internal 480 VAC Circuit breaker panel rectifier input for (12) rectifier positions, (2) feeds to (6) circuit breakers 3000 amp battery shunt 55" space available for distribution H5694830 G001 G018D G346A G032A
 -48V Distributed 2,760A	1600398828A	GPS4830 Distributed Architecture Full Height Supplemental Bay with <ul style="list-style-type: none"> No controller Internal 480 VAC Circuit breaker panel rectifier input for (24) rectifier positions, (2) feeds to (6) circuit breakers 6000 amp battery shunt 43" space available for distribution H5694830 G001 G018D G346B G032B

-48V Bays with Pulsar Plus Controllers (Single Bay Systems Only) [GP100H3]

OUTPUT	ORDERING CODE	ORDERING DESCRIPTION
 48V Distributed 880A	150051768	GPS4830 Distributed Architecture Full Height Control Bay with <ul style="list-style-type: none"> • Pulsar Plus controller • Terminal strip 480 VAC feed input for (8) GP100 rectifier positions, (1) feed per (2) rectifiers • 1500 amp battery shunt • 60" space available for distribution H5694830 G001 G020 G304A G032
 -48V Distributed 880A	150051769	GPS4830 Distributed Architecture Full Height Control Bay with <ul style="list-style-type: none"> • Pulsar Plus controller • Terminal strip 480 VAC feed input for (8) GP100 rectifier positions, (1) feed per (4) rectifiers • 1500 amp battery shunt • 60" space available for distribution H5694830 G001 G020 G304B G032
 -48V Distributed 1,320A	150051770	GPS4830 Distributed Architecture Full Height Control Bay with <ul style="list-style-type: none"> • Pulsar Plus controller • Terminal strip 480 VAC feed input for (12) GP100 rectifier positions, (1) feed per (2) rectifiers • 1500 amp battery shunt • 56" space available for distribution H5694830 G001 G020 G306A G032
 -48V Distributed 1,320A	150051771	GPS4830 Distributed Architecture Full Height Control Bay with <ul style="list-style-type: none"> • Pulsar Plus controller • Terminal strip 480 VAC feed input for (12) GP100 rectifier positions, (1) feed per (4) rectifiers • 1500 amp battery shunt • 56" space available for distribution H5694830 G001 G020 G306B G032
 -48V Distributed 1,760A	1600398855A	GPS4830 Distributed Architecture Full Height Control Bay with <ul style="list-style-type: none"> • Pulsar Plus controller • Terminal strip 480 VAC feed input for (16) GP100 rectifier positions, (1) feed per (2) rectifiers • 6000 amp battery shunt • 52" space available for distribution H5694830 G001 G020 G308A G032B
 48V Distributed 1,760A	1600398856A	GPS4830 Distributed Architecture Full Height Control Bay with <ul style="list-style-type: none"> • Pulsar Plus controller • Terminal strip 480 VAC feed input for (16) GP100 rectifier positions, (1) feed per (4) rectifiers • 6000 amp battery shunt • 52" space available for distribution H5694830 G001 G020 G308B G032B
 -48V Distributed 2,200A	1600398859A	GPS4830 Distributed Architecture Full Height Control Bay with <ul style="list-style-type: none"> • Pulsar Plus controller • Terminal strip 480 VAC feed input for (20) GP100 rectifier positions, (1) feed per (2) rectifiers • 6000 amp battery shunt • 48" space available for distribution H5694830 G001 G020 G310A G032B
 -48V Distributed 2,200A	1600398857A	GPS4830 Distributed Architecture Full Height Control Bay with <ul style="list-style-type: none"> • Pulsar Plus controller • Terminal strip 480 VAC feed input for (20) GP100 rectifier positions, (1) feed per (4) rectifiers • 6000 amp battery shunt • 48" space available for distribution H5694830 G001 G020 G310B G032B
 -48V Distributed 2,400A	1600398858A	GPS4830 Distributed Architecture Full Height Control Bay with <ul style="list-style-type: none"> • Pulsar Plus controller • Terminal strip 480 VAC feed input for (24) GP100 rectifier positions, (1) feed per (2) rectifiers • 6000 amp battery shunt • 44" Distribution space H5694830 G001 G020 G312B G032B

-48V Bays with Pulsar Plus Controllers (Single Bay Systems Only) [GP100H3 Cont.]

OUTPUT	ORDERING CODE	ORDERING DESCRIPTION
 -48V Distributed 2,400A	1600398860A	GPS4830 Distributed Architecture Full Height Control Bay with <ul style="list-style-type: none"> Pulsar Plus controller Terminal strip 480 VAC feed input for (24) GP100 rectifier positions, (1) feed per (4) rectifiers 6000 amp battery shunt 44" space available for distribution H5694830 G001 G020 G312B G032B
 -48V Hybrid Distributed 2,640A	1600398853A	GPS4830 Distributed Architecture Full Height Control Bay with Top AC in/ Bottom DC out <ul style="list-style-type: none"> Pulsar Plus controller Terminal strip 480 VAC feed input for (24) GP100 rectifier positions, (1) feed per (4) rectifiers 6000 amp battery shunt 40" space available for distribution H5694830 G001 G020 G634 G032B
 -48V Hybrid Distributed 2,640A	1600398854A	GPS4830 Distributed Architecture Full Height Control Bay with Top AC in/ Bottom DC out <ul style="list-style-type: none"> Pulsar Plus controller Internal 480 VAC Circuit breaker panel rectifier input for (24) GP100 rectifier positions, (2) feeds to (6) circuit breakers 6000 amp battery shunt 39" space available for distribution H5694830 G001 G020 G646B G032B
 -48V Distributed 880A	150051785	GPS4830 Distributed Architecture Full Height Control Bay with <ul style="list-style-type: none"> Pulsar Plus controller Internal 480 VAC Circuit breaker panel rectifier input for (8) GP100 rectifier positions, (1) feed to (4) circuit breakers 3000 amp battery shunt 62" space available for distribution H5694830 G001 G020 G334A G032A
 -48V Distributed 1,760A	1600398861A	GPS4830 Distributed Architecture Full Height Control Bay with <ul style="list-style-type: none"> Pulsar Plus controller Internal 480 VAC Circuit breaker panel rectifier input for (16) GP100 rectifier positions, (1) feed to (4) circuit breakers 6000 amp battery shunt 54" space available for distribution H5694830 G001 G020 G334B G032B
 -48V Distributed 1,320A	150051787	GPS4830 Distributed Architecture Full Height Control Bay with <ul style="list-style-type: none"> Pulsar Plus controller Internal 480 VAC Circuit breaker panel rectifier input to (12) GP100 rectifier positions, (2) feeds to (6) circuit breakers 3000 amp battery shunt 55" space available for distribution H5694830 G001 G020 G346A G032A
 -48V Distributed 2,760A	1600398862A	GPS4830 Distributed Architecture Full Height Control Bay with <ul style="list-style-type: none"> Pulsar Plus controller Internal 480 VAC Circuit breaker panel rectifier input to (24) GP100 rectifier positions, (2) feeds to (6) circuit breakers 6000 amp battery shunt 43" space available for distribution H5694830 G001 G020 G346B G032B

Step 1B: Select Power Bays [GP100L3 versions] (Consult ABB Solutions Engineers)





-48V Primary (Control) Bays with Millennium Controller

OUTPUT	ORDERING CODE	ORDERING DESCRIPTION
 -48V Distributed 880A	1600398799A	GPS4830 Distributed Architecture Full Height Control Bay with <ul style="list-style-type: none"> • Millennium 2 controller • Terminal strip 208 VAC feed input for (8) GP100 rectifier positions, (1) feed per (2) rectifiers • 3000 amp battery shunt • 60" space available for distribution H5694830 G001 G019 G364A G032A
 -48V Distributed 880A	1600398806A	GPS4830 Distributed Architecture Full Height Control Bay with <ul style="list-style-type: none"> • Millennium 2 controller • Terminal strip 208 VAC feed input for (8) GP100 rectifier positions, (1) feed per (1) rectifiers • 3000 amp battery shunt • 60" space available for distribution H5694830 G001 G019 G364C G032A
 -48V Distributed 1,320A	1600398801A	GPS4830 Distributed Architecture Full Height Control Bay with <ul style="list-style-type: none"> • Millennium 2 controller • Terminal strip 208 VAC feed input for (12) GP100 rectifier positions, (1) feed per (2) rectifiers • 3000 amp battery shunt • 56" space available for distribution H5694830 G001 G019 G366A G032A
 -48V Distributed 1,320A	1600398811A	GPS4830 Distributed Architecture Full Height Control Bay with <ul style="list-style-type: none"> • Millennium 2 controller • Terminal strip 208 VAC feed input for (12) GP100 rectifier positions, (1) feed per (1) rectifiers • 3000 amp battery shunt • 56" space available for distribution H5694830 G001 G019 G366C G032A
 -48V Distributed 1,760A	1600398803A	GPS4830 Distributed Architecture Full Height Control Bay with <ul style="list-style-type: none"> • Millennium 2 controller • Terminal strip 208 VAC feed input for (16) GP100 rectifier positions, (1) feed per (2) rectifiers • 6000 amp battery shunt • 52" space available for distribution H5694830 G001 G019 G368A G032B
 -48V Distributed 1,760A	1600398813A	GPS4830 Distributed Architecture Full Height Control Bay with <ul style="list-style-type: none"> • Millennium 2 controller • Terminal strip 208 VAC feed input for (16) GP100 rectifier positions, (1) feed per (1) rectifiers • 6000 amp battery shunt • 52" space available for distribution H5694830 G001 G019 G368C G032B
 -48V Distributed 2,200A	1600398804A	GPS4830 Distributed Architecture Full Height Control Bay with <ul style="list-style-type: none"> • Millennium 2 controller • Terminal strip 208 VAC feed input for (20) GP100 rectifier positions, (1) feed per (2) rectifiers • 6000 amp battery shunt • 48" space available for distribution H5694830 G001 G019 G370A G032B
 -48V Distributed 2,200A	1600398809A	GPS4830 Distributed Architecture Full Height Control Bay with <ul style="list-style-type: none"> • Millennium 2 controller • Terminal strip 208 VAC feed input for (20) GP100 rectifier positions, (1) feed per (1) rectifiers • 6000 amp battery shunt • 48" space available for distribution H5694830 G001 G019 G370C G032B



Step 1B: Select Power Bays [GP100L3 Continued]

(Consult ABB Solutions Engineers)

-48V Primary (Control) Bays with Millennium Controller



OUTPUT	ORDERING CODE	ORDERING DESCRIPTION
 -48V Distributed 2,760A	1600376026A	GPS4830 Distributed Architecture Full Height Control Bay with <ul style="list-style-type: none"> • Millennium 2 controller • Terminal strip 208 VAC feed input for (24) GP100 rectifier positions, (1) feed per (2) rectifiers • 6000 amp battery shunt • 44" space available for distribution H5694830 G001 G019 G372A G032B
 -48V Distributed 2,760A	1600398815A	GPS4830 Distributed Architecture Full Height Control Bay with <ul style="list-style-type: none"> • Millennium 2 controller • Terminal strip 208 VAC feed input for (24) GP100 rectifier positions, (1) feed per (1) rectifiers • 6000 amp battery shunt • 44" space available for distribution H5694830 G001 G019 G372C G032B
 -48V Distributed 880A	1600398792A	GPS4830 Distributed Architecture Full Height Control Bay with <ul style="list-style-type: none"> • Millennium 2 controller • Internal 208 VAC Circuit breaker panel rectifier input for (8) GP100 rectifier position, (1) external feed to (4) 50A circuit breakers • 3000 amp battery shunt • 62" space available for distribution H5694830 G001 G019 G384A G032A
 -48V Distributed 1,320A	1600398794A	GPS4830 Distributed Architecture Full Height Control Bay with <ul style="list-style-type: none"> • Millennium 2 controller • Internal 208 VAC Circuit breaker panel rectifier input for (12) GP100 rectifier position, (2) external feed to (6) 50A circuit breakers • 3000 amp battery shunt • 55" space available for distribution H5694830 G001 G019 G386A G032A

-48V Primary (Control) Bays with Pulsar Controller



OUTPUT	ORDERING CODE	ORDERING DESCRIPTION
 -48V Distributed 880A	1600398817A	GPS4830 Distributed Architecture Full Height Control Bay with <ul style="list-style-type: none"> • Pulsar Plus controller • Terminal strip 208 VAC feed input for (8) GP100 rectifier positions, (1) feed per (2) rectifiers • 3000 amp battery shunt • 60" space available for distribution H5694830 G001 G020 G364A G032A
 -48V Distributed 1,320A	1600398818A	GPS4830 Distributed Architecture Full Height Control Bay with <ul style="list-style-type: none"> • Pulsar Plus controller • Terminal strip 208 VAC feed input for (12) GP100 rectifier positions, (1) feed per (2) rectifiers • 3000 amp battery shunt • 56" space available for distribution H5694830 G001 G020 G366A G032A
 -48V Distributed 1,760A	1600398819A	GPS4830 Distributed Architecture Full Height Control Bay with <ul style="list-style-type: none"> • Pulsar Plus controller • Terminal strip 208 VAC feed input for (16) GP100 rectifier positions, (1) feed per (2) rectifiers • 6000 amp battery shunt • 52" space available for distribution H5694830 G001 G020 G368A G032B

Step 1B: Select Power Bays [GP100L3 Continued] (Consult ABB Solutions Engineers)

-48V Primary (Control) Bays with Pulsar Controller





OUTPUT	ORDERING CODE	ORDERING DESCRIPTION
 -48V Distributed 2,200A	1600399004A	GPS4830 Distributed Architecture Full Height Control Bay with <ul style="list-style-type: none"> • Pulsar Plus controller • Terminal strip 208 VAC feed input for (20) GP100 rectifier positions, (1) feed per (2) rectifiers • 6000 amp battery shunt • 48" space available for distribution H5694830 G001 G020 G370A G032B
 -48V Distributed 2,760A	1600399005A	GPS4830 Distributed Architecture Full Height Control Bay with <ul style="list-style-type: none"> • Pulsar Plus controller • Terminal strip 208 VAC feed input for (24) GP100 rectifier positions, (1) feed per (2) rectifiers • 6000 amp battery shunt • 44" space available for distribution H5694830 G001 G020 G372A G032B
 -48V Distributed 880A	1600398820A	GPS4830 Distributed Architecture Full Height Control Bay with <ul style="list-style-type: none"> • Pulsar Plus controller • Internal 208 VAC Circuit breaker panel rectifier input for (8) GP100 rectifier position, (1) external feed to (4) 50A circuit breakers • 3000 amp battery shunt • 62" space available for distribution H5694830 G001 G020 G384A G032A

-48V Supplemental Bay to be Used With Previous Initial Bays [GP100L3 versions]

OUTPUT	ORDERING CODE	ORDERING DESCRIPTION
 -48V Distributed 880A	1600398793A	GPS4830 Distributed Architecture Full Height Supplemental Bay with <ul style="list-style-type: none"> • No controller • Internal 208 VAC Circuit breaker panel rectifier input for (8) GP100 rectifier positions, (1) feed to (4) circuit breakers • 3000 amp battery shunt • 62" space available for distribution H5694830G001G018DG384AG032A
 -48V Distributed 1320A	1600398795A	GPS4830 Distributed Architecture Full Height Supplemental Bay with <ul style="list-style-type: none"> • No controller • Internal 208 VAC Circuit breaker panel rectifier input for (12) GP100 rectifier positions, (2) feed to (6) circuit breakers • 3000 amp battery shunt • 55" space available for distribution H5694830G001G018DG386AG032A
 -48V Distributed 880A	1600398800A	GPS4830 Distributed Architecture Full Height Supplemental Bay with <ul style="list-style-type: none"> • No controller • Terminal strip 208 VAC feed input for (8) GP100 rectifier positions, (1) feed per (2) rectifiers • 3000 amp battery shunt • 60" space available for distribution H5694830G001G018DG364AG032A

Step 1B: Select Power Bays [GP100L3 Continued] (Consult ABB Solutions Engineers)





-48V Supplemental Bay to be Used With Previous Initial Bays [GP100L3 versions]

Output	Ordering code	Ordering description
 -48V Distributed 1320A	1600398802A	GPS4830 Distributed Architecture Full Height Supplemental Bay with <ul style="list-style-type: none"> No controller Terminal strip 208 VAC feed input for (12) GP100 rectifier positions, (1) feed per (2) rectifiers 3000 amp battery shunt 56" space available for distribution H5694830G001G018DG366AG032A
 -48V Distributed 1760A	1600398805A	GPS4830 Distributed Architecture Full Height Supplemental Bay with <ul style="list-style-type: none"> No controller Terminal strip 208 VAC feed input for (16) GP100 rectifier positions, (1) feed per (2) rectifiers 6000 amp battery shunt 52" space available for distribution H5694830G001G018DG368AG032B
 -48V Distributed 880A	1600398807A	GPS4830 Distributed Architecture Full Height Supplemental Bay with <ul style="list-style-type: none"> No controller Terminal strip 208 VAC feed input for (8) GP100 rectifier positions, (1) feed per (1) rectifiers 3000 amp battery shunt 60" space available for distribution H5694830G001G018DG364CG032A
 -48V Distributed 1320A	1600398812A	GPS4830 Distributed Architecture Full Height Supplemental Bay with <ul style="list-style-type: none"> No controller Terminal strip 208 VAC feed input for (12) GP100 rectifier positions, (1) feed per (1) rectifiers 3000 amp battery shunt 56" space available for distribution H5694830G001G018DG366CG032A
 -48V Distributed 1760A	1600398810A	GPS4830 Distributed Architecture Full Height Supplemental Bay with <ul style="list-style-type: none"> No controller Terminal strip 208 VAC feed input for (16) GP100 rectifier positions, (1) feed per (1) rectifiers 6000 amp battery shunt 52" space available for distribution H5694830G001G018DG368CG032B

-48V Distribution Bay Only

Output	Ordering code	Ordering description
 -48V Distribution Only 1200A	150051980	GPS4830 Distributed Architecture Full Height Distribution only bay with <ul style="list-style-type: none"> No controller No rectifier positions 72" space available for distribution panels H569434G1G18DG428G33

Step 2: Select Rectifier

OUTPUT	ORDERING CODE	MODEL	AC IN (TYP)	PHOTO
 115A	150034309	GP100H3R48TEZ	480	
 115A	150034310	GP100L3R48TEZ	208/240	

Step 3: Select Field Installed Distribution Panels

ORDERING CODE	GROUP CODE	PANEL DESCRIPTION (PANEL ONLY)	RETURN BUS (ORDER SEPARATE)	VERTICAL SPACE
108907791	43A	6 Position 125A-800A circuit breaker panel	108908070	12"
108907858	42A	3 Position 125A-600A circuit breaker panel	108908070	6"
108907973	48A	5 Position 125A-800A circuit breaker panel	108908070	9"
108966342	97A	14 Position 3A-200A bullet breaker panel	108908104	6"
108985847	98A	22 position 3A-200A bullet breaker panel	108908104	9"
108907841	68A	2 position 32A-400A NH2 DIN fuse panel	108908070	6"
108907874	67A	8 position 4A-160A NH00 DIN fuse panel	108908104	6"
108907999	52A	10 position 3A-60A TPS fuse panel	108908104	6"
108966359	54A	5 position 70A-225A TPL-B fuse panel	108908070	9"
CC109121472	59A	2 position 300-800A TPL-B,C fuse panel	108908070	6"
108985235	58A	6 position 1-7.5A GMT fuse panel	N/A	0"
108908278	ED83143-31 FA	Low voltage load disconnect option (order when needing LVLD to a distribution load panel)	N/A	

Step 4: Select Distribution Components



Note: Plug in, and bolt in distribution components are listed below.

These must be selected to match the distribution panels selected in Step 3.







Bullet Style Load Circuit Breakers

ORDERING CODE	AMPERAGE	CB POSITIONS (POLES)	MIN WIRE GAUGE	PHOTO
407998137	3	1	10	
407998145	5	1	10	
407998152	10	1	10	
407998160	15	1	10	
407998178	16	1	10	
407998186	20	1	10	
407998194	25	1	10	
407998202	30	1	10	
408213486	40	1	8	
407998210	45	1	8	
407998228	50	1	6	
407998236	60	1	6	
407998244	70	1	2	
407998251	80	1	2	
407998269	90	1	2	
407998277	100	1	2	
CC848808551	100	2	2	
408185353	125	2	2	
408185346	150	2	1/0	

Step 4: Select Distribution Components (Continued)

ORDERING CODE	AMPERAGE	CB POSITIONS (POLES)	MIN. WIRE GAUGE	PHOTO
408564941	200	3	2/0	
408535752	250	3	4/0	
848631479	2-pole adapter bus kit (includes bus for 1/4" hole lug on 5/8" centers and hardware), order two per breaker			
848745662	3-pole adapter bus kit (includes bus for 5/16" hole lug on 1" centers and hardware), order two per breaker			

Large Circuit Breaker Kits

ORDERING CODE	AMPERAGE	CB POSITIONS (POLES)	MIN. WIRE GAUGE	PHOTO
108908187	125	1	2	
108908179	150	1	1/0	
108908195	175	1	1/0	
108908203	225	1	4/0	
108908211	300	2	2 x 4/0	
108908237	400	2	2 x 4/0	
108908229	500	3	3 x 4/0	
108908252	600	3	3 x 4/0	
108984782	800	4	4 x 4/0	
				

Step 4: Select Distribution Components (Continued)

Large TPL Fuses

ORDERING CODE	AMERAGE	MAX # WIRES PER POSITION	MIN WIRE GAUGE	PHOTO
408472322	70-250A fuse head holder option for use with 300-800 fuse head (only required for 2 Position 70A-600A TPL Fuse Panel)			
402328926	0.18A Alarm Fuse			
406794776	70	2	6	
408239648	80	2	4	
406794784	100	2	2	
406925685	125	2	2	
406794792	150	2	1/0	
406794818	200	2	4/0	
406794982	225	2	4/0	
406794842	250	2	4/0	
406794867	300	2	2 x 4/0	
406794875	400	2	2 x 4/0	
406794883	500	2	2 x 4/0	
406794891	600	2	2 x 350 kcmil flex	

Bullet Style Fuse Holder and TPS Fuses

ORDERING CODE	AMERAGE	WP-92461 LIST	MIN WIRE GAUGE	PHOTO
406700567	3	100	10	
406700583	5	101	10	
406700591	6	102	10	
406700609	10	103	10	
406700617	15	104	10	
406700625	20	105	10	
406700633	25	106	10	
406700641	30	107	10	
406700658	40	108	10	
406700674	50	109	8	
406700682	60	110	6	
406700690	70	111	6	
402328926	0.18 Alarm Fuse			
408548944	Bullet Fuse Holder, TFD-101-011-09 (Alarms on Blown Fuse or Fuse Head Removal)			
CC408617410	Bullet Fuse Holder, TFD-101-011-10 (Alarms on Blown Fuse Only)			

Step 4: Select Distribution Components (Continued)

GMT Fuses

ORDERING CODE	AMERAGE	WP-92461 LIST	MIN WIRE GAUGE	PHOTO
405006222	0.25 A			
406976894	0.5 A			
405673146	1.33 A			
405181983	2 A			
406976985	3 A			
406159061	5 A			
405725433	7.5 A			
406159236	10 A			
406473959	15 A			
408515823		Fuse Puller		

Step 5A: Monitoring Options - Remote Peripheral Monitoring (Millennium 2 Controller Only)

ORDERING CODE	MODULES	# INPUTS	# TEMP	PHOTO
108469461	J85501G1L21 RPM Shunt Monitoring (221F)	6	1	
108469479	J85501G1L22 RPM Voltage 0-200 VDC (221D)	6	1	
108469495	J85501G1L23 RPM Transducers (221J)	6	1	
108298431	J85501G1L24 RPM Voltage 0-3 VDC (221A)	6	1	
108298498	J85501G1L25 RPM Voltage 0-16 VDC (221B)	6	1	
108469503	J85501G1L26 RPM Voltage 0-70VDC (221C)	6	1	
108298449	J85501G1L27 RPM Binary (222A)	6	1	
108483538	J85501G1L28 RPM Temperature (223T)	0	7	
108298456	J85501G1L9 RPM Control Relay (214A)	3	0	

Supporting Materials - as needed

ORDERING CODE	DESCRIPTION	PHOTO
407377704	Connecting Cable for RPMs (Order by foot)	
848535332	Blue panel for mounting 6 modules above a GPS cabinet	
848412367	White panel for mounting 6 modules in a 23-inch frame inside GPS bay	
847307410	12' Cable to be used with Temperature Probes	
847917879	½" Diameter Ring Terminal Temperature Probe (Cable Required)	
848528881	5/16" Diameter Ring Terminal Temperature Probe (Cable Required)	
405298308	Termination Resistor (1 per bus)	
406712968	Ferrite Bead (1 per bus)	
108984477	23" grey panel, 6 RPM mounting panel	
403700198	WIRE KS22247 L4 20 GA PR STD R/O for connecting RPM channels (order by foot)	

Step 5A: Remote Peripheral Monitoring Option (continued)

OUTLINE DRAWING

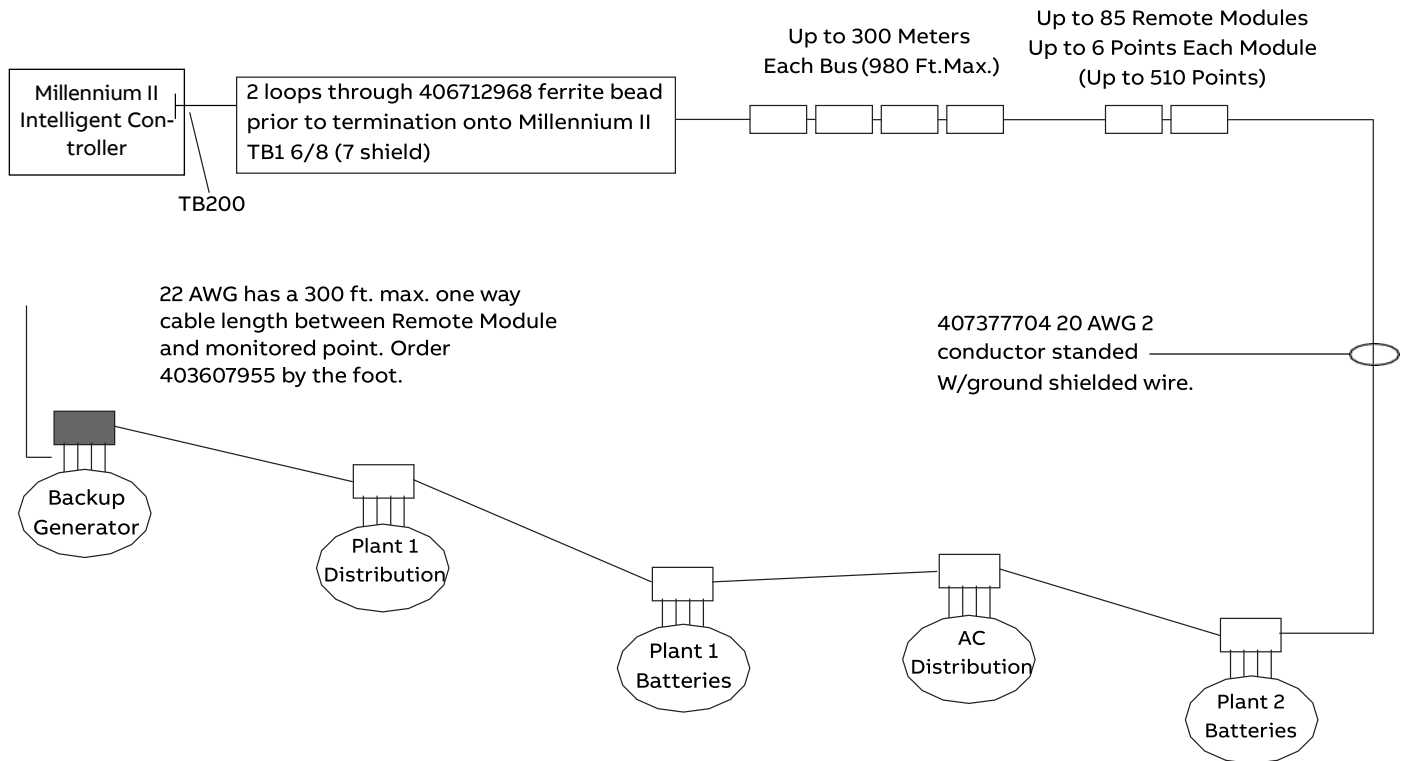

- Denotes Remote Monitoring Modules
- Denotes Last Remote Monitoring Module on bus. A 560 ohm, 10 watt Terminating Resistor is required for proper operation.

Step 5B: Monitoring Options

Battery Monitoring

ORDERING CODE	DESCRIPTION	PHOTO
CC109142980	QS873A Thermal Probe (A)	
CC848817024	10 ft wire set (B: thermal probe to controller)	
CC109157434	20 ft wire set (B:thermal probe to controller)	
CC848822560	1 ft wire set (C: thermal probe to thermal probe)	
848719803	5 ft wire set (C: thermal probe to thermal probe)	
CC848822321	10 ft wire set (C: thermal probe to thermal probe)	
850027334	20 ft wire set (C: thermal probe to thermal probe)	
108958422	ES771A Battery Voltage Monitor Card	
CC848791517	2-1/2 ft wire set (D: ES771A to thermal probe)	
108984477	23" grey panel, 6 RPM mounting panel for Lorain plants	
CC848797290	6 ft wire set (D: ES771A to thermal probe)	
848719829	10 ft wire set (D: ES771A to thermal probe)	
CC848791500	4 ft wire set (G: ES771A to ES771A or controller)	
848652947	10 ft wire set (G: ES771A to ES771A or controller)	
555052-1	In-Line Coupler	

Step 5B: Monitoring Options (Pulsar) (Continued)

OUTLINE DRAWING

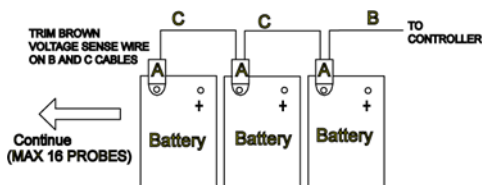

Temperature Measurement

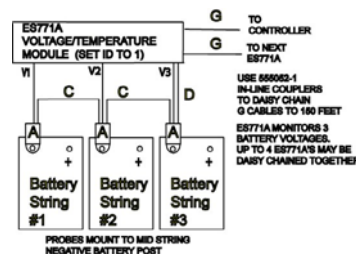

Temperature and Voltage Measurement

Temperature/Voltage probes are needed for battery monitoring. They are connected to each battery or battery string to provide slope thermal compensation, temperature alarms and voltage imbalance alarms

Step 6: Select Optional AC Monitoring Equipment (Millennium 2 Controller Only)

Configured Panels

ORDERING CODE	DESCRIPTION	PHOTO
CC408646005	3P/3W 208/240V Line to Line, 10x12x14 box provides current, voltage, and power	
CC408646046	3P/3W 480V Line to Line, 10x12x14 box provides current, voltage, and power	
CC408646054	3P/4W 208V Line to Neutral, 10x12x14 box provides current, voltage, and power	

Transducers

ORDERING CODE	DESCRIPTION	PHOTO
CC408645808	1-phase AC Current Transducer (Built-in CT; 150A max current; 350 kcmil max conductor size)	
CC408645816	1-phase AC Voltage Transducer 120V	
CC408645824	1-phase AC Voltage Transducer 208/240V	
CC408644537	3-phase AC Voltage Transducer 208/240V Line to Line	
CC408645741	3-phase AC Voltage Transducer 208/240V Line to Neutral (120V)	
CC408645832	3-phase AC Voltage Transducer 480V Line to Line	
CC408645840	3-phase AC Current Transducer	

Step 6: Select Optional AC Monitoring Equipment (Continued)

Current Transformers (Required for Configured Panels and Current Transducers)

ORDERING CODE	DESCRIPTION	PHOTO
CC408645857	Current Transformer, 200A primary, 5A secondary, 4 in inside diameter	
408524862	Current Transformer, 400A primary, 5A secondary, 4 in inside diameter	
CC408645865	Current Transformer, 600A primary, 5A secondary, 6 in inside diameter	
CC408645873	Current Transformer, 800A primary, 5A secondary, 6 in inside diameter	
CC408645881	Current Transformer, 1,000A primary, 5A secondary, 8 in inside diameter	
CC408645898	Current Transformer, 1,200A primary, 5A secondary, 8 in inside diameter	

Miscellaneous

ORDERING CODE	DESCRIPTION
CC408645907	Barrier terminal block to extend the CT secondary leads beyond their 12 ft factory length. Use 12 AWG THHN wire in conduit.
CC408645915	Bud Industries Wall Box (12H x 10W x 8D) w/captive screw cover & internal mounting panel. For mounting transducers

Step 7: Select Battery Termination Options

Order optional termination bar if standard 8 positions may be exceeded

ORDERING CODE	DESCRIPTION
1600098086A	Bus bar extension kit. Included with cabinet assembly when ordered as group G201.
848385878	Optional adapter that allows two lugs to be stacked and connected at one location. (Provides one adapter)

OUTLINE DRAWING

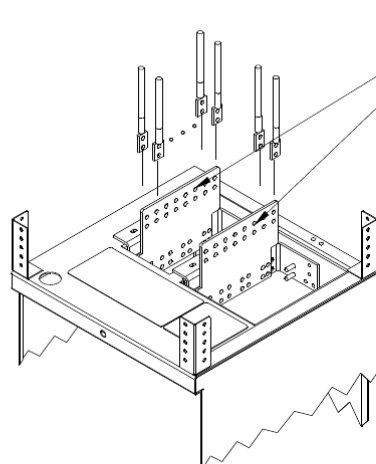

1600098086A

KIT CONTAINS (2) 8600097665P BUS BAR AND HARDWARE
 PROVIDES 16 OUTPUT TERMINATIONS (ON 1.25" CENTERS) OR
 10 OUTPUT TERMINATIONS (ON 1.80" CENTERS)

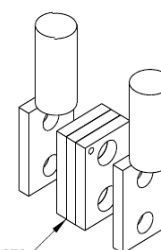

848385878
 LUG ADAPTER

Step 8: Select Optional External Bus Bars

Bay to Bay Interconnect Kits

ORDERING CODE	DESCRIPTION	NOTES
150023060	External interconnection bus kit rated for 1800 amps	DO NOT mix 1,800A and 5,000A bars in the same system
150022833	External interconnection bus kit rated for 5000 amps	

External Return Bus Kits

ORDERING CODE	DESCRIPTION
CC848805160	External Return 90 Deg Kit: Option for termination of all distribution return cables. 1 per cabinet, 22 sets of 0.375" dia holes on 1.00" centers and 7 sets of 0.250" dia holes on 0.625" centers. The external return bus kit is an alternative to internal return buses when many large cables are required (see fig. below).
150047508	External Return 45 Deg Kit: Option for termination of all distribution return cables. 1 per cabinet, rated at 1800 Amps. 22 sets of 0.375" dia holes on 1.00" centers and 7 sets of 0.250" dia holes on 0.625" centers.
1600093385A	External interconnection bus cover kit configurable for 90 and 45 degrees

OUTLINE DRAWING

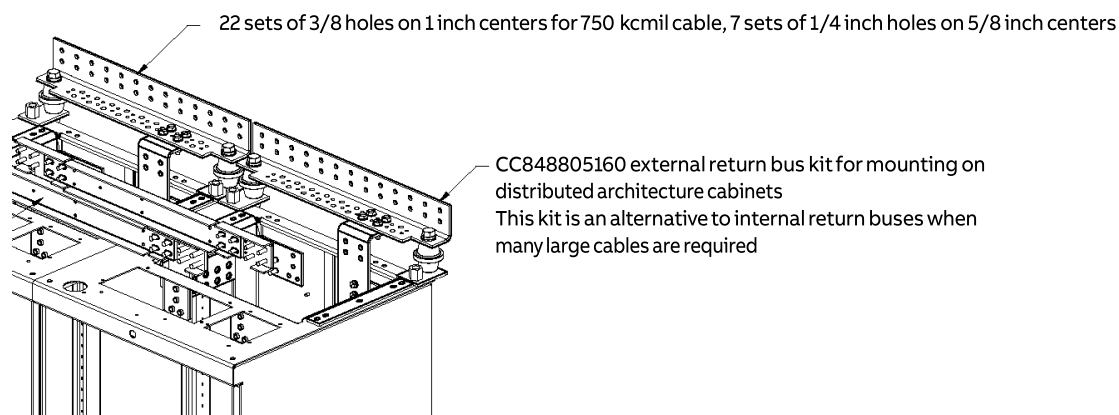

16. IF 750 KCMIL CLASS B LOAD LEADS ARE DESIRED, YOU MAY ORDER 848698338 CABLE SET THAT PROVIDES 15FT OF 407399526 KS24194 L2 4/0 WIRE WITH WP91412 L27 LUG ON ONE END AND 750 KCMIL CLASS B TO 4/0 CLASS I BURNDY BUTT SPLICE ON THE OTHER. THIS BUTT SPLICE TAKES UP MUCH LESS SPACE ON THE CABLE RACK THAN THE TYPICAL C-TAP

Management Visibility

Galaxy Manager software from ABB is a centralized visibility and control software offering that provides comprehensive power management capability, and is designed to meet the needs of engineering, operations and maintenance. Galaxy Manager uses a client-server architecture that enables remote access to system controllers across the power network. Features included in Galaxy Manager software include:

- Dashboard display with one-click access to management information database
- Trend analysis
- Scheduled or on demand reports
- Fault, configuration, asset, and performance management

Training

ABB offers on-site and classroom training options based on certification curriculum. Technical training can be tailored to individual customer needs. Training enables customers and partners to more effectively manage and support the power infrastructure. We have built our training program on practical learning objectives that are relevant to specific technologies or infrastructure design objectives.

Service & Support

ABB field service and support personnel are trusted advisors to our customers always available to answer questions and help with any project, large or small. Our certified professional services team consists of experts in every aspect of power conversion with the resources and experience to handle large turnkey projects along with custom approaches to complex challenges.

Proven systems engineering and installation best practices are designed to safely deliver results that exceed our customers' expectations.

Warranty

ABB is committed to providing quality products and solutions. We have developed a comprehensive warranty that protects you and provides a simple way to get your products repaired or replaced as soon as possible.

For full warranty terms and conditions please go to abbpowerconversion.com

Notes

ABB

601 Shiloh Rd.
Plano, TX USA

abbpowerconversion.com

We reserve the right to make technical changes or modify the contents of this document without prior notice. With regard to purchase orders, the agreed particulars shall prevail. ABB does not accept any responsibility whatsoever for potential errors or possible lack of information in this document.

MAN0040500 Rev. 4

We reserve all rights in this document and in the subject matter and illustrations contained therein. Any reproduction, disclosure to third parties or utilization of its contents – in whole or in parts – is forbidden without prior written consent of ABB.

Copyright© 2021 ABB
All rights reserved