

INSTALLATION GUIDE

H2007001 G11 Series

Infinity D Power System

with +24 Volt Rectifiers, -48 Volt Converters, and Pulsar Controller

Table of Contents

1. Introduction.....	4
Document Objectives	4
Audience.....	4
Applications.....	4
Customer Service Contacts.....	5
2. Product Description	6
Overview	7
3. Safety	9
Safety Statements.....	9
Warning Statements and Safety Symbols.....	11
Precautions.....	12
Handling Batteries.....	13
Special Installation Notes.....	14
Deutsch.....	14
Español.....	15
4. Installation	18
Preparation	18
Anchor the Frame	21
Ground the Framework.....	21
Connect Frame Ground	21
Install Batteries.....	22
Mount the Subframe System to the Frame or Cabinet.....	23
Wire the Subframe.....	24
Identify Areas for Each Type of Wiring	24
Connect ac Utility	25
Wire the Battery Connection Module.....	30
Connect Central Office Ground (COG).....	31
Connect External Battery Cables	32
Wire +24V DC Loads.....	36
Install dc Bullet Style Circuit Breaker Modules for +24V Loads	37
Wire -48V DC Loads.....	41
Install dc Bullet Style Circuit Breaker Modules for -48V Loads.....	42
Wire Loads served by GMT Type Fuses.....	46
Install Rectifiers and Converters	48
Rectifier/Converter Installation Procedure	49
Install Battery Instrumentation	51
Install Battery VT Probes.....	52
Setup Pulsar Controller.....	57
Install Controller Field Wiring.....	58
Change LAN to Server Mode.....	59
Restore the LAN Connection to Client Mode.....	60
Acceptance Testing.....	61
5. Troubleshooting	64
Troubleshooting NE-Series Rectifiers/Converters.....	65

Troubleshooting VT-Probes.....	66
6.Product Warranty	67
Appendix A: Pulsar Controller.....	69
User Interface Overview.....	69
Menu Navigation Buttons.....	70
System Status Display.....	70
LCD Backlight.....	70
NE843 Status LEDs.....	71
Audible Alarm.....	71
Voltage Test Jacks.....	72
Local and Remote Access Ports.....	72
Front Panel Menu Structure.....	73
Front Panel PIN.....	74
Front Panel Menu Flow.....	76
Appendix B: Reference Information.....	81
Pulsar Controller Field Wiring Connector Definitions.....	81
Reference Information for 26 inch Frame.....	83
Revision History	84

1. Introduction

Document Objectives

This manual provides installation and maintenance information for the OmniOn Infinity D power system:

- Safety Information
- Product Description
- Installation Procedures
- Test and Acceptance
- Troubleshooting, including Controller and Rectifier Operations
- Product Warranty

Audience

- Equipment Installers – Instructions for installation, test, and acceptance.
- Equipment Users – Plant basics and troubleshooting.

CAUTION: This unit must be installed, serviced, and operated only by skilled and qualified personnel who have the necessary knowledge and practical experience with electrical equipment and who understand the hazards that can arise when working on this type of equipment.

Additional Product Documentation

- 2007001 Ordering Guide:
- Configuration and Ordering Information
- Specifications of System, Rectifiers, Converters, and Controller
- Spare and Maintenance Parts Lists
- Engineering Information, such as ac Service Breakers, Conduit and Wiring Sizing, and dc Wiring Information.

Applications

Infinity D represents the state-of-the-art high density power system with a 18x26x84 inch footprint that are suited for sites ranging from 75A to 1600A power requirements. The +24Vdc power system provides 960 amperes at the 80% load capacity with a +24 to -48Vdc converter shelf that provides four 30 ampere units for a total of 120 amps supporting a different voltage than the +24Vdc principal battery voltage.

Customer Service Contacts

Customer Service, Technical Support, Product Repair and Return, and Warranty Service

For customers in the United States, Canada, Puerto Rico, and the US Virgin Islands, call

1-800-THE-1PWR (+86-21-53899666). This number is staffed from 7:00 am to 5:00 pm Central Time (zone 6), Monday through Friday, on normal business days. At other times this number is still available, for emergencies only. Services provided through this contact include initiating the spare parts procurement process, ordering documents, product warranty administration, and providing other product and service information. For other customers worldwide the 800 number may be accessed after first dialing the OmniOn Direct country code for the country where the call is originating, or you may contact your local field support center or your sales representative to discuss your specific needs.

Customer Training

OmniOn Power offers customer training on many Power Systems products. For information call

+86-21-53899666. This number is answered from 8:00 a.m. until 4:30 p.m., Central Time Zone (Zone 6), Monday through Friday.

Downloads and Software

To download the latest product information, product software and software upgrades, visit our web site at

[omnionpower.com](https://www.omnionpower.com)

2. Product Description

Overview

Shown here is an Infinity D equipment only frame made up of six Infinity D Power Modules. Three different modules are shown: one Battery Connection Module, four Rectifier System Modules and one Converter System Module. Principal elements are labeled:

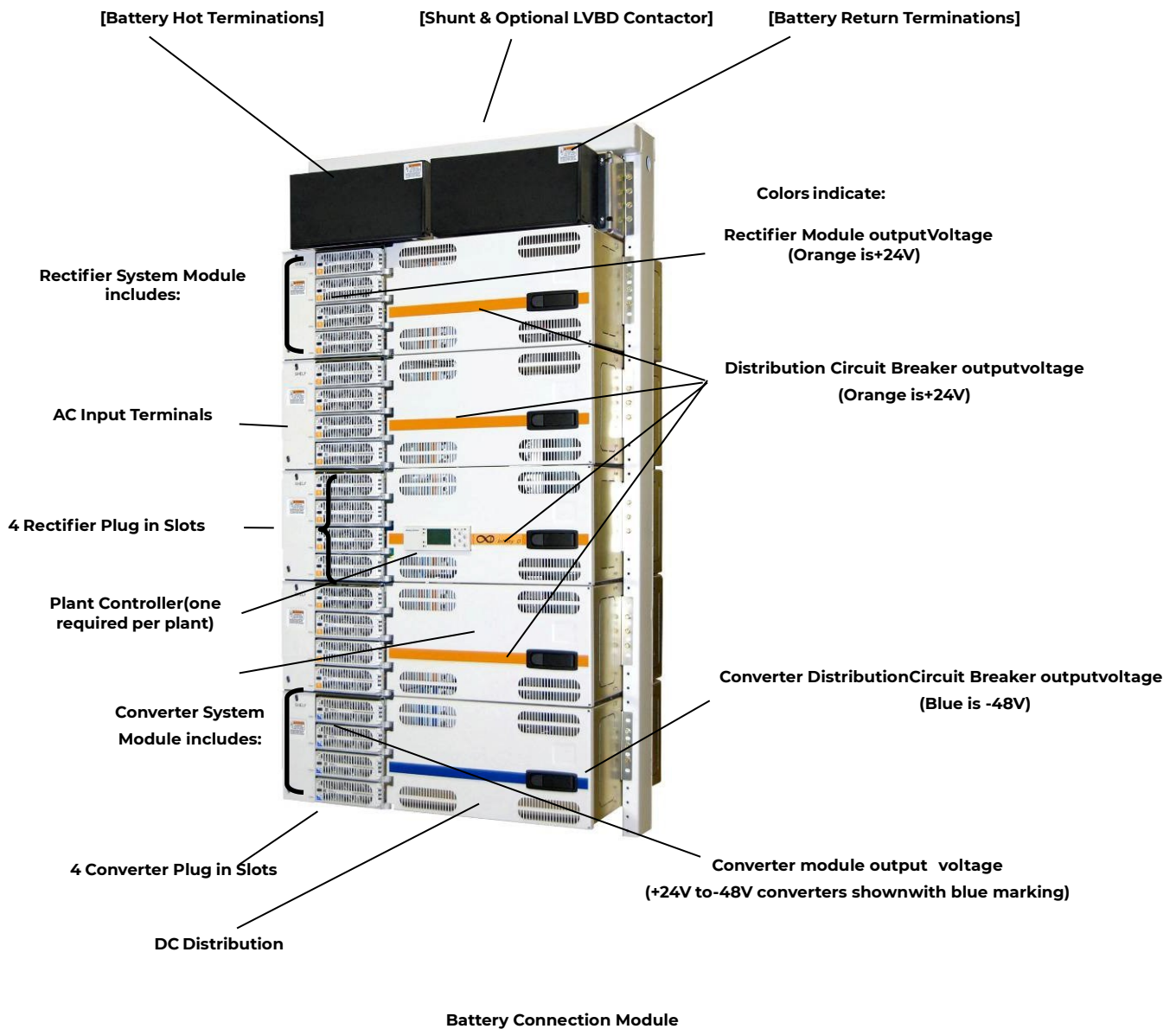

Battery Connection Module

Batteries power the load equipment when ac input to the rectifiers is lost. The batteries are connected to the Battery Connection Module at the top of the frame. An optional Low Voltage Battery Disconnect (LVBD) contactor provides deep discharge protection if desired. The System Shunt also resides in the Battery Connection Module.

Rectifier System Module

On the left side of each Rectifier System Module ac is supplied to front accessible terminal blocks that feed each of the 4 rectifier positions.

The rectifier positions are labeled 1 through 4 from the bottom to the top. At product introduction, all NE rectifiers operate from 208 to 240VAC nominal.

The DC Distribution provides 10 bullet circuit breaker positions per Rectifier System module, with room to optionally add 10 more.

Pulsar Controller

The Pulsar system controller monitors and controls system operation. It is required for all remote telemetry, dry contact alarm closures and precise control of battery voltage.

Converter System Module

The converter positions are labeled 1 through 4 from the bottom to the top. Converters for this plant are available to convert from +24V to -48V.

The DC Distribution provides 10 bullet circuit breaker positions per Converter System module. An alternative distribution will add 10 more for a total of 20.

Frame

By simply changing the door, this system can be configured to work with frame sizes of 19", 23", and 26" frameworks. Preconfigured part numbers for modules that fit into each framework are available in the sizes common for most applications. Growth is achieved by adding one of these supplementary modules. Installation instructions ship with each module.

Frame Size	19"	23"	26"
+24V Rectifier System Module	H2007001 G010E or F	H2007001 G010C or D	H2007001 G010A or B
+24 to -48V Converter System Module	H2007001G030E	H2007001G030C	H2007001G030A

Infinity D Block Diagram

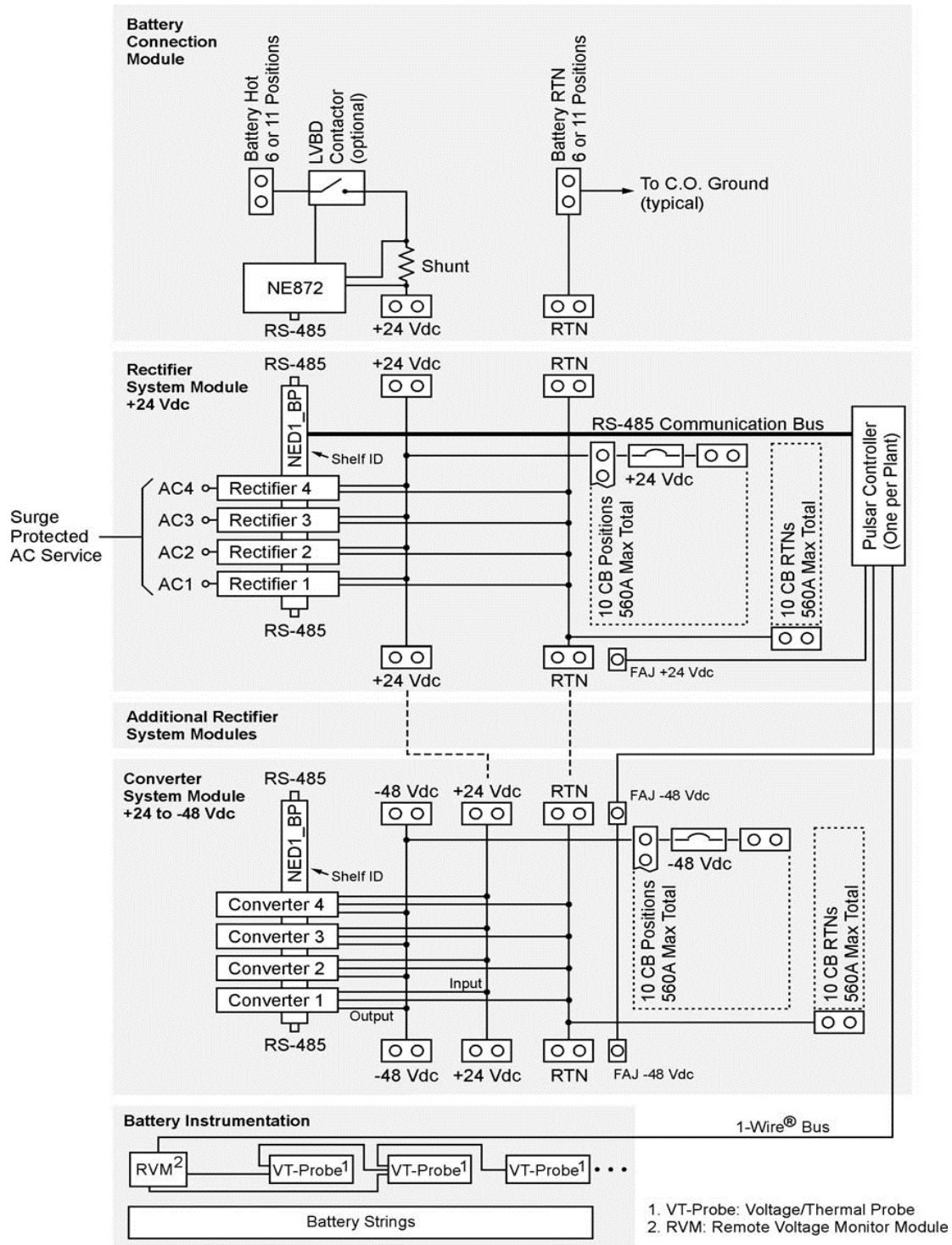

Note on AC surge protection requirements: Our rectifier product Safety Approval is performed to assure safe and reliable performance in IEC 60664-1 Installation CategoryII environments. Building AC surge protection devices installed prior to the rectifiers must provide this degree of protection.

3. Safety

Safety Statements

Please read and follow all safety instructions and warnings before installing, maintaining, or repairing the Lineage power system:

- The CE Mark demonstrates compliance with the European Union Council Directives for Low Voltage and EMC.
- This system is Underwriters Laboratories (UL) Listed per Subject 1801, Power Distribution Centers for Telecommunications Equipment (UL 60950-1).
- Install only in restricted access areas (dedicated equipment rooms, equipment closets, or the like) in accordance with articles 110.27 of the U.S. National Electric Code (NEC), ANSI/NFPA No. 70, and pursuant to applicable local codes.
- Not for use in a computer room as defined in the Standard for the Protection of Electronic Computer/Data Processing Equipment, ANSI/NFPA 75.
 - Ne peut être utilisé dans une salle d'ordinateurs telle que définie dans la norme ANSI/NFPA 75 Standard for Protection of Electronic Computer/Data Processing Equipment
- This equipment is to be used in controlled environments (an area where the humidity is maintained at levels that cannot cause condensation on the equipment, the contaminating dust is controlled, and the steady-state ambient temperature is within the range specified).
- This equipment has been evaluated for continuous use in ambient temperature from -40°C to 45°C. Maximum 45°C ambient for plant outputs not exceeding 960A charge and 1200A discharge, otherwise maximum 40°C ambient.
- This equipment must not be installed over combustible surfaces.
- For installations in the United States, Listed compression connectors are to be used to terminate Listed field-wired conductors where required. For all installations, the appropriate connector is to be applied only to the correct size conductor as specified by the connector manufacturer, using only the connector manufacturer's recommended tooling or tooling approved for that connector.
- If the proper connector for the country of installation is not provided, obtain appropriate connectors and follow manufacturers and all local requirements for proper connections. All national and local rules and regulations should be followed when making field connections.
- The main output voltage (less than 60Vdc for all configurations) meets SELV requirements. Loads connected between -48 volts and +24 volts are not SELV and therefore shall not be connected.
- Insulation on field-wired conductors should be rated no less than 90°Celsius. Wire conductor size should be sized per electrical codes for 75°Celsius wire, and based on the ampacity of the associated protection device. Wiring internal to enclosed equipment cabinets should be rated at 105°Celsius (minimum).
- Torque electrical connections to the values specified on labels or in the product documentation.
- Battery input cables must be dressed to avoid damage to the conductors (caused by routing around sharp edges or routing in areas where wires could get pinched) and undue stress on the connectors.
- Alarm contacts on the office alarm board are not fused; therefore, current limiting protection for these contacts must be provided by external circuits. Maximum ratings for alarm connections are 60Vdc and 0.5 amperes. Exceeding these maximum ratings could result in fire or damage to the unit.
- Fuse and/or circuit breaker loads must not exceed 80% of the fuse and/or circuit breaker current rating. Distribute loads across the panel.
- The short circuit current capability of the battery input to the distribution panel must not exceed 10,000A.
- Wiring methods used for the connection of the equipment to the AC Mains Supply shall be in accordance with the National Electric Code, ANSI/NFPA 70, and the Canadian Electrical Code, Part 1, CSA C22.1. Maximum 20 A protective device is required for each branch circuit powering one power supply. Maximum 40 A protective device is required for each branch circuit powering two power supplies. Refer to the equipment ratings to assure rating of equipment will not exceed 80% of the value of the protector chosen.

- High leakage currents are possible due to contribution from simultaneous multiple ac input connections. Earth ground connection is essential before connecting the ac source to the shelf. This connection is achieved by bonding the AC grounding conductor(s) to the AC grounding terminal(s).
- DC Ground System: Due to potentially high DC fault currents, the rack should first be connected to the office DC ground system per the appropriate telecom industry practices. This Ground connection should be made before any DC power or the AC connections are made to avoid the possibility of damaging the AC ground if a DC fault should occur.
- Readily accessible disconnect/protection device(s) must be incorporated in the building installation wiring in order to remove power from the equipment in the event of an emergency or required servicing.
- Disconnect all ac branch circuits prior to servicing. Multiple sources of ac may be present.









CAUTION – DOUBLE POLE/NEUTRAL FUSING

ATTENTION. Double pôle/fusible sur le neutre.

- Installing fuses or circuit breakers not specified for use in these distribution modules may result in injury to service personnel or equipment damage. Use only replacement parts listed in this manual and on the equipment drawings.
- The telecom-type (for example, GMT type) fuses can produce sparks during interruption or clearing of a fault on a high energy circuit. Use only fuses provided with safety caps for this type of circuit. Installing telecom-type fuses not equipped with safety caps may result in injury to service personnel.
- While installing batteries, follow all safety precautions outlined in the appropriate battery product manuals.
- The intra-building port(s) of the equipment or subassembly is suitable for connection to intrabuilding or unexposed wiring or cabling only. The intra-building port(s) of the equipment or subassembly **MUST NOT** be metallically connected to interfaces that connect to the OSP or its wiring. These interfaces are designed for use as intra- building interfaces only (Type 2 or Type 4 ports as described in GR-1089-CORE, Issue 4) and require isolation from the exposed OSP cabling. The addition of Primary Protectors is not sufficient protection in order to connect these interfaces metallically to OSP wiring. The Ethernet port is suitable for connection only to shielded intra-building cabling grounded at both ends.

Warning Statements and Safety Symbols

The symbols may sometimes be accompanied by some type of statement; e.g., “Hazardous voltage/energy inside. Risk of injury. This unit must be accessed only by qualified personnel.” Signal words as described below may also be used to indicate the level of hazard.

<p>DANGER</p>	<p>Indicates the presence of a hazard that will cause death or severe personal injury if the hazard is not avoided.</p>
<p>WARNING</p>	<p>Indicates the presence of a hazard that can cause death or severe personal injury if the hazard is not avoided.</p>
<p>CAUTION</p>	<p>Indicates the presence of a hazard that will or can cause minor personal injury or property damage if the hazard is not avoided.</p>
	<p>This symbol identifies the need to refer to the equipment instructions for important information.</p>
	<p>These symbols (or equivalent) are used to identify the presence of hazardous ac mains voltage.</p>
	<p>This symbol is used to identify the presence of hazardous ac or dc voltages. It may also be used to warn of hazardous energy levels.</p>
	<p>One of these two symbols (or equivalent) may be used to identify the presence of rectifier and battery voltages. The symbol may sometimes be accompanied by some type of statement, for example: “Battery voltage present. Risk of injury due to high current. Avoid contacting conductors with uninsulated metal objects. Follow safety precautions.”</p>
	<p>One of these two symbols may be used to identify the presence of a hot surface. It may also be accompanied by a statement explaining the hazard. A symbol like this with a lightning bolt through the hand also means that the part is or could be at hazardous voltage levels.</p>
	<p>This symbol is used to identify the protective safety earth ground for the equipment.</p>
	<p>This symbol is used to identify other bonding points within the equipment.</p>
	<p>This symbol is used to identify the need for safety glasses and may sometimes be accompanied by some type of statement, for example: “Fuses can cause arcing and sparks. Risk of eye injury. Always wear safety glasses.”</p>

Precautions

When working on or using this type of equipment, the following precautions should be noted:

- This unit must be installed, operated, and serviced, only by qualified technical personnel, who have the necessary knowledge and practical experience with electrical equipment and who understand the hazards that can arise when working on this type of equipment. Equipment in these locations will contain parts at HAZARDOUS energy levels that can be directly accessed and are only protected by guarding and/or warning.
- The equipment may be powered by multiple ac inputs. Disconnect all AC branch circuits before servicing. Do not disconnect grounding, bonding conductors, or permanent bonding provisions unless all ac inputs are disconnected.
- High leakage current exists. Grounding/Earth connection must be provided before connecting supply.
- Batteries may be connected in parallel with the output of the rectifiers. Turning off the rectifiers will not necessarily remove power from the bus. Make sure the battery power is also disconnected and/or follow safety procedures while working on any equipment that contains hazardous energy/voltage.
- Hazardous energy and voltages are present in the unit and on the interface cables that can shock or cause serious injury. Follow all safety warnings and practices when servicing this equipment. When equipped with ringer modules, hazardous voltages will be present on the ringer output connectors.

In addition to proper job training and safety procedures, the following are some basic precautions that should always be used:

- Use only properly insulated tools.
- Remove all metallic objects (key chains, glasses, rings, watches, or other jewelry).
- Wear safety glasses. Fuses can produce sparks. High energy levels on buses and distribution components can produce severe arcing.
- Test circuits before touching.
- Lock out and tag circuit breakers/fuses when possible to prevent accidental turn on.
- Be aware of potential hazards before servicing equipment.
- Identify exposed hazardous electrical potentials on connectors, wiring, etc. (note the condition of these circuits, especially wiring).
- Use care when removing or replacing covers; avoid contacting circuits.

Handling Batteries

- To direct attention to the possible source of danger from battery gases, post one or more warning signs, lettered in large characters, in a conspicuous location near the battery. For example:

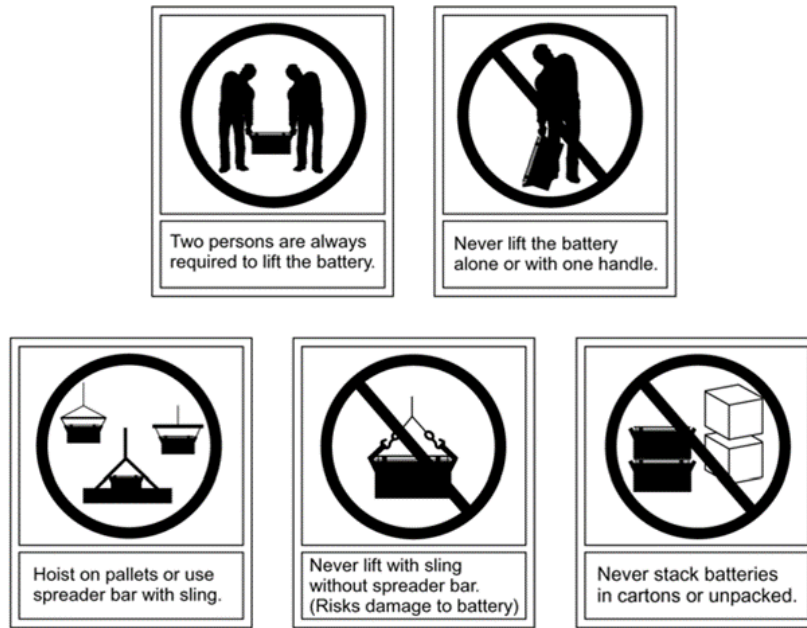

- Fully brief anyone who is permitted access to battery areas on the hazards of handling lead-acid batteries. Make it clear to anyone handling, unpacking, or installing lead-acid batteries that they contain electrolyte (sulfuric acid and water). Everyone must wear protective equipment such as rubber gloves, rubber aprons, full face mask, and splash-proof goggles when performing any activity involving handling of batteries or cells containing electrolyte.
- A storage battery gives no indication by its appearance of the potential energy stored in it. All lead-acid storage cells/batteries have enormous short circuit capability which can result in serious burns. Use extreme care to avoid shorting out cell and/or battery terminals. Shorting a cell or battery with a non insulated tool can vaporize or throw the tool.
- All lead-acid batteries generate hydrogen gas, even under open circuit conditions. If not permitted to escape, this gas can build up to explosive concentrations. NEVER tamper with or block the vent caps of the batteries. A damaged gas vent cap could become clogged, resulting in an explosion due to internal pressure. Such an explosion could short circuit other battery modules and result in a fire. ALWAYS place batteries in a well ventilated area. NEVER place battery modules in a sealed environment.
- In case of electrolyte contact with the skin, remove the electrolyte immediately by flushing the affected area with large amounts of plain tap water. In case of electrolyte in the eye, pour water into the inner corner of the eye and allow at least one quart of water to run over the eye and under the eyelid. Eye injuries should be treated by a physician immediately.

Special Installation Notes

Deutsch

Installationsanleitung

Eingangsspannung (Voltage) : +24, -48

Eingangsstrom (Current) : Max 1200A

Eingangsleistung (Watts) :

Nennfrequenz (Frequency) : 50 / 60 Hz

Seriennummer (Assembly No.) :--

Modellnummer (Model No.) : Infinity NE

Abmessungen sind nur zur Referenz : 660mm x 533.4mm x 2133.6mm

(Dimensions are for reference only)

Max. Umgebungstemperatur : max. 45 deg. C

(Max. Operation temperature)

Achtung: Für kontinuierlichen Feuerschutz sollte die Sicherung nur mit einer des gleichen Types ersetzt werden.

Sicherungswert :

(Warning : For continued protection against fire replace with same type and rating of fuse)

Das System ist ein Gerät der Schutzklasse I / Überspannungs Kategorie II (Power Supply is a Class I equipment / overvoltage category II)

Ausgangsspannungen und -ströme: DC 58 V / SELV

(Output Voltage and Current)

- Das Gerät darf nur in Räumen mit beschränktem Zutritt aufgestellt werden. (Nur ausgebildetes Personal)
- Nur für Aufstellung auf Boden oder einer anderen brennbaren Oberfläche geeignet.
- Das Gerät hat keinen eigenen Ausschalter, es muß daher mit einem Ein- und Ausschalter im Versorgungskreis versehen sein.
- Das Gerät ist für den Einbau in IT- Geräte in einem Rahmen bestimmt (siehe weitere Anleitung)
- Beim Einbau des Gerätes ist darauf zu achten das alle Anforderungen gemäß EN60950 eingehalten werden.

ACHTUNG: HOHER ABLEITSTROM

VOR ANSCHLUSS AN DEN VERSORGUNGSSTROMKREIS UNBEDINGT ERDUNGSVERBINDUNG HERSTELLEN

Español

Notas especiales para instalaciones en países que hablan español.

- Instrucciones de instalación (Installation Instructions)
- Voltaje (Voltage): +24, -48
- Corriente (Current): Max 1200 A
- Frecuencia (Frequency): 50/60Hz
- Voltaje y corriente de salida (Output Voltage and Current):
- Temperatura máxima de operación (Maximum Operation Temperature): 45°C (113°F)
- Sin cabina contra incendios, suelo no combustible (No fire enclosure, non-combustible floor)
- Evaluado en EN60950 (Evaluated to EN60950)

UL Ratings as reflected in the UL Report in May 2009. Please note the available rectifier output is reduced from the nameplate rating when converters are introduced to the system.

Model	J2008001 Battery Panel	Input (ac)		Output (dc)		
		V (50/60Hz)	Current	Vdc (++)	Max Current(+++)	Max Power
H2007001 Type A(+)	L001, L002, L005, or L006 L003, L004, L007, or L008	200-240 (up to 28 feeds)	15 A draw	22 – 29	640A charge 800A discharge	17,500 W
					1280A charge 1600A discharge	34,985 W
H2007001 Type B(+)	L001, L002, L005, or L006	200-240 (up to 28 feeds)	15 A draw	Primary:22 – 29	Primary: 640A charge 800A discharge	17,500 W maximumcombined output
				Secondary: 48 – 54.5	Secondary: 120A	
	L003, L004, L007, or L008	200-240 (up to 28 feeds)	15 A draw	Primary:22 – 29	Primary: 1280A charge 1600A discharge	34,985 W maximum combinedoutput
				Secondary: 48 – 54.5	Secondary: 120A	
H2007001 Type C(+)	L001, L002, L005, or L006 L003, L004, L007, or L008	200-240 (up to 28 feeds)	15 A draw		640A charge 800A discharge	34,880 W
				44 – 57	1280A charge 1600A discharge	69,760 W
H2007001 Type D(+)	L001, L002, L005, or L006	200-240 (up to 28 feeds)	15 A draw	Primary:44 – 57	Primary: 640A charge 800A discharge	34,880 W maximumcombined output
				Secondary:24– 27.25	Secondary:300A	
	L003, L004, L007, or L008	200-240 (up to 28 feeds)	15 A draw	Primary:44 – 57	Primary: 1280A charge 1600A discharge	69,760 W maximumcombined output
				Secondary:24– 27.25	Secondary:300A	

ELECTRICAL RATING:

(+) - May be followed by –SD. When followed by –SD, the AC input will be up to 16 or 8 feeds rated: (16)x 15 amps each feed or (8)x 30 amps each feed.

(++) - The marked output voltage may be any voltage range or specified voltage as long as it is within the range specified in the electrical rating table.

(+++)- Maximum 45°C ambient for output rating not exceeding 960A charge and 1200A discharge. Otherwise, 40°C ambient. The secondary (converter) input is a load for the primary (rectifier) output. This must be considered when loading the plant to its maximum rated primary output.

DC DISTRIBUTION PANEL OVERCURRENT-PROTECTION DEVICE CONFIGURATIONS

Shelf(+)	Maximum Amps(++), (+++)	Circuit Breakers			Comments
		Manufacturer	Series	Rating(+++++)	
J2007002	400 charge 500 discharge	Airpax	LMLK, LMLHPK	3-70A 1-pole 100A 2-pole 150A 2-pole 250A 3-pole	Cumulative adjacent circuit breaker ratings cannot exceed 250A.
		Lineage Power	QSGMT6	6 fuse holders – 57.6A total; 15A rated fuse/position	R/C (QPQY2/8); uses R/C fuse (JDYX2) by SOC, Type AX1 or AX1-B
			J2007002 L005 (++++)	3-70A 1-pole 100A 2-pole	Cumulative circuit breaker ratings cannot exceed 200A.

(+) - Includes all List options.

(++) - Maximum amps that the distribution section of the shelf is rated. Power supply output may be rated less.

(+++)- Plant ratings that exceed 640A charge and 800A discharge: top shelf adjacent to battery panel shall not exceed 336A charge and 400A discharge.

(++++)- The J2007002 L051 shelf option is ten additional bullet-breaker positions located on right side of shelf.

(+++++)- Plant ratings that exceed 640A charge and 800A discharge: top shelf adjacent to battery panel shall not use either a 150A 2-pole or 250A 3-pole circuit breaker.

POWER SUPPLIES ALLOWED IN H2007001 POWER DISTRIBUTION CENTER

Power Supply Model(#)	Type	Manufacturer	Certification
NE075AC24	rectifier	OmniOn	R/C (QQGQ2/QQGQ8)
NE030DC48	converter		
NE100AC24	rectifier		
NE050AC48	rectifier		
NE075DC24	converter		

(#) - May be provided with a non-safety affecting suffix.

4. Installation

Preparation

Safety

Please review all safety warnings in Section 3 before beginning the installation process. Observe all warnings and labels on the equipment.

WARNING: Due to the possibility of working on energized circuits during these procedures, all tools and test equipment must be insulated in an approved manner. Proper ESD protection is required in order to prevent ESD damage to the equipment.

WARNING: Only qualified personnel should install and service the power system and plug-in modules. Hazardous energy and voltages are present in the unit and on the interface cables and will shock or cause serious injury or death if safety precautions are ignored. Follow all safety warnings and practices when servicing this equipment.

Installation Sequence

1. Anchor the Frame
2. Ground the Framework
3. Install Batteries
4. Connect ac Utility
5. Connect Central Office Ground
6. Connect External Battery Cables
7. Wire +24 V dc loads and circuit breakers
8. Wire -48 V dc loads and circuit breakers
Install Rectifiers and Converters
9. Install Rectifiers and Converters
10. Install Battery Instrumentation

Wiring Guidelines

- All electrical connections should be made using the proper crimping tools and dies and should be torqued to values specified.
- All building wiring should comply with the NEC and other applicable local codes.
- The temperature rating of the wire must be 90°C minimum. Wire gauge must be sized based on 75°C wire and the ampacity of the associated branch-circuit protection.
- Wiring internal to enclosed equipment cabinets must be rated no less than 105°C Celsius.

Packaging

- All packages should be opened with a box cutter with the blade minimally exposed so that only the sealing tape is cut.
- Save all packaging material until the system has been powered up and all parts are operating within specifications.

Installation Tools

You will need the following tools to install and test the Infinity D.

- Wire cutters and strippers
- Heat shrink gun
- 5/16-inch (8 mm) hex driver
- Digital meter with an accuracy of $\pm 0.02\%$
- Screw drivers (flat-blade and Phillips)
- ESD wrist strap
- 24 or/and 48V test load
- Calibrated clamp-on dc currentmeter (0.1 ADC sensitivity)
- Torque wrench
- Socket wrenches:
 - 7/16" and 9/16" for load and battery connections;
 - 19 mm for anchor bolts;
- 12" extension for socket
- Masonry drill kit as required
- Compression for installation of various compression lugs
- Protective canvas
- Insulating rubber mat
- Standard insulated installation tools, screwdrivers, etc.
- Required Insulated Tool Kit 1000vDC Telecom set to include ESD protection.

Anchor the Frame

Floor Mounted Frames

Mount the selected frame securely to the floor using floor anchors rated for the Seismic Zone of the site. We sell a floor anchor kit (847135688) with 4 Hilti 12mm Cap bolts that may be appropriate for the frame you have selected.

Step	Action
1.	Mark floor using template, frame itself, or measurements in Appendix B if 26" frame selected.
2.	Drill anchor holes. Caution: Follow safe floor drilling procedures to prevent possible asbestos exposure.
3.	Place frame and install floor anchors according to manufacturer requirements.

Battery or Battery Stand Mounted Half- and Third-Height Frames:

Step	Action
1.	Place and secure frame to battery or battery stand per instructions provided with the battery stand or adapter.

Ground the Framework

Connect Frame Ground

Step	Action
1.	Select a Frame Ground landing on the top cross rail of the frame, or on the bottom or the rack rails depending on frame and site parameters.
2.	Remove covering tape and clean. If required by local code or practice, treat with an oxidation inhibitor such as NO-OX.
3.	Secure Frame Ground connection Use 7/16" socket. Torque to 65 in·lbs. (7 Nm)

Battery or Battery Stand Mounted Frames:

If required by local code or practice, battery or battery stand mounted frames may be grounded to the frame or chassis of the other equipment. Select a Frame Ground landing at the side of the frame and clean.

Step	Action
1.	Select a Frame Ground landing at the side of the frame and clean.
2.	Remove covering tape and clean. If required by local code or practice, treat with an oxidation inhibitor such as NO-OX.
3.	Secure Frame Ground connection. Use 7/16" socket. Torque to 65 in·lbs. (7 Nm)

Install Batteries

WARNING: All batteries contain hazardous electrical energy. Lead-acid batteries contain sulfuric acid and explosive hydrogen gas. Follow all precautions noted in the literature accompanying the batteries. Use only insulated tools.

CAUTION: Equipment frame anchoring, load rating, and seismic zonerating should be verified before field installing trays and batteries.

Installing External Batteries

Step	Action	
1.	Place batteries on battery trays, battery stands, or other satisfactory supporting surface and interconnect per manufacturer's instructions to create 24V or 48V strings as required.	
	Is an external disconnect switch being used?	
2.	Yes - physically mount switch to an appropriate place and ensure it is in the OFF position prior to making any connections.	No – Finished.
3.	Connect the battery hot conductor (s) to the line side of the disconnect switch and torque connection per manufacturer's specification.	
4.	Connect the load side conductor to the disconnect switch and torque connection per manufacturer's specification.	

Mount the Subframe System to the Frame or Cabinet

The Infinity D is provided in integrated Subframes. Each Subframe contains one BatteryConnection Module, one Pulsar Controller and one or more Rectifier System Modules. Converter System Modules are not required to have a valid system and are typically on the bottom of the power equipment stack in any given Subframe. Step 1 below shows the elements included in the smallest valid Subframe.

Step	Action
1.	<p>Mount the Subframe to the rack.</p> 
2.	<p>Use the fasteners and torque values provided by the frame supplier to secure flanges on the right and left hand frame rails. Use at least 2 rack screws per side for each element in the Subframe. This Subframe requires at least 8 rack screws.</p>

Wire the Subframe

Identify Areas for Each Type of Wiring

The Infinity D is designed for overhead wiring.

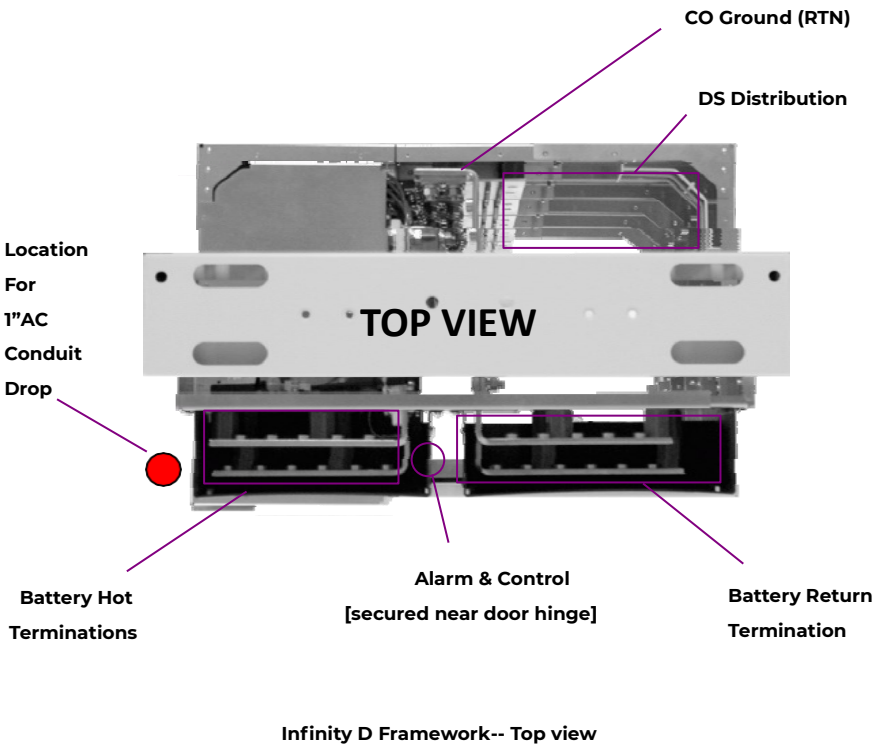
Step	Action
<p>1.</p>	<p>Look at the framework from the top.</p>  <p style="text-align: center;">Infinity D Framework-- Top view</p>
<p>2.</p>	<p>Address: CO Grounding, AC wiring, Battery wiring, DC wiring and Alarm & Control wiring.</p>

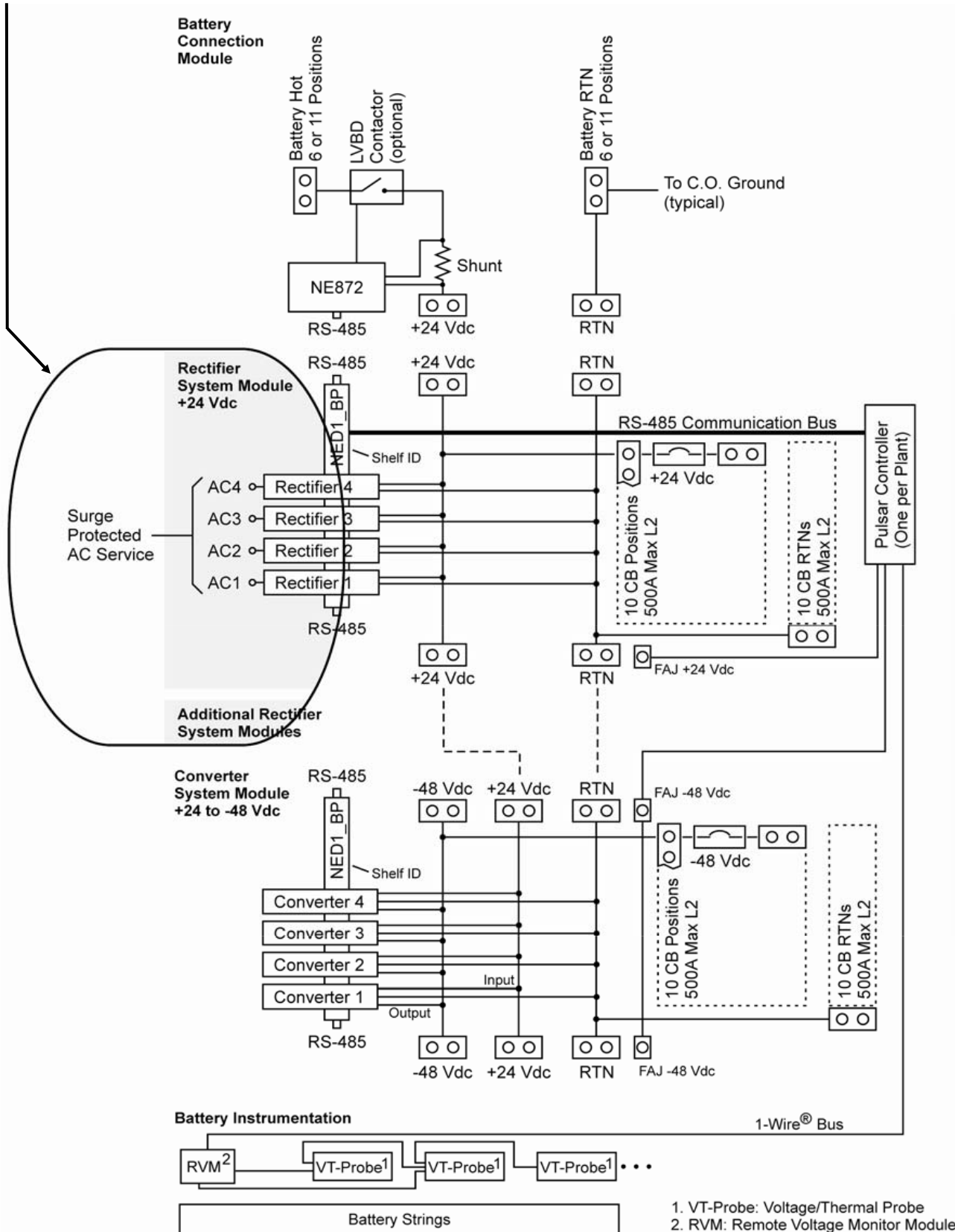

Connect ac Utility

Circled below is the part of the Block Diagram to be wired first.





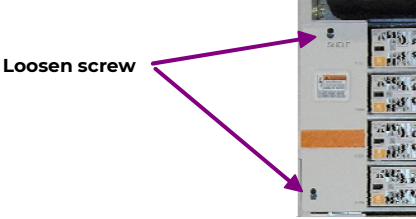











WARNING: Disconnect all ac branch circuits prior to making ac connections to the system. When connecting to utility source, ensure compliance to all local and national wiring rules .

There are only 2 options for AC wiring: Four 20A AC circuit breakers per shelf or two 40A AC circuit breakers per shelf .If you have 4 AC circuit breaker per shelf, one for each of the rectifier positions, start at step 1 here. If you have 2 AC circuit breakers per shelf, one AC circuit breaker for each pair of rectifiers, skip this procedure and go to the next procedure in this section.

Step	Action	
1.	Loosen the screws that secure the ACwiring cover.	 <p>Loosen screw</p>
2.	Remove the AC wiring cover.	
3.	Remove the conduit knockout.	
4.	At the AC service panel install a 20A double pole circuit breaker for each rectifier position. Choosethe breaker size according to code for the wire type and environmental conditions for your site. Use10 AWG wire for each rectifier.	
5.	Route two wires for each active rectifier position through 1 inch conduit and fitting, up to a total of8 active wires and one ground (PE), into the AC wiring compartment.	
6.	Terminate the PE (ground) wire to the chassis using a double hole lug (on 5/8 inchcenters) with a UL accepted crimp and tool.	 <p>Terminate Ground Wire</p>
		 <p>Illustration of wiring flow through conduit hole</p>
7.	Torque ground lug nuts to 65 inch-lbs or 7N·m using a 7/16 inch socket wrench.	
8.	Strip 0.32 inches (8 mm) of insulation off the end of each AC wire.	
9.	Examine the AC input terminal block provided in your shelf. Is the terminal block of single level configuration similar to that shown in the figure above?	

Step	Action																																																				
	<p>Yes, insert each wire into the bottom of the terminal block according to these diagrams:</p> <table border="1" data-bbox="289 348 755 474"> <thead> <tr> <th colspan="2">R1</th> <th colspan="2">R2</th> <th colspan="2">R3</th> <th colspan="2">R4</th> </tr> </thead> <tbody> <tr> <td>L1</td><td>L2</td> <td>L2</td><td>L3</td> <td>L3</td><td>L1</td> <td>L1</td><td>L2</td> </tr> </tbody> </table> <p>200-240Vac Wiring Diagram for 3 Wire +PE</p> <table border="1" data-bbox="310 558 743 684"> <thead> <tr> <th colspan="2">R1</th> <th colspan="2">R2</th> <th colspan="2">R3</th> <th colspan="2">R4</th> </tr> </thead> <tbody> <tr> <td>L1</td><td>N</td> <td>L2</td><td>N</td> <td>L3</td><td>N</td> <td>L1</td><td>N</td> </tr> </tbody> </table> <p>200-240Vac Wiring Diagram for 3 Wire +neutral +PE [NON-US ONLY]</p> <table border="1" data-bbox="289 800 755 926"> <thead> <tr> <th colspan="2">R1</th> <th colspan="2">R2</th> <th colspan="2">R3</th> <th colspan="2">R4</th> </tr> </thead> <tbody> <tr> <td>L1</td><td>L2</td> <td>L1</td><td>L2</td> <td>L1</td><td>L2</td> <td>L1</td><td>L2</td> </tr> </tbody> </table> <p>200-240Vac Wiring Diagram for 2 Wire +PE</p>	R1		R2		R3		R4		L1	L2	L2	L3	L3	L1	L1	L2	R1		R2		R3		R4		L1	N	L2	N	L3	N	L1	N	R1		R2		R3		R4		L1	L2	L1	L2	L1	L2	L1	L2				
R1		R2		R3		R4																																															
L1	L2	L2	L3	L3	L1	L1	L2																																														
R1		R2		R3		R4																																															
L1	N	L2	N	L3	N	L1	N																																														
R1		R2		R3		R4																																															
L1	L2	L1	L2	L1	L2	L1	L2																																														
	<p>No, the shelf has a tiered terminal block that can accept up to 8 AWG wires. Insert each feed wire into the bottom of the terminal block according to these diagrams:</p> <table border="1" data-bbox="881 394 1450 533"> <tbody> <tr> <td>R1</td><td>R2</td><td>R3</td><td>R4</td> </tr> <tr> <td>L1</td><td>L2</td><td>L3</td><td>L1</td> </tr> <tr> <td>R1</td><td>R2</td><td>R3</td><td>R4</td> </tr> <tr> <td>L2</td><td>L3</td><td>L1</td><td>L2</td> </tr> </tbody> </table> <p>200-240Vac Wiring Diagram for 3 Wire +PE</p> <table border="1" data-bbox="881 590 1450 737"> <tbody> <tr> <td>R1</td><td>R2</td><td>R3</td><td>R4</td> </tr> <tr> <td>L1</td><td>L2</td><td>L3</td><td>L1</td> </tr> <tr> <td>R1</td><td>R2</td><td>R3</td><td>R</td> </tr> <tr> <td>N</td><td>N</td><td>N</td><td>4</td> </tr> <tr> <td></td><td></td><td></td><td>N</td> </tr> </tbody> </table> <p>200-240Vac Wiring Diagram for 3 Wire + neutral +PE [NON-US ONLY]</p> <table border="1" data-bbox="886 810 1458 953"> <tbody> <tr> <td>R1</td><td>R2</td><td>R3</td><td>R4</td> </tr> <tr> <td>L1</td><td>L1</td><td>L1</td><td>L1</td> </tr> <tr> <td>R1</td><td>R2</td><td>R3</td><td>R4</td> </tr> <tr> <td>L2</td><td>L2</td><td>L2</td><td>L2</td> </tr> </tbody> </table> <p>200-240Vac Wiring Diagram for 2 Wire + PE</p>	R1	R2	R3	R4	L1	L2	L3	L1	R1	R2	R3	R4	L2	L3	L1	L2	R1	R2	R3	R4	L1	L2	L3	L1	R1	R2	R3	R	N	N	N	4				N	R1	R2	R3	R4	L1	L1	L1	L1	R1	R2	R3	R4	L2	L2	L2	L2
R1	R2	R3	R4																																																		
L1	L2	L3	L1																																																		
R1	R2	R3	R4																																																		
L2	L3	L1	L2																																																		
R1	R2	R3	R4																																																		
L1	L2	L3	L1																																																		
R1	R2	R3	R																																																		
N	N	N	4																																																		
			N																																																		
R1	R2	R3	R4																																																		
L1	L1	L1	L1																																																		
R1	R2	R3	R4																																																		
L2	L2	L2	L2																																																		
10.	Make sure all strands are captured in the appropriate wire clamp.																																																				
11.	Torque each wire clamp to 5-7 inch·lbs or 0.6-0.8 N·m.																																																				
12.	Secure conduit fitting.																																																				
13.	Replace AC Termination door.																																																				
14.	Tighten Screws to 5-7 inch·lbs or 0.6-0.8 N·m.																																																				

If you have one AC circuit breaker for each pair of rectifiers, start here.

Step	Action																									
1.	Loosen the screws that secure the AC wiring cover.																									
2.	Remove the AC wiring cover.																									
3.	Remove the conduit knockout.																									
4.	At the AC service panel install a 40A double pole circuit breaker for each pair of rectifiers. Use 8AWG wire.																									
5.	Route two 8 AWG wires for each pair of active rectifier positions through 1 inch conduit and fitting, and one 8AWG ground (PE), into the AC wiring compartment.																									
6.	Terminate the PE (ground) wire to the chassis using a double hole lug (on 5/8 inch centers) with a UL accepted crimp and tool.	 <p data-bbox="792 919 976 972">Terminate Ground Wire</p> <p data-bbox="813 1083 1062 1136">Illustration of wiring flow through conduit hole</p>																								
7.	Torque ground lug nuts to 65 inch-lbs or 7N·m using a 7/16 inch socket wrench.																									
8.	Break out the plastic dividers in 4 places as indicated in the diagram.	<table border="1" data-bbox="727 1272 1292 1402"> <tbody> <tr> <td>R1</td> <td></td> <td>R2</td> <td>R3</td> <td></td> <td>R4</td> </tr> <tr> <td>L1</td> <td></td> <td>L1</td> <td>L1</td> <td></td> <td>L1</td> </tr> <tr> <td>R1</td> <td></td> <td>R2</td> <td>R3</td> <td></td> <td>R4</td> </tr> <tr> <td>L2</td> <td></td> <td>L2</td> <td>L2</td> <td></td> <td>L2</td> </tr> </tbody> </table> <p data-bbox="813 1423 1203 1444">4 Locations where dividers are removed</p>  <p data-bbox="829 1587 951 1640">Snap Loose Plastic Divider With Pliers</p>	R1		R2	R3		R4	L1		L1	L1		L1	R1		R2	R3		R4	L2		L2	L2		L2
R1		R2	R3		R4																					
L1		L1	L1		L1																					
R1		R2	R3		R4																					
L2		L2	L2		L2																					

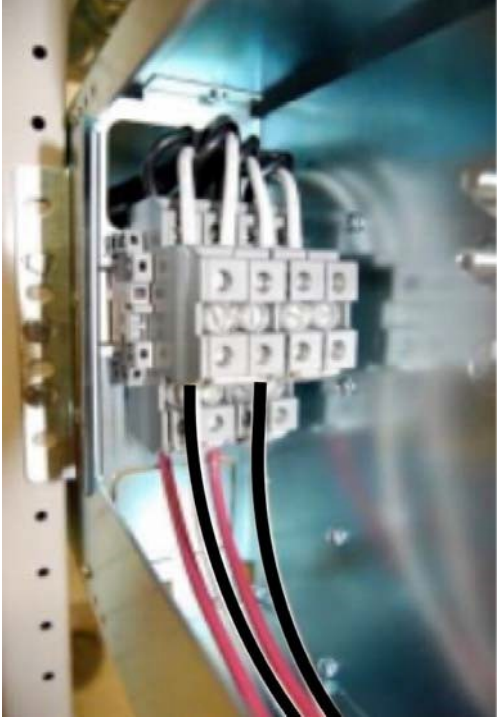
Step	Action									
9.	Insert the provided jumpers in the 4 locations where the dividers were removed.									
10.	Torque each of the 8 jumper retention screws to 10 inch-lbs or 1.1 N-m.									
11.	Insert each feed wire into the bottom of the terminal block according to this diagram. The jumper straps from the previous steps assure that rectifiers 2 and 4 are powered:	<table border="1" data-bbox="894 705 1471 867"> <tr> <td>R1 L1</td> <td>R2</td> <td>R3 L1</td> <td>R4</td> </tr> <tr> <td>R1 L2/European N</td> <td>R2</td> <td>R3 L2/ European N</td> <td>R4</td> </tr> </table> <p data-bbox="1000 877 1430 905">200-240Vac Wiring Diagram for 2 Wire + PE</p>  <p data-bbox="984 1644 1455 1671">Photo indicating positions 1 and 3 are powered .</p>	R1 L1	R2	R3 L1	R4	R1 L2/European N	R2	R3 L2/ European N	R4
R1 L1	R2	R3 L1	R4							
R1 L2/European N	R2	R3 L2/ European N	R4							
12.	Strip 0.32 inches (8 mm) of insulation off the end of each AC wire.									
13.	Make sure all strands are captured in the appropriate wire clamp.									
14.	Torque each wire clamp to 5-7 inch-lbs or 0.6-0.8 N-m.									
15.	Secure conduit fitting.									
16.	Replace AC Termination door.									
17.	Tighten Screws to 5-7 inch-lbs or 0.6-0.8 N-m.									

Wire the Battery Connection Module

Circled below is the part of the Block Diagram to be wired next.

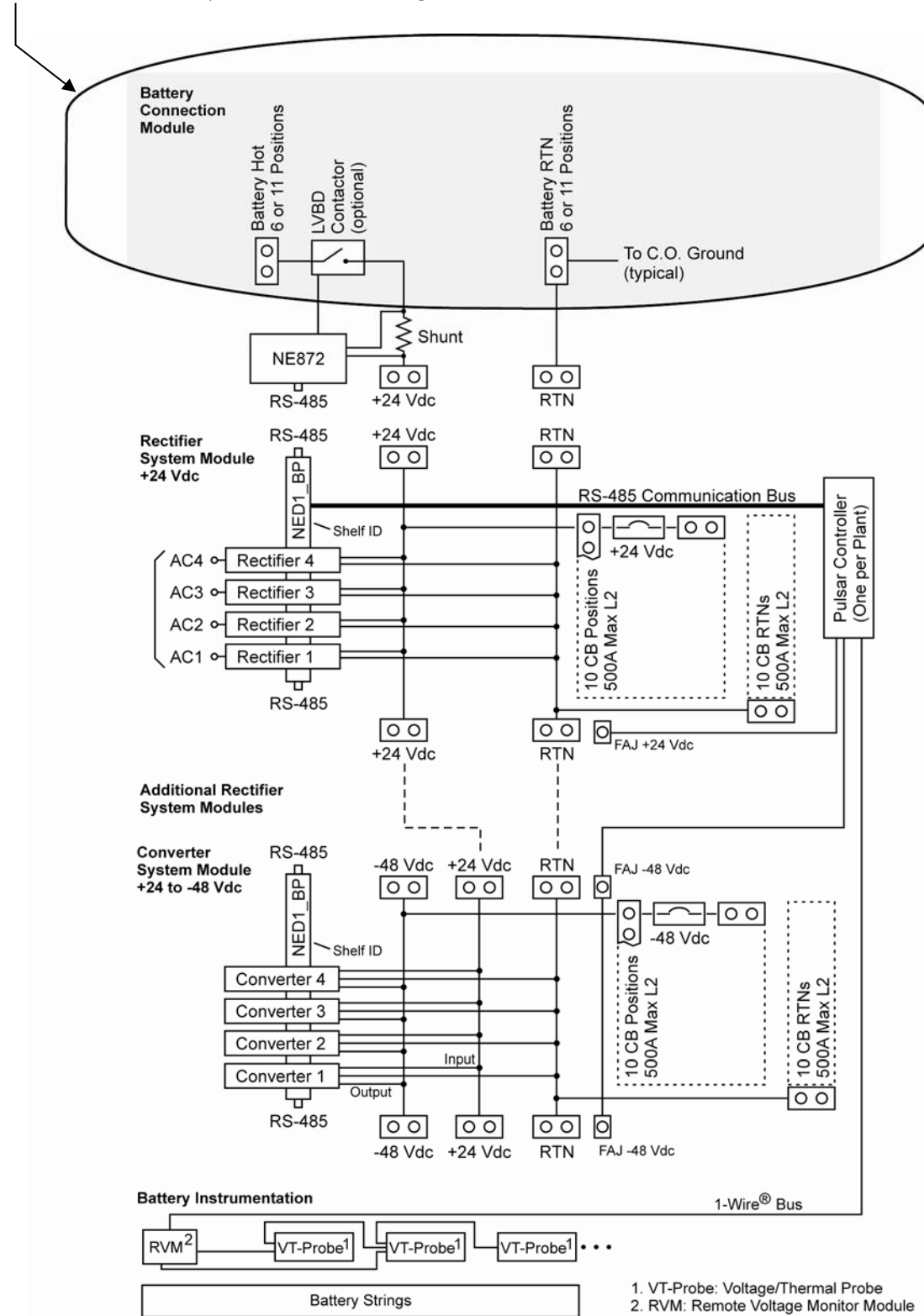

Connect Central Office Ground (COG)

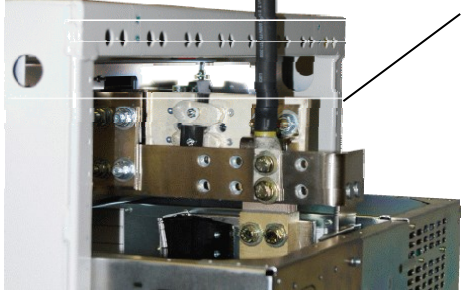
Step	Action	
<p>1.</p> <p>Locate CO Ground Termination Busbar for DC Return.</p> <p>Note: Landings are compatible with lugs with 1" hole spacing for 3/8" hardware.</p>		<p style="text-align: center;">CO Return Ground Termination Busbar</p> 
<p>2.</p> <p>Secure Central Office Ground connection. Use:</p> <ul style="list-style-type: none"> (2) 801273129 3/8-16 x 1in bolt (2) 801829607 3/8-inch lock washer (2) 802841635 3/8-inch flat washer <p>If required by local code or practice, treat with an oxidation inhibitor such as NO-OX.</p>		
<p>3.</p>	<p>Use 9/16" socket. Torque to 240 in·lbs (27Nm)</p>	

Connect External Battery Cables

Battery Cable landings are located at the top of the frame. The return is on your right and the hot or +24 side is on your left. The extra plastic insulators around the battery bus bars on the left confirm that this is the electrically hot side with respect to earth.

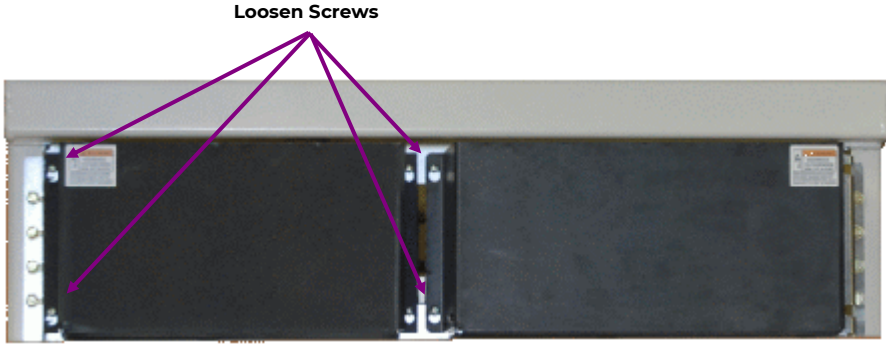
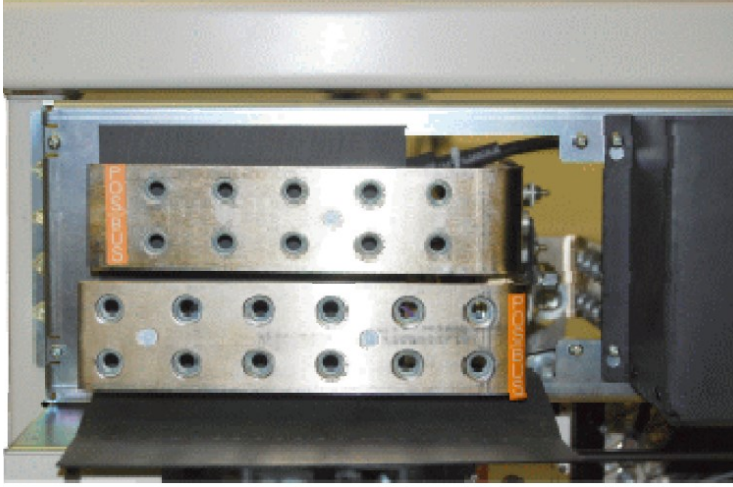
Step	Action
<p>1.</p>	<p>Loosen the four screws that secure the Battery Hot Termination cover located on the left side of the Battery Connection Module.</p> <div data-bbox="391 598 1271 940" data-label="Image">  <p>The image shows a close-up of the Battery Connection Module. A black cover is attached to the left side of the module. Four screws are visible, securing the cover. Purple arrows point to these screws, with the text 'Loosen Screws' above them.</p> </div>
<p>2.</p>	<p>Lift off the Battery Hot Termination Cover to reveal the +24V Battery lead termination bus bar.</p> <div data-bbox="461 1094 1190 1577" data-label="Image">  <p>The image shows the Battery Connection Module with the black cover removed. Two metal bus bars are visible, each with four circular terminals. The top bus bar is labeled '+24V' and the bottom bus bar is labeled 'RETURN'. The bus bars are mounted on a metal frame.</p> </div>

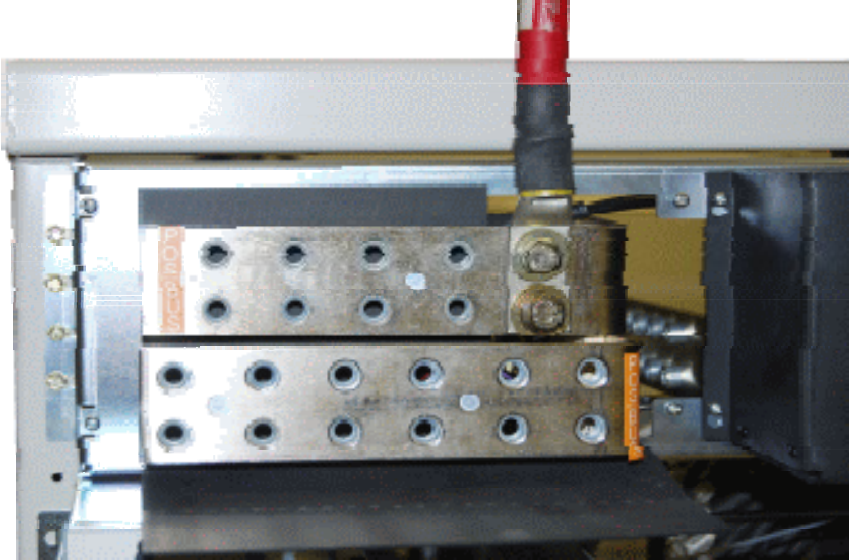
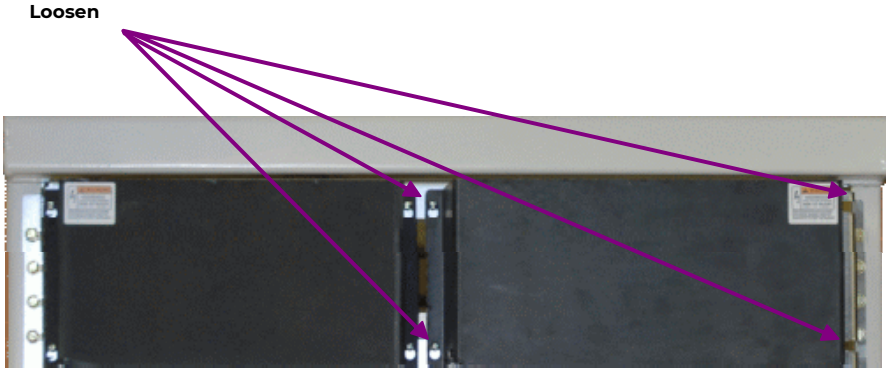
Step	Action
3.	<p>Secure the Hot Lead for each battery string, starting from the middle of the bay and working to the outside. Use a double hole lug with holes on 1 inch centers.</p>  <p>Hardware list for each termination is: (2) 801273129 3/8-16 x 1in bolt (2) 801829607 3/8-inch lock washer (2) 802841635 3/8-inch flat washer</p> <p>If required by local code or practice, treat with an oxidation inhibitor such as NO-OX. Note: Landings are compatible with lugs with 1" hole spacing for 3/8" hardware.</p>
4.	Use 9/16" socket. Torque each bolt to 240 in·lbs or 27Nm
5.	Replace Cover
6.	Re-torque screws to ~6 in·lbs (0.5 Nm)
7.	<p>Loosen the four screws that secure the Return Termination cover located on the right side of the Battery Connection Module.</p> 

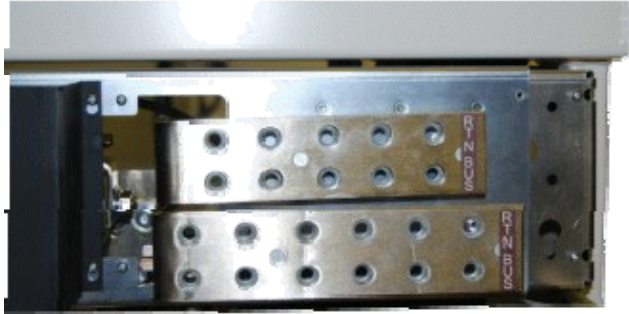
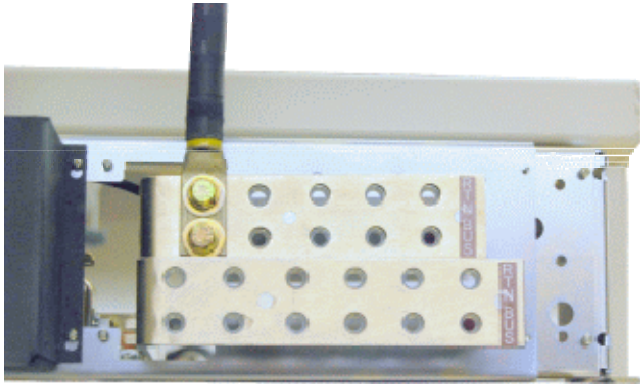
Step	Action
8.	<p>Lift off the Return Termination Cover to reveal the Battery Return lead termination bus bar.</p> 
9.	<p>Secure the Return Lead for each battery string. Use the back bus bar, starting toward the middle of the bay and working to the outside. Use a double hole lug with holes on 1 inch centers.</p>  <p>Hardware list for each termination is:</p> <ul style="list-style-type: none"> (2) 801273129 3/8-16 x 1in bolt (2) 801829607 3/8-inch lockwasher (2) 802841635 3/8-inch flatwasher <p>If required by local code or practice, treat with an oxidation inhibitor such as NO-OX. Note: Landings are compatible with lugs with 1" hole spacing for 3/8" hardware.</p>
10.	Use 9/16" socket. Torque each bolt to 240 in·lbs or 27Nm
11.	Replace Cover

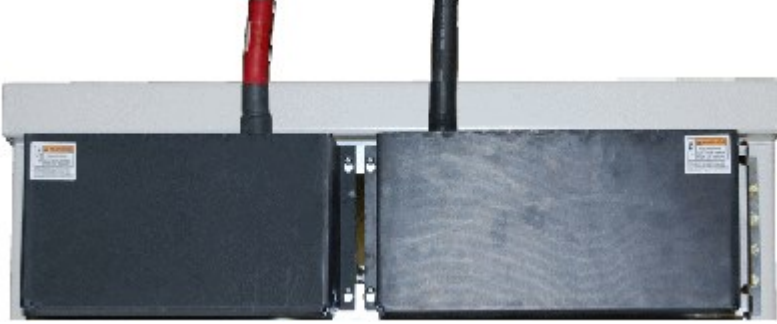
Step	Action
12.	<p data-bbox="220 285 669 317">Re-torque screws to ~6 in·lbs(0.5 Nm)</p> <div data-bbox="435 359 1208 680"></div> <p data-bbox="581 726 1052 789" style="text-align: center;">Battery Connection Module (terminated with 1 representative battery string)</p>

Wire +24V DC Loads

Circled below is the +24V Load Wiring part of the Block Diagram wired next.

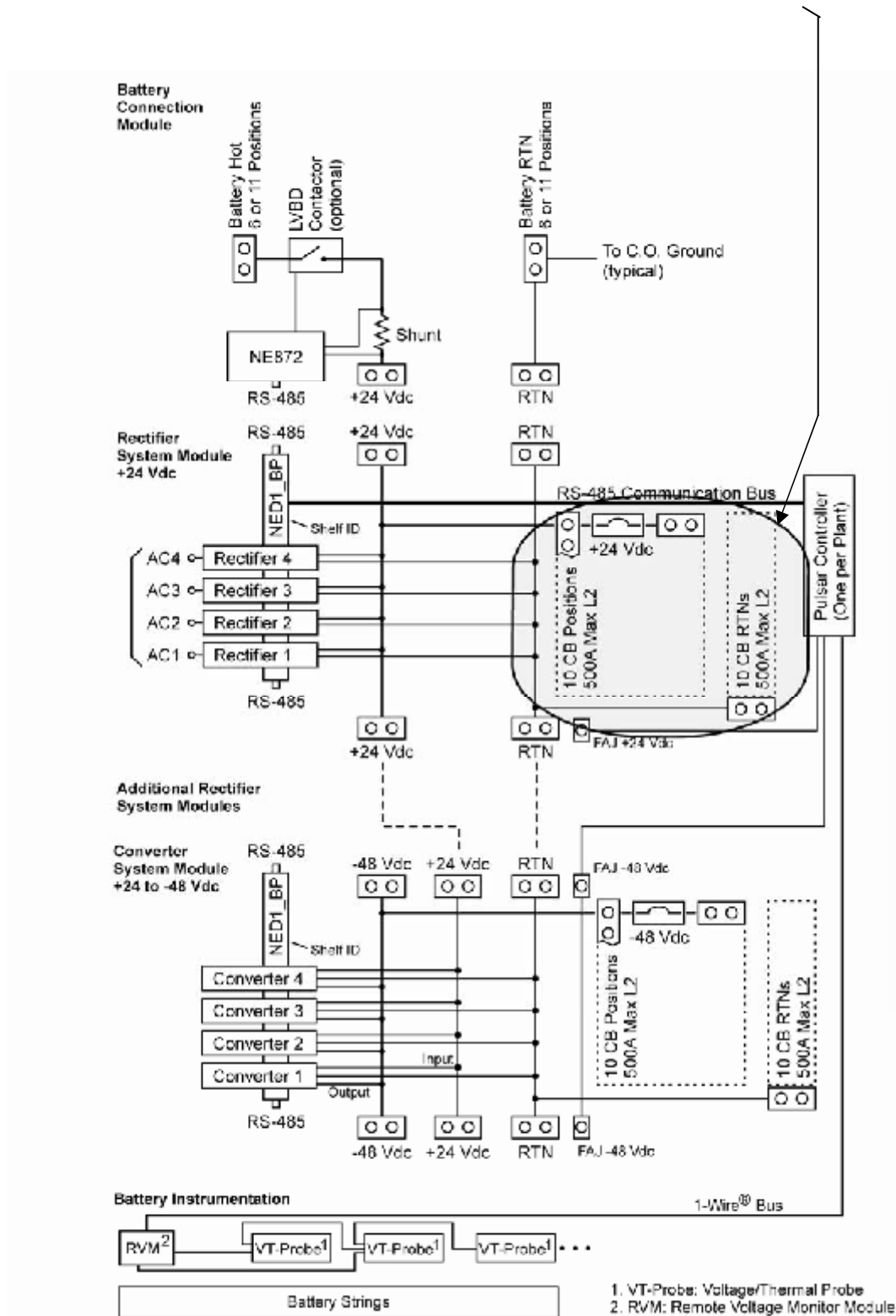

Install dc Bullet Style Circuit Breaker Modules for +24V Loads

This plant makes use of a [circuit breaker]/[lug landing] assembly for each normal format bullet style circuit breaker. This section illustrates how these are installed.

CAUTION: Ensure Circuit Breakers are in the OFF position prior to installation.

CAUTION: In order to meet UL Listing temperature limits in the event of overload, high current rated Bullet Breaker locations must meet all of these layout restrictions:

- Maximum rating of 1-pole breakers is 70A.
- Maximum rating of 2-pole breakers is 100A.
- Maximum grouping of 250 A before skipping a circuit breaker position.

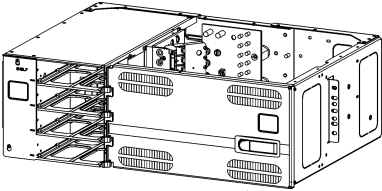
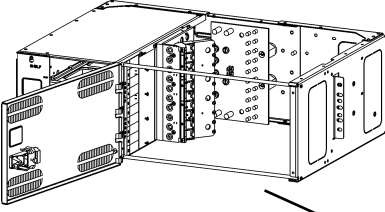
Step	Action	Action
<p>1.</p>	<p>Open the Rectifier System Module door</p>	 <p>Open door by pressing here</p>
<p>2.</p>	<p>Locate Circuit Breaker (CB) mounting panel.</p>	 <p>Locate CB mounting panel</p>

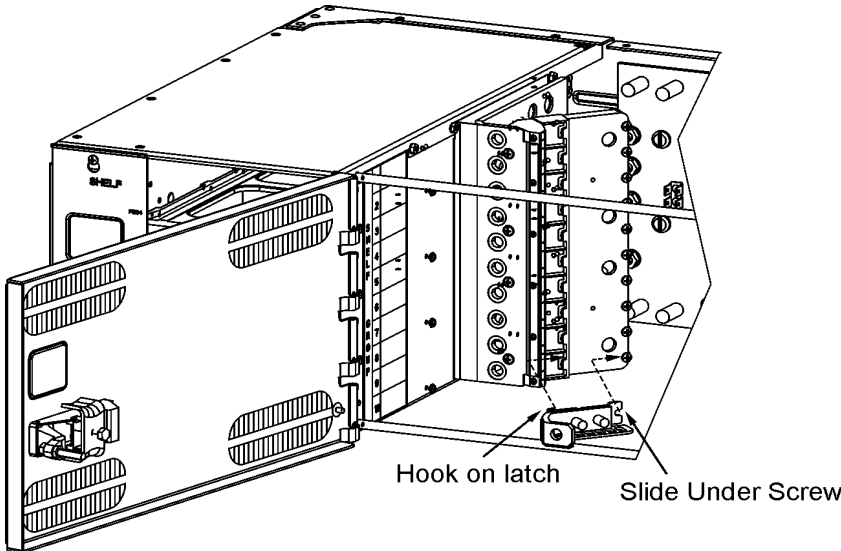
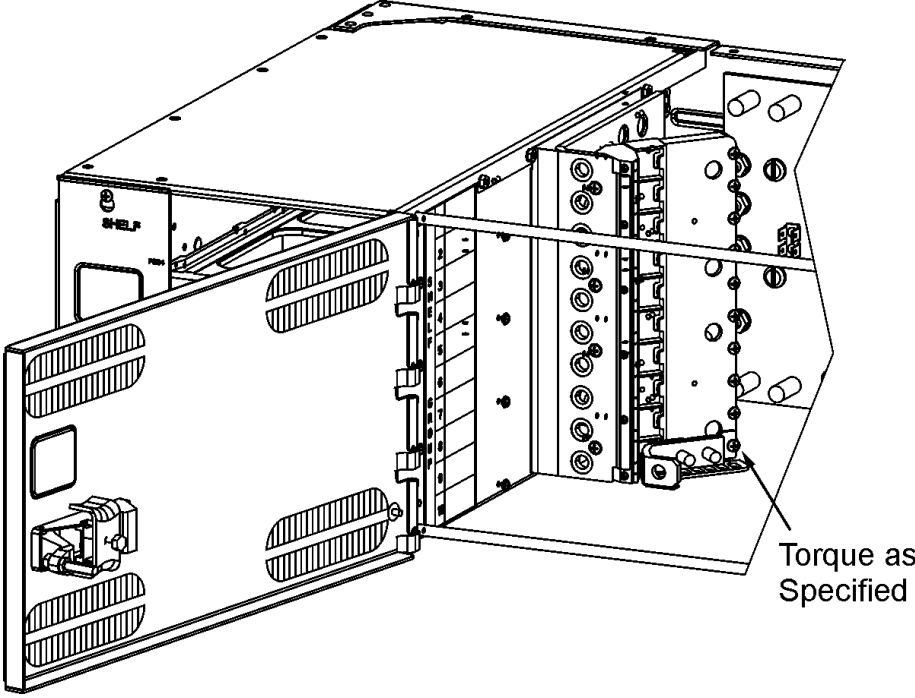
Step	Action
<p>3.</p>	<p>Insert a Circuit Breaker Termination module starting in the lowest position:</p>  <p>Hook on latch Slide Under Screw</p>
<p>4.</p>	<p>Torque to 4 in lbs:</p>  <p>Torque as Specified</p>

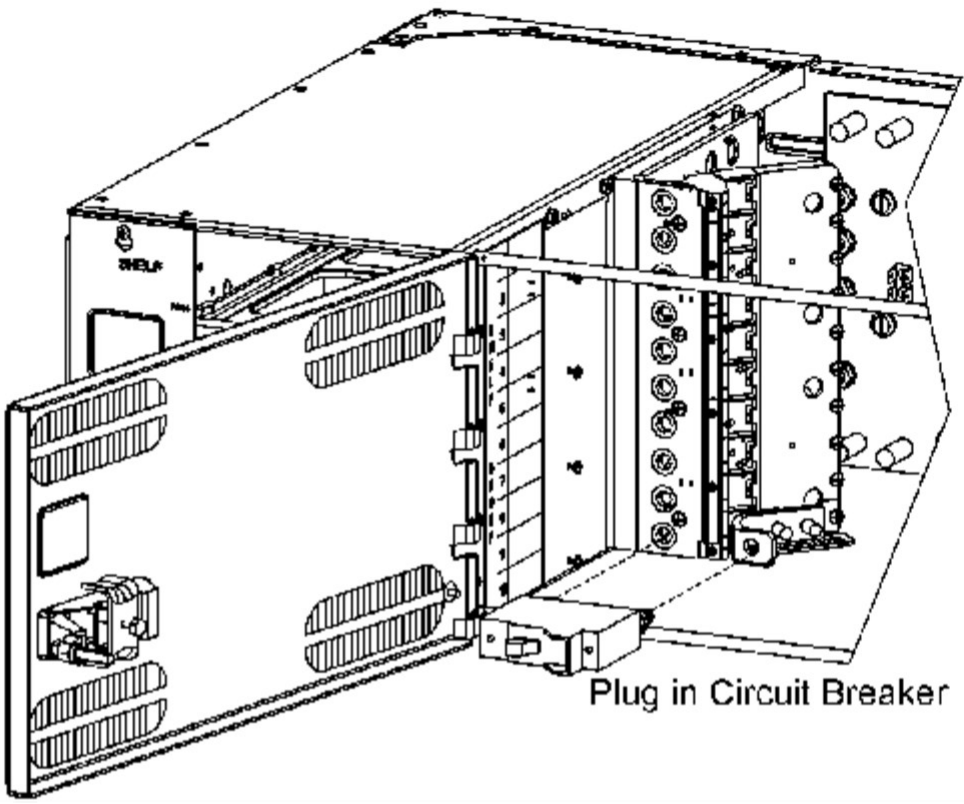
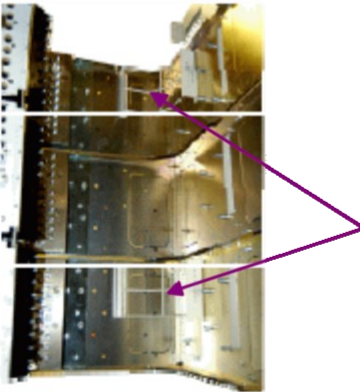
Step	Action
5.	<p>Plug in Circuit Breaker:</p> 
6.	Mark the label to the left of the circuit breaker according to standard practice in your network.
7.	Feed a wire pair from the top of the bay down to the desired location.
8.	<p>Locate and dress the pair to tie bars in the right back corner of the DC wiring area:</p> 
9.	Terminate the feeding lead on the circuit breaker lug landing using the hardware provided.
10.	Terminate the return on the return bus located on the back wall of the distribution area using the hardware provided.

Step	Action
11.	Torque all fasteners to 65 in lbs (7 Nm) using an insulated extension at least 5 inches long.
Two-Pole and Three-Pole Breakers:	
12.	Secure Two-Pole and Three-Pole Circuit Breaker and Lug Landing Assemblies in the same fashion.
13.	Mark the label to the left of the circuit breaker according to standard practice in your network.
14.	Feed a wire pair from the top of the bay down to the desired location.
15.	Locate and dress the pair to tie bars in the right back corner of the DC wiring area.
16.	Terminate the send using a suitable lug with 5/16 inch holes on 1 inch centers using hardware provided.
17.	Torque the send lug nuts to 130 in-lbs (15 Nm) using a ½ inch socket.
18.	Terminate the Return using a suitable lug with 1/4 inch holes on 5/8 inch centers using hardware provided.
19.	Torque the Return lug nuts to 65 in-lbs (7 Nm).
20.	Returns for 4/0 cable should be terminated to the CO Ground bar in the Battery Termination Module.

Wire -48V DC Loads

Circled below is the -48V Load Wiring part of the Block Diagram wired next.

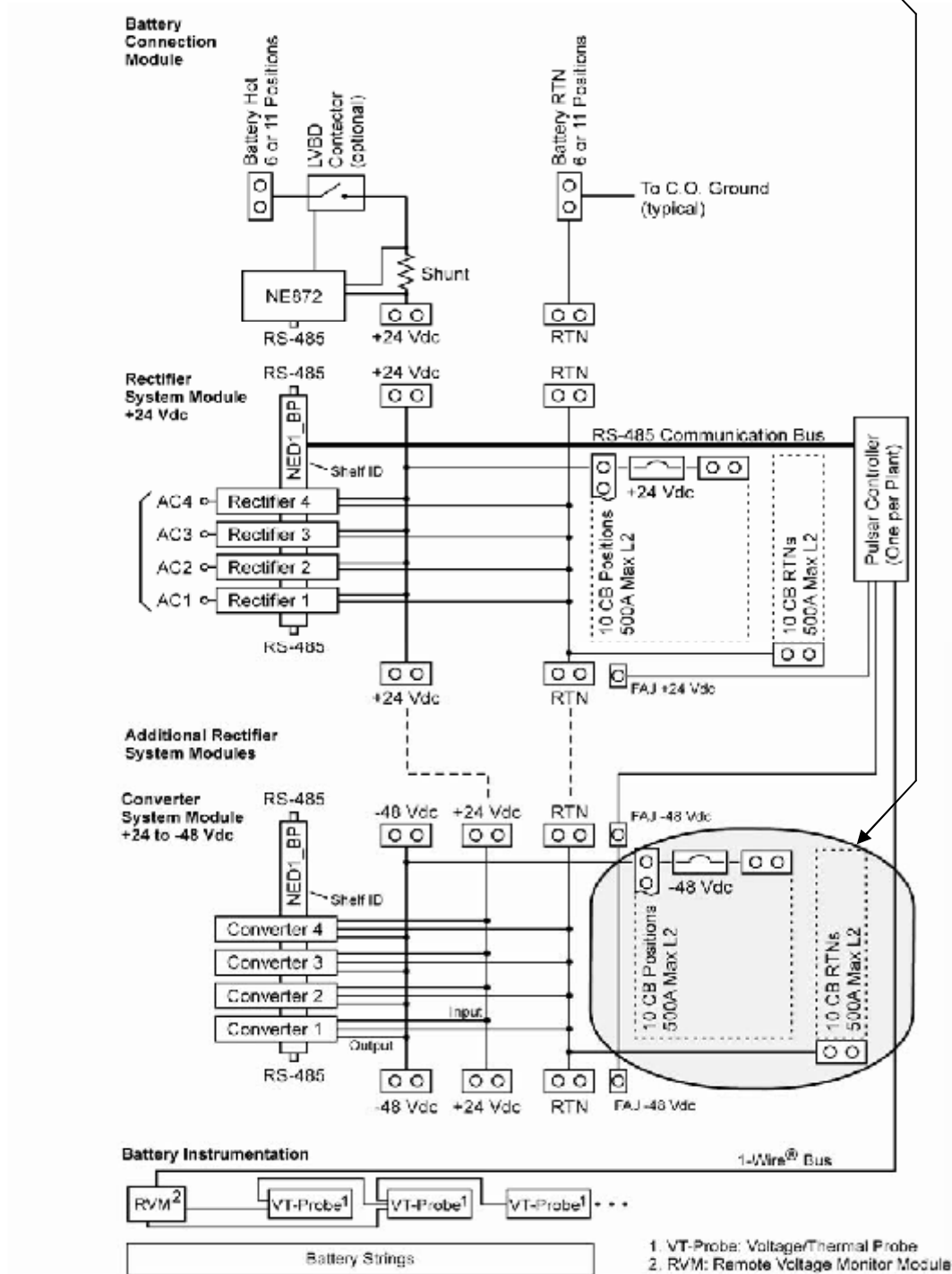

Install dc Bullet Style Circuit Breaker Modules for -48V Loads

This plant makes use of a [circuit breaker]/[lug landing] assembly for each normal format bullet style circuit breaker. This section illustrates how these are installed.



CAUTION: Ensure Circuit Breakers are in the OFF position prior to installation.

CAUTION: In order to meet UL Listing temperature limits in the event of overload, high current rated Bullet Breaker locations must meet all of these layout restrictions:

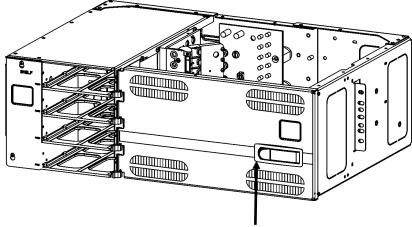
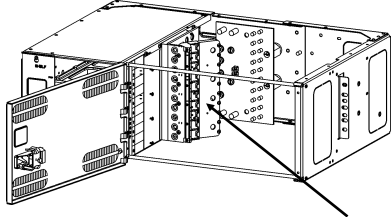
- Maximum rating of 1-pole breakers is 70A.
- Maximum rating of 2-pole breakers is 100A.
- Maximum grouping of 250 A before skipping a circuit breaker position.

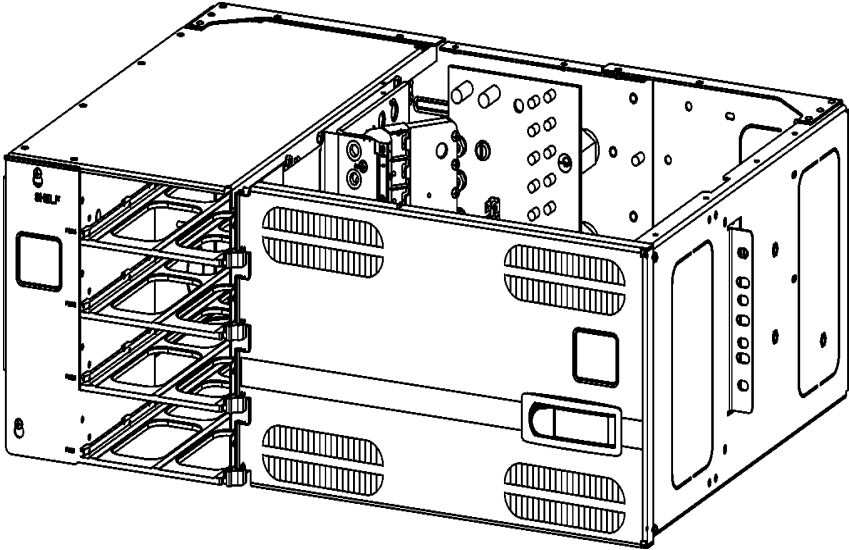
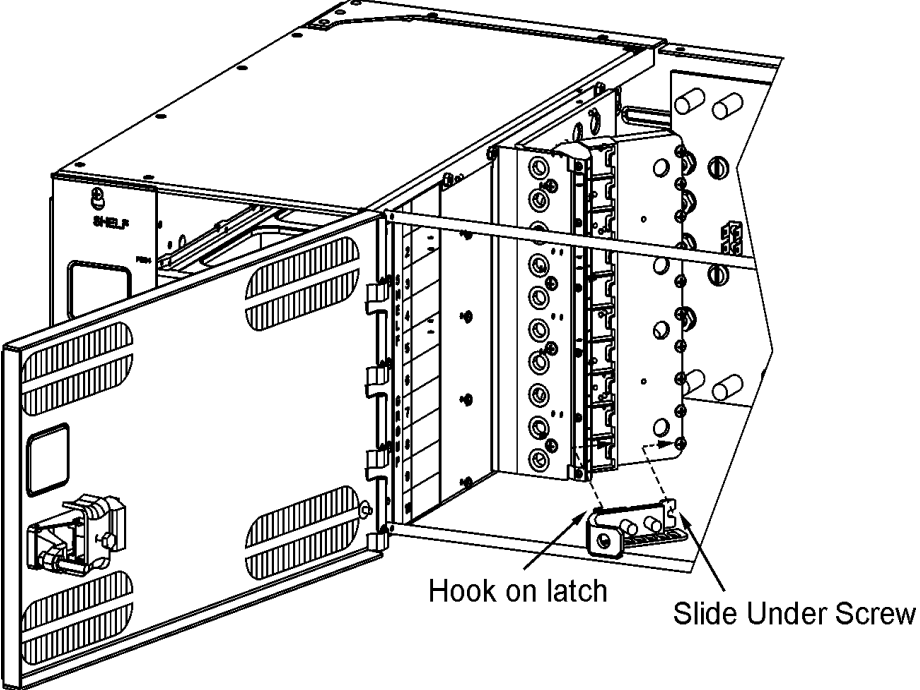
Step	Action	Action
1.	Open the Converter System Module door	 <p data-bbox="997 989 1271 1014">Open door by pressing here</p>
2.	Locate Circuit Breaker (CB) mounting panel.	

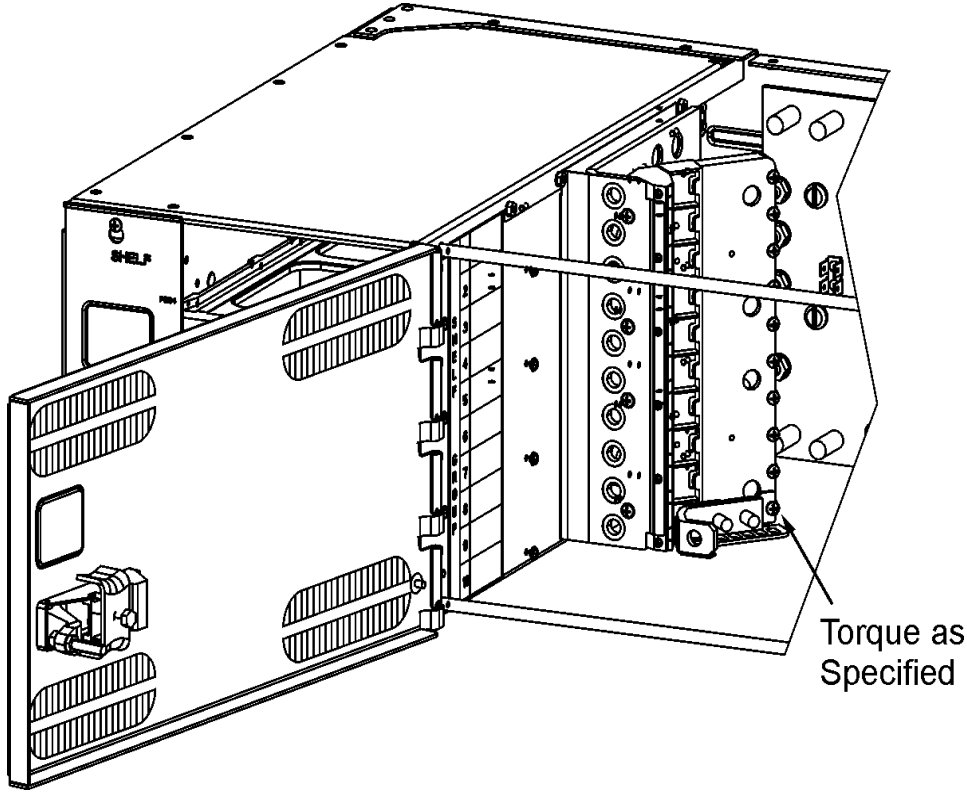
Step	Action
3.	<p>Insert a Circuit Breaker Termination module starting in the lowest position:</p> 
4.	<p>Torque to 4 in lbs:</p> 

Step	Action
<p>5.</p>	<p>Plug in Circuit Breaker:</p> 
<p>6.</p>	<p>Mark the label to the left of the circuit breaker according to standard practice in your network.</p>
<p>7.</p>	<p>Feed a wire pair from the top of the bay down to the desired location.</p>
<p>8.</p>	<p>Locate and dress the pair to tie bars in the right back corner of the DC wiring area:</p> 
<p>9.</p>	<p>Terminate the send on the circuit breaker lug landing using the hardware provided.</p>
<p>10.</p>	<p>Terminate the return on the return bus located on the back wall of the distribution area using the hardware provided.</p>
<p>11.</p>	<p>Torque all fasteners to 65 in·lbs (7 Nm) using an insulated extension at least 5 inches long.</p>

Step	Action
Two-Pole and Three-Pole Breakers:	
12.	Secure Two-Pole and Three-Pole Circuit Breaker and Lug Landing Assemblies in the same fashion.
13.	Mark the label to the left of the circuit breaker according to standard practice in your network.
14.	Feed a wire pair from the top of the bay down to the desired location.
15.	Locate and dress the pair to tie bars in the right back corner of the DC wiring area.
16.	Terminate the send using a suitable lug with 5/16 inch holes on 1 inch centers using hardware provided.
17.	Torque the send lug nuts to 130 in-lbs (15 Nm) using a ½ inch socket.
18.	Terminate the Return using a suitable lug with 1/4 inch holes on 5/8 inch centers using hardware provided.
19.	Torque the Return lug nuts to 65 in-lbs (7 Nm).
20.	Returns for 4/0 cable should be terminated to the CO Ground bar in the Battery Termination module.

Wire Loads served by GMT Type Fuses

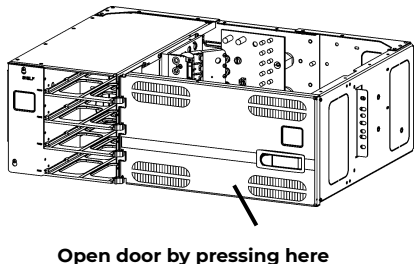
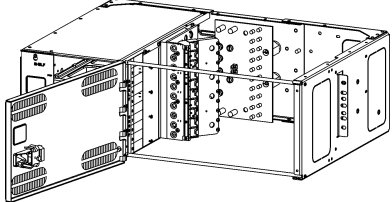
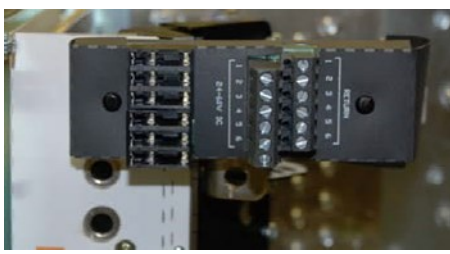
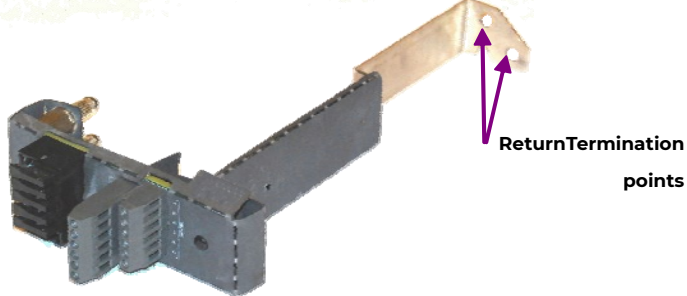
Step	Action	Action
1.	Open the Converter or Rectifier System Module door	 <p>Open door by pressing here</p>
2.	Locate Circuit Breaker (CB) mounting Panel.	
3.	Install a 6 position GMT type fuse holder in 2 Circuit Breaker distribution positions (see picture)	
4.	Terminate the return busbar according to the instructions provided with the GMT fuse holder kit.	 <p>Return Termination points</p>
5.	Complete installation and wiring according to the instructions provided with the kit.	

Verify Previous Installation Steps

Perform the following verification checklist after installation of batteries and wiring:



Step	Action
1.	Verify cabinet is properly grounded (using Digital Multimeter (DMM)).
2.	Verify the ac equipment ground is properly connected.
3.	Verify the correct ground cable gauge is used. Use the standard grounding principles for your office.
4.	Verify the ac voltage supplied matches the ac input voltage of the rectifiers.
5.	Verify all cables are properly installed for the distribution and marked with labels to identify them as 48 volt or 24 volt circuits.
6.	Examine to assure no sharp corners are in contact with dressed wires. Modify to correct any problems found.
7.	Check for conductor clearance within the bay associated with high power.
8.	Check that all breakers are off and all fuses not inserted.
9.	Verify the battery contactors are open, if equipped. Manually operate them to the open position, if necessary, by pushing the contacts apart.
10.	Verify the polarity of all battery cables (using DMM).
11.	Verify no shorts are present between frame ground and the ac service. Measure resistance from each ac input line terminal block position to frame ground.
12.	Verify shelves and rectifier positions are properly identified. Label positions as necessary.
13.	Verify battery negative cables are connected to the appropriate bus bar.
14.	Verify battery positive cables are connected to the appropriate bus bar.
15.	Visually verify the RS485 cables are properly installed and that shelf ID settings at the rear of the frame are: [Shelf 1, Shelf 2, Shelf 3, etc.] from top to bottom.

Install Rectifiers and Converters

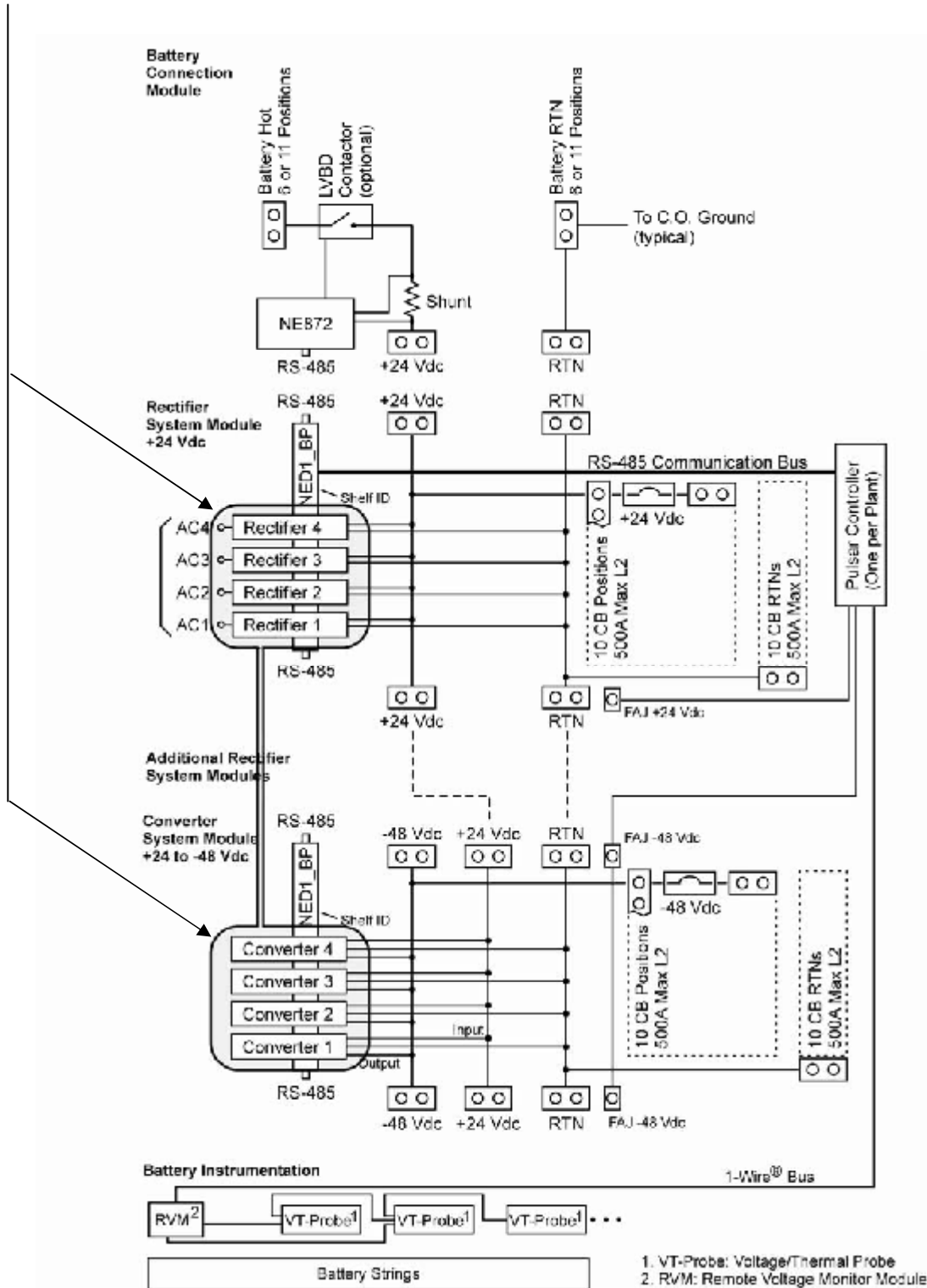

Circled here are the Rectifier and Converter Installation parts of the Block Diagram.

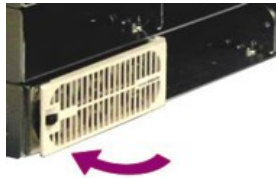

Rectifier/Converter Installation Procedure

Step	Action	
1.	Slide the rectifier/converter partially into as lot.	
2.	Open the faceplate by sliding the black latch to the left to release the faceplate.	
3.	Push the unit firmly into the shelf until seated.	
	Using optional air filter?	
	Yes – Proceed to Step 4.	No – Go to Step 5.
4.	Install an air filter by placing it inside the faceplate.	
5.	Swing the faceplate closed until it is secured by the latch.	
6.	After 30 seconds, verify green LED and only green LED is on. If this isn't the case, see the Troubleshooting section.	

Rectifier/Converter Removal Procedure

Step	Action	
1.	Open the faceplate to disengage the rectifier/converter.	
2.	Remove the unit from the shelf.	

Use the above rectifier installation procedure as needed in the following steps.

Note: You will be directed to use the Menu commands from the front of the Pulsar Controller.

Step	Action
1.	Turn on ac service circuit breakers to apply power to the system rectifier positions.
2.	Install a rectifier in an available rectifier position.
3.	Wait until the rectifier establishes communications with the controller (the red Fail LED stops flashing).
4.	Verify green Norm LED is lit.
5.	Apply 10 amperes of load to the system.
6.	Verify (if equipped) the contactor closes and connects the battery strings.
7.	If an audible alarm is present, press the ENTER key to MUTE the audible alarm. Check all connections. If the alarm does not clear go to the troubleshooting section.
8.	Verify all LEDs are green on the controller and the display is visible with the proper voltage shown.
9.	Increase the system load current to 20 amperes.
10.	Install rectifier in the next position.
11.	Wait until the rectifier establishes communications with the controller (the red Fail LED stops flashing).
12.	Verify green Norm LED is lit.
13.	Verify the two rectifiers are present and verify the rectifier output currents by using the front panel: MENU > STATUS > RECTIFIERS > RECTIFIER CURRENTS.
14.	Increase the system load current to 50 amperes.
15.	Continue to add rectifiers as required.
16.	Verify the rectifiers share the load and the voltage regulation is correct. Rectifiers should load share after 2 minutes to within 5% of the total average output.
17.	Verify front panel display voltage is within 0.5% of the Float Setpoint.
18.	Remove a rectifier and ignore the request to remove missing equipment.
19.	Verify the controller identifies the rectifier as missing to verify that the Minor Communication Fail alarm is operational.
20.	Re-install the rectifier and verify that the alarm clears.

Repeat the above steps for converters in the Converter System Module.

For more information on the Infinity D Rectifiers and Converters, see the Troubleshooting section.

Install Battery Instrumentation

Circled here are the Battery Instrumentation Installation parts of the Block Diagram.

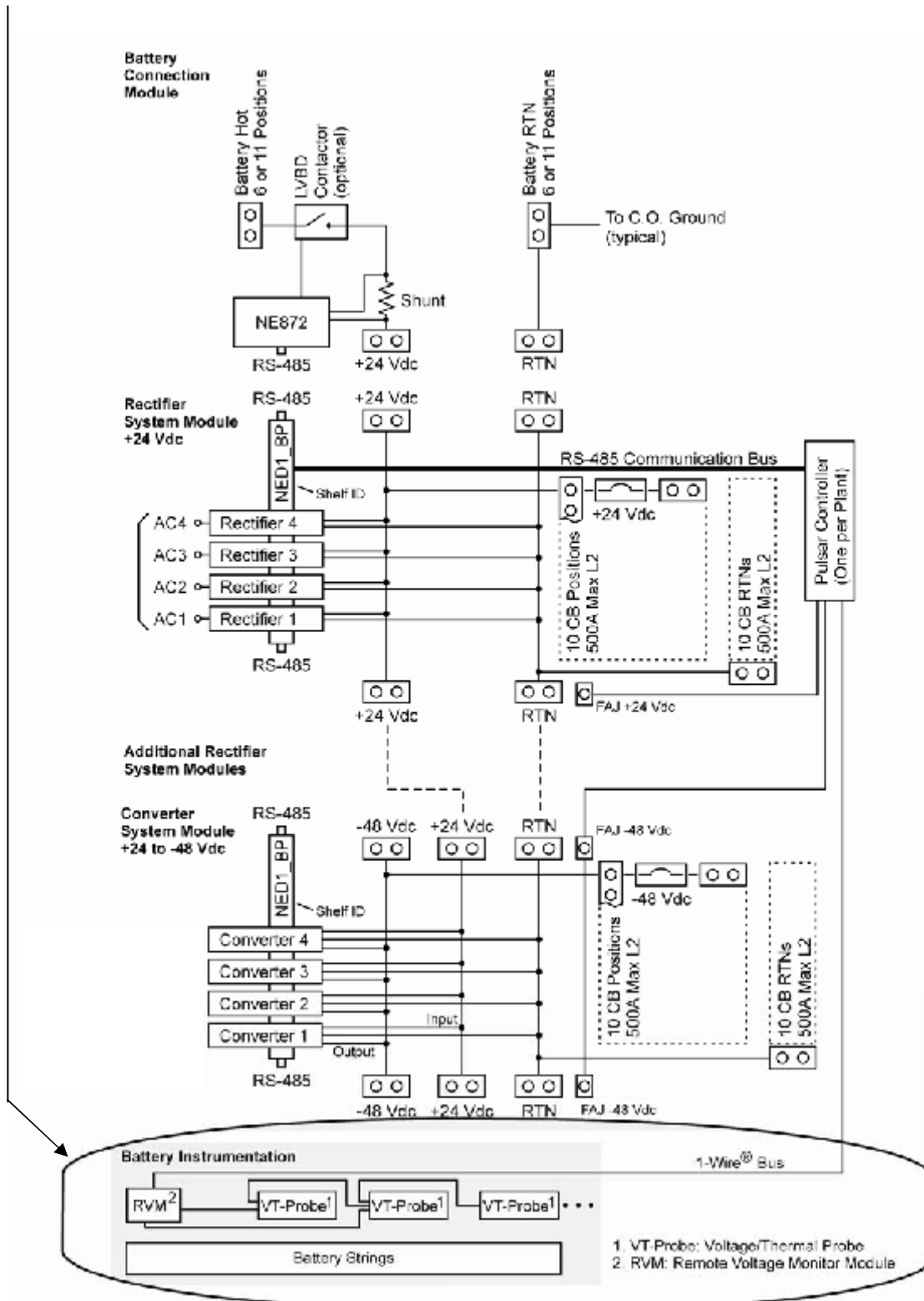

Install Battery VT Probes

Install Battery VT Probes without Voltage Monitoring

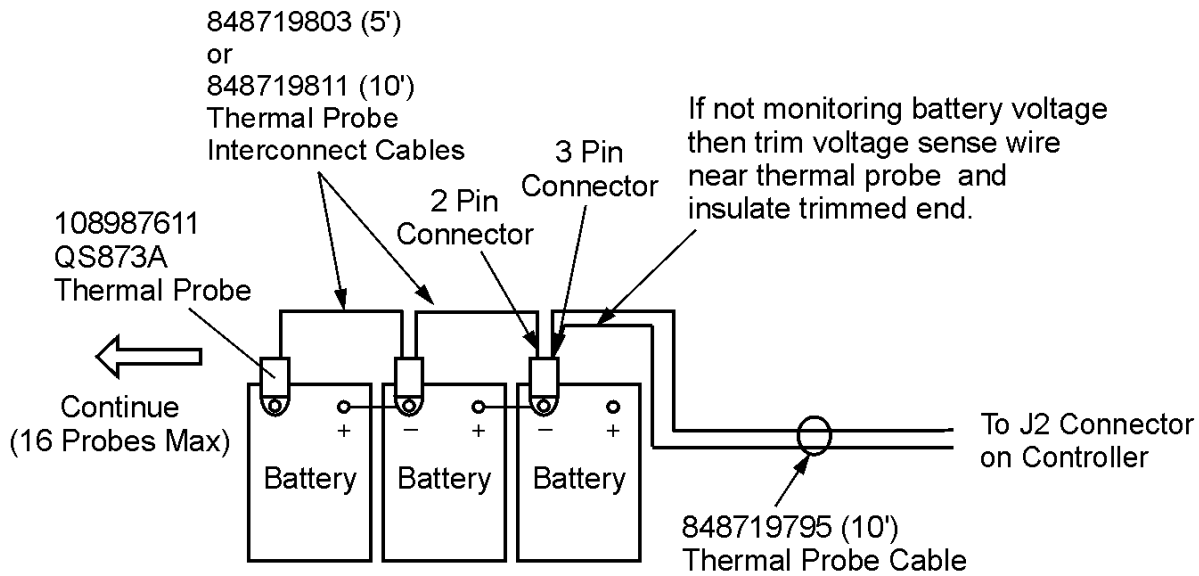

Note: 848719795, 848719803 and 848719811 all come with a discrete wire for Battery Voltage Sense. If not used, then trim and insulate trimmed end.

The QS873A weatherized VT-Probe is provided with 2-pin and 3-pin receptacles and a 1/4-inch ring terminal.

VT-Probe Connections to Controller Connection (Lead Acid)

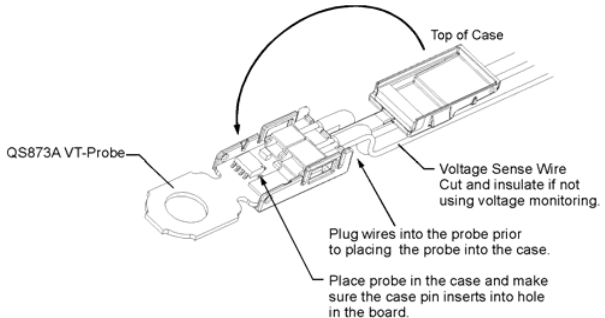
Step	Action
1.	Insert the RJ-45 end of the 848719795 wireset into the Temp Connector on the controller. <p style="text-align: center;">Open door by pressing here</p> 
Using Voltage monitoring ?	
Yes – Proceed to Step 2.	No – Go to Step 3.
2. 3.	Cut the brown voltage sense wire on the 848719795 at the 3-pin connector. Insert the 3-pin connector end into the receptacle on the closest VT- Probe. <div style="text-align: right; margin-top: 20px;">  </div>
4.	Snap the cover closed on the VT-probe.

Step	Action
5.	Place the first probe to the battery post (as in the picture in Step 3). Note: Probes are typically installed one per string, located in the center of the string.
6.	Verify the number of probes (1) registered with the controller with command: MENU > STATUS > BATTERIES > TEMP PROBES PRESENT.
7.	Connect either the 848719803 (5-ft) or the 848719811 (10-ft) cable to the 2-position receptacle of the first probe and to the 3-position receptacle of another probe.
8.	Verify the number of probes (2) registered with the controller with command: MENU > STATUS > BATTERIES > TEMP PROBES PRESENT.
9.	Repeat Steps 7-8 for each probe until all probes are installed.
10.	When all probes are installed, verify they are connected and operating with command: MENU > STATUS > BATTERIES > TEMP PROBES PRESENT.

The controller is now ready to take thermal measurements in performing slope thermal compensation and battery high temperature disconnect. Additional parameters may be set on the controller to customize this feature.

Install Battery VT Probes with Voltage Monitoring

The figure below shows the interconnection of the maximum number of VT-Probes for both voltage monitoring and thermal compensation.

All 16 batteries are shown as being monitored for thermal compensation and all four strings are being monitored for voltage imbalance by the probes in the middle batteries of all strings.

If your actual interconnection only requires monitoring one battery in each string, the middle battery in each string should be used when both the voltage imbalance and thermal compensation features are desired.

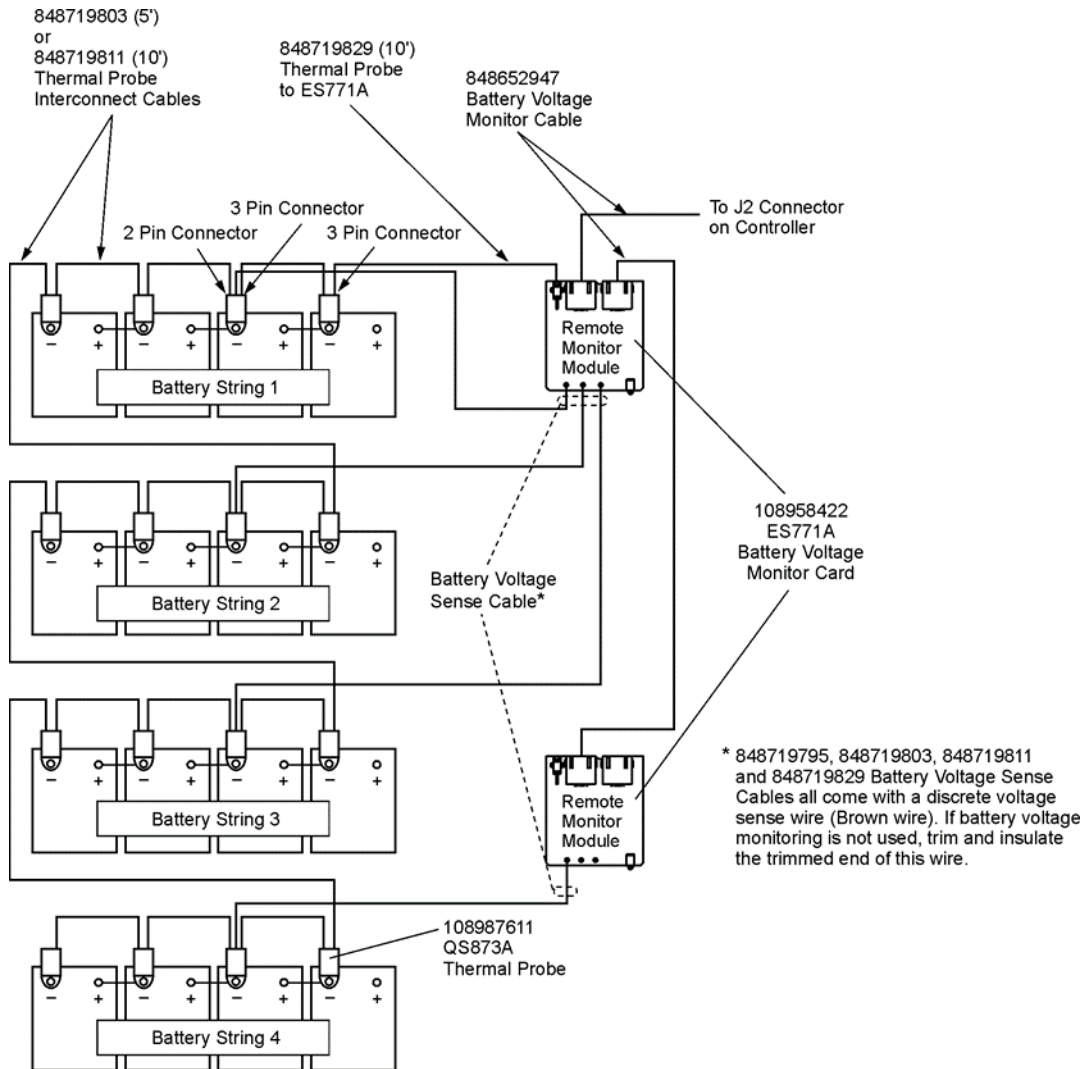

VT-Probe/Battery Voltage Monitor Connections to Controller (Optional)

Step	Action
1.	Insert one RJ-45 end of the 848652947 wireset into the J2 Connector on the controller and the other end to the first ES771A Remote Voltage Monitor module. Set address switch to 01.
2.	Verify the number of modules (1) registered with the controller with command: MENU > STATUS > BATTERIES > NUM MIDPT MODULES.
3.	If required, connect another ES771A by connecting an additional 848652947 wireset into RJ-45 receptacles on both modules. Set unique address to 02.
4.	Verify the number of modules (2) registered with the controller with command: MENU > STATUS > BATTERIES > NUM MIDPT MODULES.
5.	Repeat Steps 3-4 until all required ES771A modules are installed.
6.	When all modules are installed, verify they are connected and operating with command: MENU > STATUS > BATTERIES > NUM MIDPT MODULES.

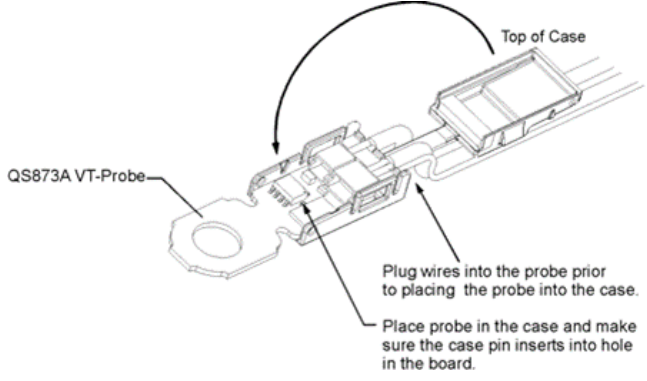
Step	Action
	Are the LEDs on the module(s) on (and not red) and are the number of registered modules the same as the number used?
	Yes – Go to Step 9. No – Proceed to Step 7.
7.	Check integrity of all cable connections.
8.	Issue the Clear Events command: MENU > CONTROL / OPERATIONS > CLEAR EVENTS. (If the LEDs are still not lit green or if the number of registered modules still does not agree, call your local field representative.)
9.	Connect the 848719829 (10-ft) cable to the 3-pin receptacle of the first ES771A and to the 3-pin receptacle of the first probe.
10.	Verify the number of probes (1) registered with the controller with command: MENU > STATUS > BATTERIES > TEMP PROBES PRESENT.
	
11.	Connect either the 848719803 (5-ft) or the 848719811 (10-ft) cable to the 2-pin receptacle of the first probe and to the 3-pin receptacle of another probe.
12.	Verify the number of probes (2) registered with the controller with command: MENU > STATUS > BATTERIES > TEMP PROBES PRESENT.
13.	Repeat Steps 11-12 until all probes are installed and connected to corresponding ES771A modules.
14.	When all probes are installed, verify they are connected and operating with command: MENU > STATUS > BATTERIES > TEMP PROBES PRESENT.
15.	Connect the discrete voltage sense wire from the corresponding Battery Voltage Sense Cable to one of the three snap-fit pins on the corresponding ES771A module of each battery terminal where voltage monitoring is required. Note: 848719803, 848719811 and 848719829 Battery Voltage Sense Cables all come with a discrete voltage sense wire. Note: Each ES771A module supports up to three voltage monitoring leads, so if four battery strings are required the fourth voltage monitor probe must be connected to the second ES771A module.
16.	Trim and insulate the unused voltage sense wires on all remaining Battery Voltage Sense Cables.

The system is now set to monitor both voltage and temperatures to support the battery string voltage imbalance, battery high temperature disconnect, and slope thermal compensation features.

Setup Pulsar Controller

Circled below is the controller part of the block diagram. Input & Output Office alarms are wired to the controller by the customer as are LAN and Temperature Compensation probes.

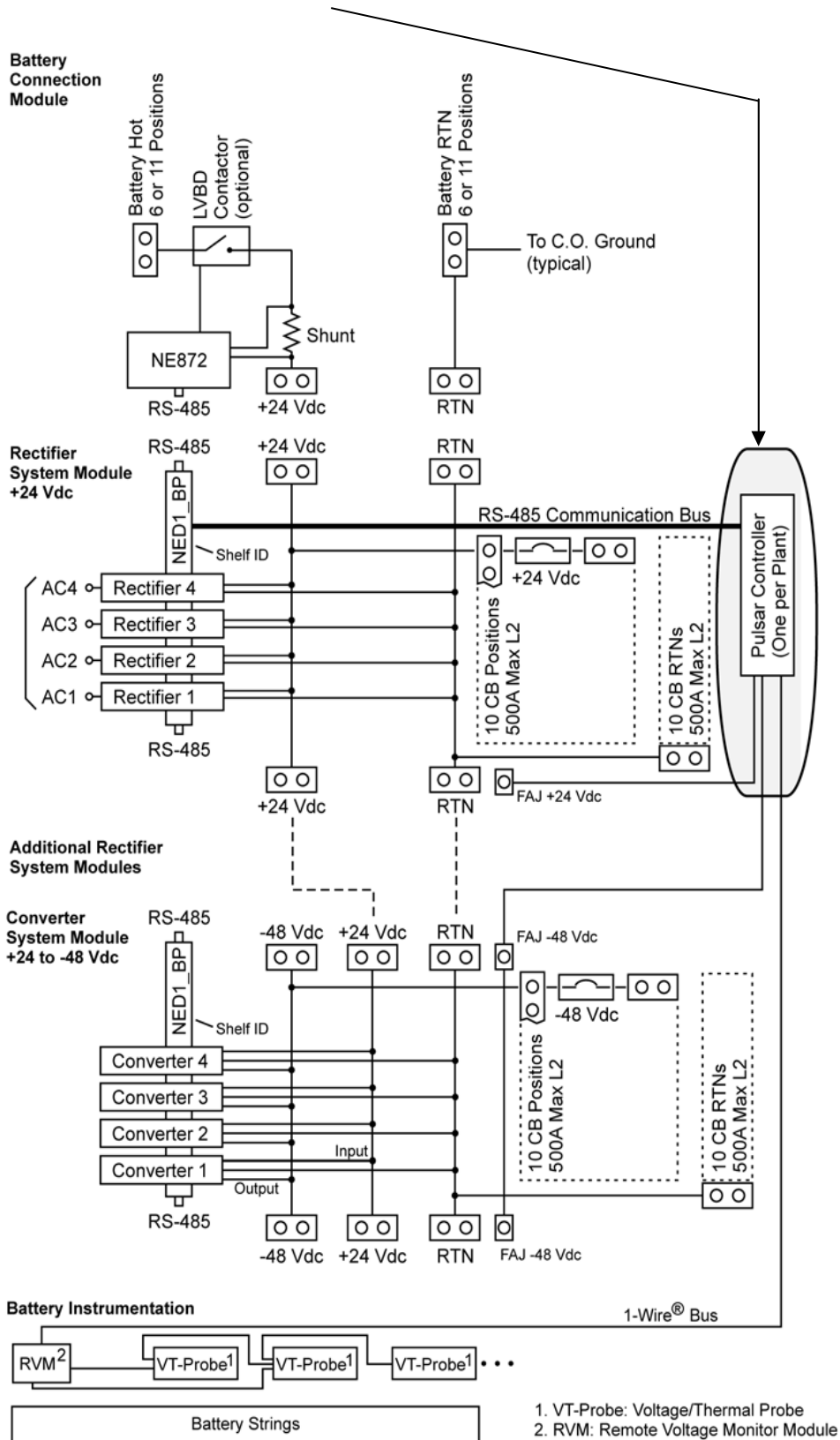

Install Controller Field Wiring

In addition to the temperature instrumentation, the controller has field connections for Alarm Inputs, Alarm Outputs and a Local Area Network (LAN).

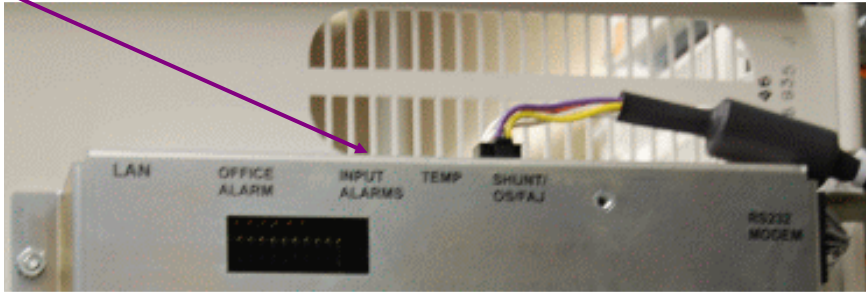
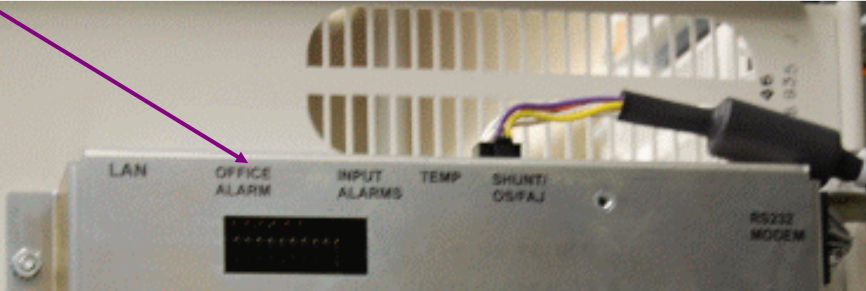
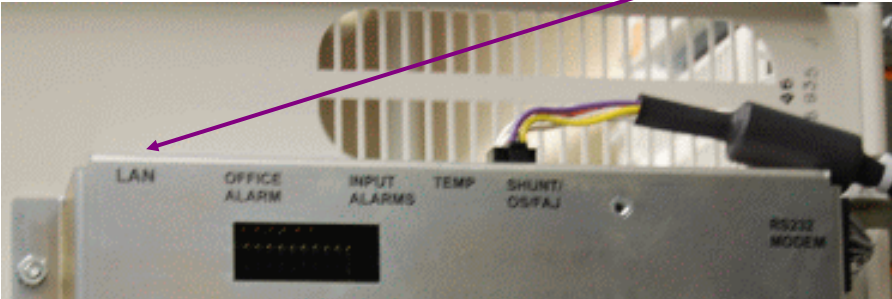
Step	Action
1.	<p>Insert the terminated end of the Alarm Input wireset (CC848817651) into the Input Alarms connector on the top edge of the controller.</p> 
2.	<p>Insert the terminated end of the Office Alarm Output wireset (CC848817635 or similar) into the office Alarm connector on the top edge of the controller.</p> 
3.	<p>Insert the terminated end of a 10/100Base-T CAT-5 LAN wire set into the LAN connector on the top edge of the controller.</p> 
4.	<p>Open the door to the widest position.</p>
5.	<p>Dress the field wiring using the tie points provided just behind the hinge to up and out the top of the cabinet.</p>
6.	<p>Check to make sure the door can open and close without straining the connectors.</p>

Change LAN to Server Mode

To access the controller directly from a PC, you must first change LAN connection to server mode.

Step	Action
1.	Press Menu or Accept key, ■ .
2.	Press down arrow, ▼, to Configuration.
3.	Press the right arrow key, □ (or square “accept” key, ■) to advance.
4.	Press down arrow, ▼, to Communications Ports.
5.	Press the right arrow key, □ (or square “accept” key, ■) to advance.
6.	Press down arrow, ▼, to Network Settings.
7.	Press the right arrow key, □ (or square “accept” key, ■) to advance.
8.	Press down arrow, ▼, to highlight DHCP.
9.	Press the right arrow key, □ (or square “accept” key, ■) to advance.
10.	Press down arrow, ▼, to toggle to SERVER.
11.	Press save, ■.
12.	Press the Back Arrow, ←, to return to the default screen.
13.	Wait 2 minutes.
14.	Activate changes by removing the latching PWR connection, located on the lower right of the controller, until the LEDs extinguish.
15.	Reapply power by reinserting the PWR connection until latched.
16.	Verify Server Mode by pressing Menu>Status>Network Settings>Port 1> to find 192.168.2.1 as the network address.

Warning: It is always safer to leave the controller in Client mode. This avoids LAN conflicts should the controller ever be connected to a Local Area Network.

Restore the LAN Connection to Client Mode

As good policy, always leave the controller in Client mode.

Step	Action
1.	Press Menu or Accept key, ■.
2.	Press down arrow, ▼, to Configuration.
3.	Press the right arrow key, □ (or square “accept” key, ■) to advance.
4.	Press down arrow, ▼, to Communications Ports.
5.	Press the right arrow key, □ (or square “accept” key, ■) to advance.
6.	Press down arrow, ▼, to Network Settings.
7.	P Press the right arrow key, □ (or square “accept” key, ■) to advance.
8.	Press down arrow, ▼, to highlight DHCP.
9.	Press the right arrow key, □ (or square “accept” key, ■) to advance.
10.	Press down arrow, ▼, to toggle to CLIENT.
11.	Press save, ■.
12.	Press the Back Arrow, ←, to return to the default screen.
13.	Wait 2 minutes.
14.	Activate changes by removing the latching PWR connection, located on the lower right of the controller, until the LEDs extinguish.
15.	Reapply power by reinserting the PWR connection until latched.
16.	Verify Client Mode by pressing Menu>Configuration>Communications Ports>NetworkSettings> to show Client mode.

Miscellaneous Alarms (Batteries must be connected)

Distribution Alarms

Step	Action
1.	Manually connect a piece of wire from the circuit breaker feed bus to the distribution alarmstrip.
2.	Verify an FAJ – Fuse Alarm Major is reported by the controller.
3.	Remove the wire. Verify the alarm clears.
	Repeat test for each distribution panel or sub-system.

ac Fail Alarms

Step	Action
1.	Turn off ac circuit breaker feeding a single rectifier.
2.	Verify ACF – ac Fail Minor is reported for the correct rectifier ID.
3.	Restore ac and verify alarms clear and the controller returns to Normal.
4.	Remove ac from two or more rectifiers.
5.	Verify MACF – Multiple ac Fail Major is reported for the correct rectifier IDs.
6.	Turn on all ac circuit breakers and verify alarms clear and the controller returns to Normal.

Battery On Discharge Alarms (Batteries Connected)

Step	Action
1.	Change BD alarm to 2 volts below float voltage (MENU > CONFIGURATION > FLOATSETTINGS > VOLTAGE ALARMS > BD).
2.	Adjust the load to 50 amperes.
3.	Turn off ac to the system.
4.	Verify the BD alarm occurs when the system voltage decreases to BD threshold.
5.	Verify the BD alarm clears once the voltage has exceeded 0.5V above the BD alarm threshold.
6.	Restore the BD alarm threshold to its previous setting.

High Float Voltage Alarms (No Load)

Step	Action
1.	Confirm the HV alarm threshold (MENU > CONFIGURATION > FLOAT SETTINGS > VOLTAGE ALARMS > HIGH).
2.	Adjust the float voltage to a value greater than this threshold (MENU>CONFIGURATION>FLOAT SETTINGS>SETPOINT).
3.	Verify an HV alarm is reported by the controller.
4.	Restore the float voltage back to its original setting.
5.	Restore the HV setting back to its original setting.
6.	Verify the alarms clear and the controller returns to Normal.

Manual Contactor Control and Alarms

WARNING: If this is an operating plant with loads, skip this test.

Step	Action
1.	Open the contactor by controller command (MENU > CONTROL / OPERATIONS >DISCONNECTS).
2.	Verify the controller reports a Contactor Open alarm.
3.	Close the contactor by controller command.
4.	Verify the alarms clear and the controller returns to Normal.

Automatic Contactor Control and Alarms

WARNING: If this is an operating plant with loads, skip this test.

Step	Action
1.	Check the disconnect thresholds (MENU > CONTROL / OPERATIONS >DISCONNECTS).
2.	Adjust the float voltage to a value less than this threshold (MENU > CONFIGURATION >FLOAT SETTINGS > SET POINT).
3.	Disconnect the batteries in the plant.
4.	Verify the battery disconnect opens and the controller reports a Contactor Open alarm.
5.	Restore the plant voltage back to its original setting.
6.	Verify the contactor closes.
7.	Verify the alarms clear and the controller returns to Normal.

5.Troubleshooting

The Block Diagram below is a first step to troubleshooting an Infinity D Plant.

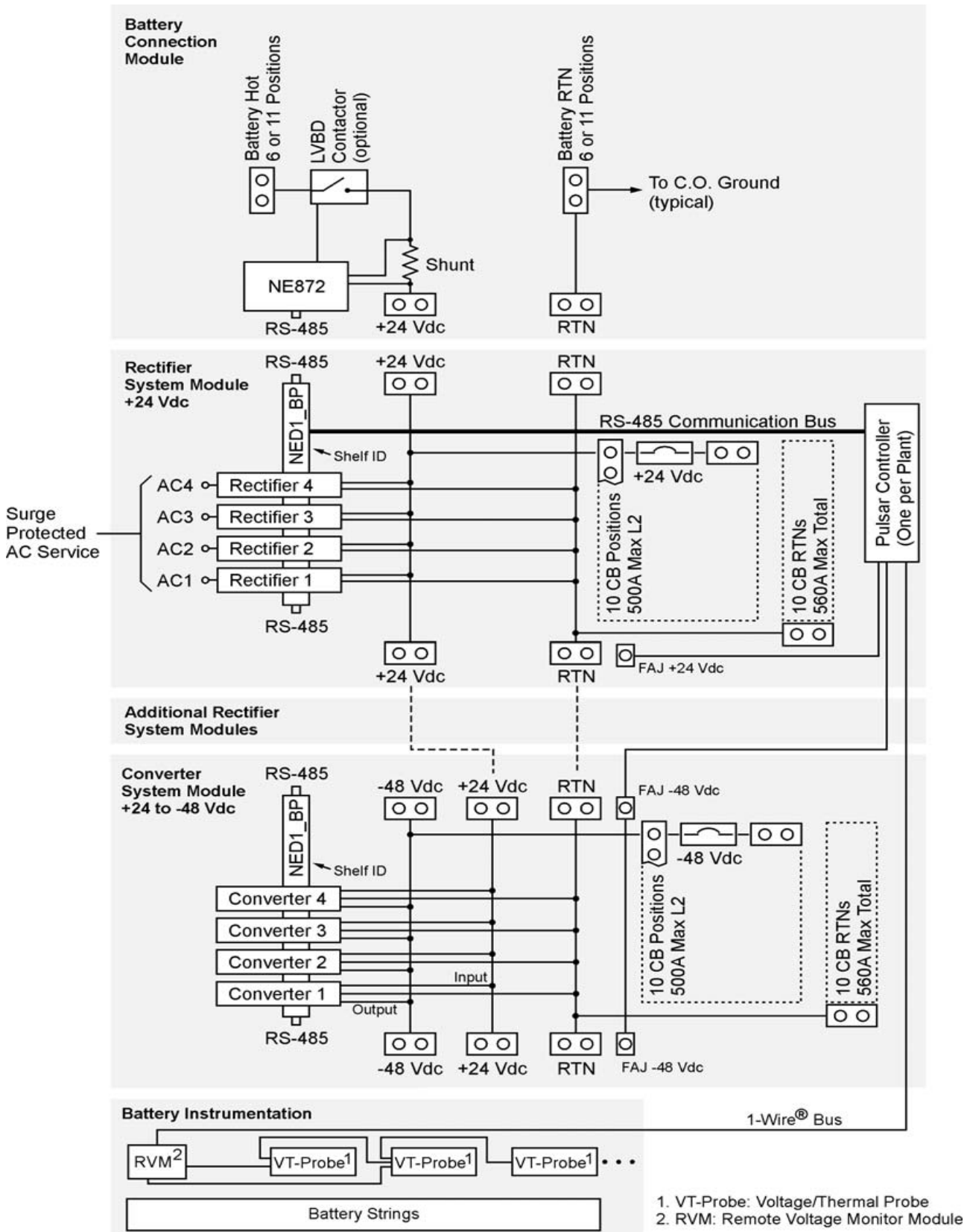

Troubleshooting NE-Series Rectifiers/Converters

The status of an NE-Series rectifier or converter is provided by LEDs on their face, and by extensive real time data, alarm and event history accessible through the system controller.

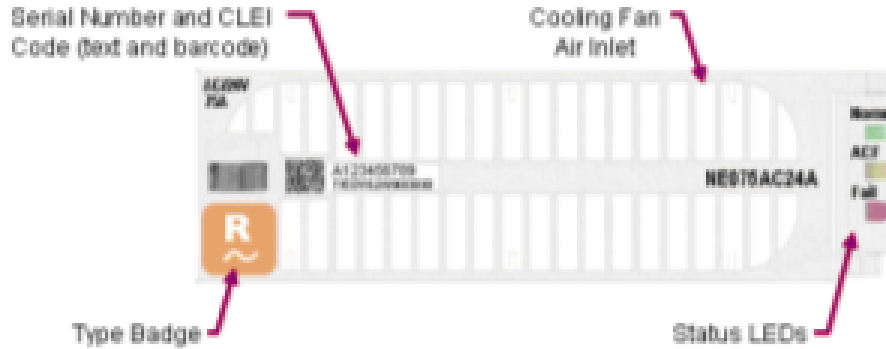

Rectifier/Converter Status LEDs

LEDs	Condition
Norm green ACF <input type="checkbox"/> off Fail <input type="checkbox"/> off	Normal operation: No alarms, inputs and outputs are in their normal range, communicating with the system controller.
Norm <input type="checkbox"/> off ACF <input type="checkbox"/> off Fail <input type="checkbox"/> off	Unpowered: No input or output voltage present. <ol style="list-style-type: none"> 1. Remove and reinsert unit. 2. Check input voltage with a voltmeter, if input voltage is present, replace unit. 3. Check output bus voltage with a voltmeter, if output bus voltage is present, replace unit.
Norm green blink ACF <input type="checkbox"/> off Fail <input type="checkbox"/> off	Standby: The unit is okay, but has been placed in Standby by the controller and is not delivering power. Note: If a unit in standby loses communications with the controller it will exit Standby mode and deliver power
Norm amber ACF <input type="checkbox"/> off Fail <input type="checkbox"/> off or red blink	Output Limit: The unit is okay and delivering maximum output At max rated output At configured current limit At thermal limit If rectifiers/converters are equipped with optional air filters and reporting thermal limiting, check air filters. Clean or replace all filters if necessary. View rectifier currents: STATUS > RECTIFIERS > RECTIFIER CURRENTS.

LEDs	Condition
Norm <input type="checkbox"/> off ACF <input checked="" type="checkbox"/> amber Fail <input type="checkbox"/> off or red blink	ACF [ac Fail]: Rectifier input is missing or out of range. Correct ac fault. In F [Input Fail]: Re-labeled LED on converter indicates Converter input is out of range. Correct converter input fault.
Norm <input type="checkbox"/> off ACF <input type="checkbox"/> off or amber Fail <input checked="" type="checkbox"/> red	Shutdown*: The unit cannot deliver output. <ul style="list-style-type: none"> • High Voltage Shutdown • Thermal Shutdown • Under Voltage Protect • Component failure <ol style="list-style-type: none"> 1. Check rectifier or converter status on controller display to determine cause of shutdown 2. Correct system output short, high temp, etc. 3. Remove and reinsert unit. If fault remains and other units are functioning correctly, replace unit.
Norm <input type="checkbox"/> any ACF <input type="checkbox"/> off or amber Fail <input checked="" type="checkbox"/> red blink	Communication Fail: Blinks to indicate the rectifier is not communicating with a system controller. Remove and reinsert unit. If fault remains and other units are communicating correctly, replace unit.

When a power unit senses an over- or under-voltage condition it will shutdown, wait 10 seconds, and then attempt to restart. If the over- or under-voltage condition remains it will cycle again. If the rectifier is loaded more than 10%, after 3 restart attempts the unit will lock out, and user intervention is required to restart.

Troubleshooting VT-Probes

Checking for Defective VT-Probes

(If a Voltage Channel Failure and/or Thermal Probe Failure alarm occurs)

Step	Action
1.	Disconnect the first probe from its RJ-45 terminal block.
2.	Run the command: MENU > CONTROL / OPERATIONS > UNINSTALL EQUIPMENT.
	Is the system controller green Normal LED lit?
3.	Yes – Removed probe is defective. Replace it. Finished. No – Reinstall the removed probe. Proceed to Step 4.
4.	Remove the next probe.
5.	Go to Step 2. Repeat steps for all probes.

6. Product Warranty

- A. Seller warrants to Customer only, that:
1. As of the date title to Products passes, Seller will have the right to sell, transfer, and assign such Products and the title conveyed by Seller shall be good;
 2. During the warranty period stated in Sub-Article B below, Seller's Manufactured Products (products manufactured by Seller), which have been paid for by Customer, will conform to industry standards and Seller's specifications and shall be free from material defects;
 3. With respect to Vendor items (items not manufactured by Seller), Seller warrants that such Vendor items, which have been paid for by Customer, will be free from material defects for a period of sixty (60) days commencing from the date of shipment from Seller's facility.
- B. The Warranty Period listed below is applicable to Seller's Manufactured Products furnished pursuant to this Agreement, commencing from date of shipment from Seller's facility, unless otherwise agreed to in writing:

Warranty Period

Product Type	New Product	Repaired Product*
Central Office Power Equipment**	24 Months	6 Months
<p>* The Warranty Period for a repaired Product or part thereof is six (6) months or, the remainder of the unexpired term of the new Product Warranty Period, whichever is longer.</p> <p>** The Warranty Period for Products ordered for Use in Systems or equipment Manufactured by and furnished by Seller is that of the initial System or equipment.</p>		

- C. If, under normal and proper use during the applicable Warranty Period, a defect or nonconformity is identified in a Product and Customer notifies Seller in writing of such defect or nonconformity promptly after Customer discovers such defect or nonconformity, and follows Seller's instructions regarding return of defective or nonconforming Products, Seller shall, at its option attempt first to repair or replace such Product without charge at its facility or, if not feasible, provide a refund or credit based on the original purchase price and installation charges if installed by Seller. Where Seller has elected to repair a Seller's Manufactured Product (other than Cable and Wire Products) which has been installed by Seller and Seller ascertains that the Product is not readily returnable for repair, Seller will repair the Product at Customer's site.
- With respect to Cable and Wire Products manufactured by Seller which Seller elects to repair but which are not readily returnable for repair, whether or not installed by Seller, Seller at its option, may repair the cable and Wire Products at Customer's site.
- D. If Seller has elected to repair or replace a defective Product, Customer shall have the option of removing and reinstalling or having Seller remove and reinstall the defective or nonconforming Product. The cost of the removal and the reinstallation shall be borne by Customer. With respect to Cable and Wire Products, Customer has the further responsibility, at its expense, to make the Cable and Wire Products accessible for repair or replacement and to restore the site. Products returned for repair or replacement will be accepted by Seller only in accordance with its instructions and procedures for such returns. The transportation expense associated with returning such Product to Seller shall be borne by Customer. Seller shall pay the cost of transportation of the repaired or replacing Product to the destination designated by Customer.

- E. Except for batteries, the defective or nonconforming Products or parts which are replaced shall become Seller's property. Customer shall be solely responsible for the disposition of any batteries.
- F. If Seller determines that a Product for which warranty service is claimed is not defective or nonconforming, Customer shall pay Seller all costs of handling, inspecting, testing, and transportation and, if applicable, traveling and related expenses.
- G. Seller makes no warranty with respect to defective conditions or nonconformities resulting from actions of anyone other than Seller or its subcontractors, caused by any of the following: modifications, misuse, neglect, accident, or abuse; improper wiring, repairing, splicing, alteration, installation, storage, or maintenance; use in a manner not in accordance with Seller's or Vendor's specifications or operating instructions, or failure of Customer to apply previously applicable Seller modifications and corrections. In addition, Seller makes no warranty with respect to Products which have had their serial numbers or month and year of manufacture removed, altered, or experimental products or prototypes or with respect to expendable items, including, without limitation, fuses, lightbulbs, motor brushes, and the like. Seller's warranty does not extend to any system into which the Product is incorporated. This warranty applies to Customer only and may not be assigned or extended by Customer to any of its customers or other users of the Product.

THE FOREGOING WARRANTIES ARE EXCLUSIVE AND ARE IN LIEU OF ALL OTHER EXPRESS AND IMPLIED WARRANTIES, INCLUDING BUT NOT LIMITED TO WARRANTIES OF MERCHANTABILITY AND FITNESS FOR A PARTICULAR PURPOSE. CUSTOMER'S SOLE AND EXCLUSIVE REMEDY SHALL BE SELLER'S OBLIGATION TO REPAIR, REPLACE, CREDIT, OR REFUND AS SET FORTH ABOVE IN THIS WARRANTY.

Appendix A: Pulsar Controller

User Interface Overview

The Galaxy Pulsar Plus NE843 family of controllers monitor and control system components including rectifiers, converters, and distribution modules via a multi-drop RS485 digital communications bus. System status, parameters, settings, and alarm thresholds can be viewed and configured from the controller's front panel display. Assignment and configuration of alarm inputs and output relays can be performed from a laptop computer connected to a local RS-232 or Ethernet port, or by remote access is through a network connection to the World Wide Web (internet) or your enterprise network (intranet). An optional modem is also available.

This section describes the controller features, functions and alarms from perspective of a user utilizing the front panel display. All these features are available through the remote interfaces including Easy View and Web pages served by the controller. Easy View is the Lineage Power Systems GUI provided for local serial port or remote MODEM access. It supports all Lineage controllers and has been around for many years and will not be discussed in detail. The web interface and front panel will be the interfaces of choice. This section focuses on describing the controller from the front panel perspective since it is the most available interface and requires no PC or computer hardware. The items contained in the front panel are applicable to respective feature implementations in the web pages.

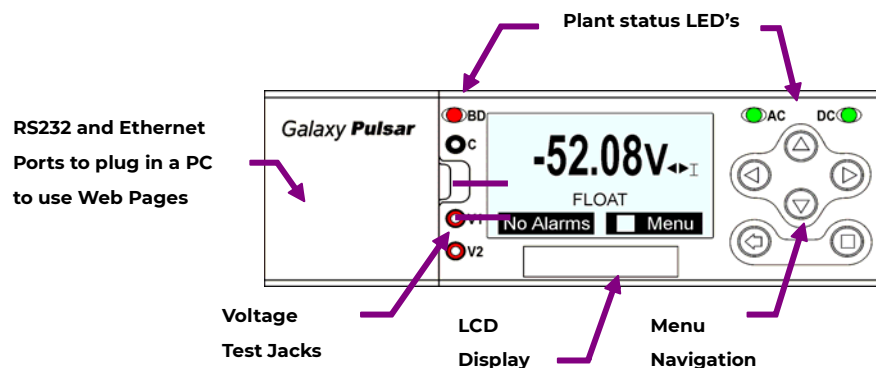









Figure 5-1: NE843A/NE843C Front Panel Main Display

This display shows the front panel display for a system with both rectifiers and converters. The display (V1 versus V2) correlates with test jacks. The large font indicates the "Primary" or rectifier dc bus; the smaller font shows the "Secondary" or converter dc bus. The NE843 will automatically determine the appropriate fonts and test jack designations.

For systems with no converters only a single voltage/current pair will be displayed on the front panel along with the correct test jack association. The other test jack will be unused and will have near zero voltage.

Menu Navigation Buttons





The NE843 has six tactile buttons to use to navigate through a structured menu system. The buttons serve multiple purposes depending on the screen a user is at. These functions are summarized below.

Buttons	Description	
 	Display Contrast	In the Main Display, the ▲▼ buttons increase or decrease the display contrast. Contrast adjustment is also available through the menus at Menu->Configuration->System Settings.
	Parameter Change	When changing a system parameter, the ▲▼ button increase or decrease the value of the parameter.
   	Direction Buttons	In the Menus, the ◀▶ direction buttons navigate to make a selection. A black box highlighting a menu item indicates that the item has sub-menus.
	Enter Button	Enters a sub-menu or confirms a parameter change. From the Home Page only, goes to the top level Main menu.
	ESC Button	Goes up one menu level or exits a parameter change Without saving.

System Status Display

LCD Backlight

The Pulsar Plus NE843 controller family incorporates an alarm sensitive back-light indicator to help assist in providing a clear indication of the system status. Severities of alarms can be configured through the remote interfaces. Following is a basic description of the backlight functionality.

	<p>The incorporated display technology can support a wide range of backlight colors. Present implementation supports three basic colors to indicate the alarm severity present in the system: Green, Amber, and Red</p> <p>The highest severity in the system will take precedence.</p>	
Status	Function	Condition
 green	Normal	Normal operation, no alarms, inputs and outputs are in their normal range.
 red	Critical Alarm	Highest severity. Generally assigned to alarm to indicate a Power affecting condition. Immediate attention required.
 red	Major Alarm	High severity. Generally assigned to alarm to indicate a Power affecting condition. Immediate attention required.
 amber	Minor Alarm	Medium severity. Generally assigned to alarm to indicate a non-power affecting condition. Attention eventually required.

NE843 Status LEDs

The Pulsar Plus NE843 controller family provides three separate LED indicators to help assist in providing more specific indications of the system status. These LEDs provide are used to providespecific indication concerning the AC and DC system status as well as a separate indicator for a Battery on Discharge state. These LEDs have factory assigned defaults as indicated in the table below. However, the assignments to alarms can be customized in the field using the remote interfaces.

LED	Status	Condition
AC	green	AC input to all rectifiers is in range.
	amber	AC input to one rectifier is missing or out of range.
	red	AC input to two or more rectifiers is missing or out of range.
DC	green	DC output to all loads is normal.
	amber	One or more of the following alarms are present: Fuse Minor 48, Fuse Minor 24
	red	One or more of the following alarms are present: Open String, LVBD Open, Fuse Major 48, Fuse Major 24
BD	green	System above configured Battery on Discharge (BD) threshold.
	green	Blinks at an On/Off Rate of 1/2 second ON 1/4 second Off to indicate a manual or automatic battery test in progress.
	amber	State not presently assigned.
	red	System equal to or below configured Battery on Discharge(BD) threshold.

Audible Alarm



The Pulsar NE843 has an integrated audible alarm located in its display assembly. This alarm will sound when any Critical, Major, or Minor alarm is detected by the controller. Upon assertion of the audible alarm the default frontpanel will provide and indicator of the alarm as well as a quick link to temporarily cut-off the alarm.

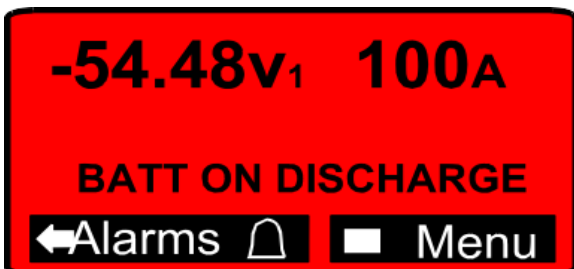

Pressing the arrow key provides a quick link to temporarily cut-off the audible alarm.

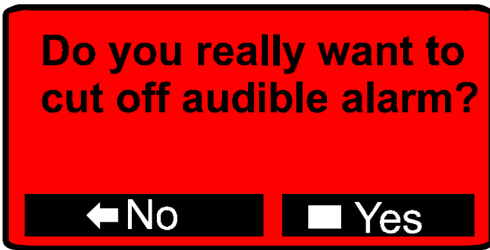

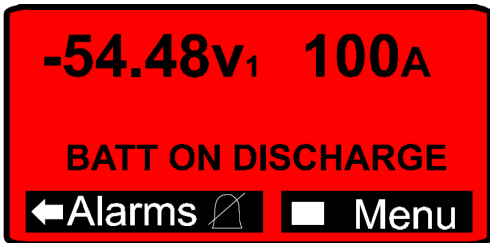

Once the audible cut-off is selected the alarms present in the system are listed. An indicator on the default front panel screen is provided to inform that the audible alarm cutoff is active. The audible alarm can also be turned-back on following similar procedures.



The audible alarm may be disabled altogether through proper configuration at the front panel or through remote means.



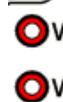

Voltage Test Jacks

The Pulsar Plus NE843 has three test jacks that allow you to measure the system output voltage with a hand-held meter. The jacks are referenced with C (Common), V1 (Voltage One), and V2 (Voltage Two). The voltage references correspond to the voltage referenced on the default front panel screen.

- 
 Thus, one system voltage can be measured between C and V1 and a second output voltage can be measured between C and V2. A voltage will not be present on one of the voltage test jacks if the controller resides in only a single voltage system.
- 
- 

Local and Remote Access Ports

The Pulsar Plus NE843 provides ports for both local and remote access. Access to these ports depends on the specific NE843 configuration. The NE843A and NE843C have a front panel located to the left of the test jacks that provide access to a local DB-9 RS232 asynchronous serial port in some configurations. There is also space allocated for an RJ45 receptacle that will be used to access a second 10/100Base-T Ethernet port in the future. NE843A and NE843B controller configurations provide an RJ45 located at the side of the chassis to access Ethernet port that is integrated into all NE843 configurations. NE843 configuration options also provide a standard RJ11 for the telephone line interface located on the side of the slot-controllers or directly on the modem itself.



Port	Description
<p>Front Panel</p> <p>J7</p>  <p>RS-232</p>  <p>Ethernet</p> <p>J8</p>	<p>A laptop PC can be connected to standard DB9 connector J7 to provide a ground-referenced RS-232 serial connection using Easy View for local access. The port can also be configured to be used with an external modem.</p> <hr/> <p>A position (as shown below) is reserved for a second RJ45 Ethernet connection in the future. It is covered for now.</p> 
<p>Side</p>  <p>J8</p>  <p>J8</p>	<p>An RJ-45 Ethernet connector, Connector J5, on side (slot-mounted) or top (door-mounted) of unit, is provided for the integrated 10/100 Base-T network. Connection. This connection can be used for remote monitoring or as a local Craft port. In the remote monitoring mode, this port is compatible with LineagePower Galaxy Manager or other SNMP based programs used for web-based remote access and network management.</p> <p>NE843 controllers equipped with an optional modem provide a standard RJ11(J6) for a telephone line connection.</p>

Front Panel Menu Structure

Feature content at the front panel is functionally divided at the NE843's Main Menu into the following categories:

- **Alarms**
- **Warnings**
- **Status**
- **Control/Operations**
- **History**
- **Configuration**

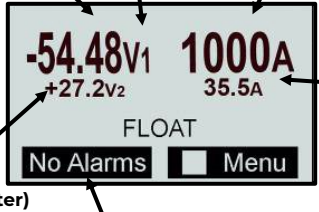
Access to the main menu starts at the default front panel screen shown below.

<p style="text-align: center;">Front Panel Default Menu</p>  <p>The screenshot shows a digital display with the following information: <ul style="list-style-type: none"> Top left: -54.48V₁ (labeled Plant Voltage (rectifier)) Top right: 1000A (labeled Plant Current (Load)) Bottom left: +27.2V₂ (labeled Plant Voltage (Converter)) Bottom right: 35.5A (labeled Plant Current (Converter)) Center: FLOAT Bottom: No Alarms (with a small square icon) and Menu (with a small square icon) </p>	<p>The front panel default screen displays the primary and secondary (if present) bus voltages along with their respective total load in two different fonts.</p> <p>The operating mode of the system is also displayed. The displayed operating modes possible are: Float, Battery On Discharge, Boost, etc. An alarm soft-key as well as the backlight will indicate when alarms are present. Pressing the ⏏ will access the alarm cut-off as well as the alarms and warnings present in the system.</p> <p>Pressing the o button accesses the main menu and the feature categories previously listed.</p>
<p style="text-align: center;">Main Menu</p>  <p>The screenshot shows a list of menu options: <ul style="list-style-type: none"> Status (highlighted) Control / Operations History Configuration </p>	<p>Access to alarms, warnings, equipment status detail, basic control and operations for maintenance purposes, and system configuration can be obtained.</p> <p>Note: the NE843 has the ability to have a front Panel Password that limits configuration as well as some operations. A person with administrator level access can enable this feature through the remote interfaces. Standard NE843 controllers are shipped from the factory with this feature disabled.</p>

Front Panel PIN

The Pulsar Plus NE843 has the ability to restrict certain types of access from the front panel of the unit. It has the ability to enforce a four-digit Power Identification Number (PIN) requirement for users of the front panel for certain control/operations and configurable items. This feature is disabled in the factory in the standard NE843 controller offerings and must be enabled by a remote user with administrator level privileges. When the front panel PIN feature is enabled, the factory default for the PIN is **0000**. Each position of the password is configurable between 0-9. A sample screen like that following is required for PIN access.

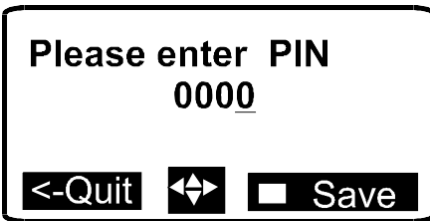

The up, down, left and right arrows are used to enter the appropriate password. Upon entering a correct PIN the following momentary screen shows up and then disappears leaving the user at the menu location prior to entering the PIN.



A user must enter the PIN for items that generally are not deemed as functions of a typical maintenance routine. It is assumed that the majority of the configured thresholds and system operational features will not be changed through a maintenance routine. Thus, entering the correct PIN will be required in order for these specific types of parameters or features to be modified in the field. These same rules are implemented when accessing through the Craft

port. In addition to Configuration items, there are some Control/Operations that also require the PIN. These are shown below.

1. Clear History
2. Clear Statistics
3. Disconnects – Manual disconnect/reconnect of any LVLD/LVBD
4. Enter Boost

Other Control/Operations features listed below do not require PIN access.

1. Lamp Test
2. Restart Rectifiers
3. Uninstall Equipment
4. Start Battery Test
5. Start Alarm Test
6. Load Factory Defaults

All configuration items from the front panel require PIN access except for the following:

1. Battery Type
2. String Battery Capacity (AH)
3. Number Of Battery Strings
4. Manual Discharge Test Type
5. Manual Test Duration
6. Manual Test Check Battery Alarm Voltage Threshold
7. Battery Test Rectifier Voltage
8. System Date Format
9. System Date
10. System Time Format
11. System Time
12. Automatic Daylight Savings Feature
13. Display Contrast
14. Temperature Display Units
15. Alarm Test Feature
16. Alarm Test Relay Duration and Relay

Once a user enters the PIN, total front panel access is allowed for:

- As long as the user remains in menus other than the default menu and/or
- The default display has remained on the front panel for more than user configurable time-out value. The NE843 has a factory configured default of 120 minutes. This time is adjustable between 1-120 minutes in 1 minute increments. 120 minutes is the factory default.
- An internal counter shall be kept and reset if the user leaves the default menu and returns to other menus before the time-out period is reached.

Front Panel Menu Flow

The following figures provide a menu flow map for each primary category. This information is followed up with brief descriptions of each of the menu items. **Alarms** and **Warnings** are not hierarchal mapped and are presented in chronological order of occurrence when they are present. No Active Alarms or No Active Warnings will be displayed when they are no alarms or warnings detected by the controller.

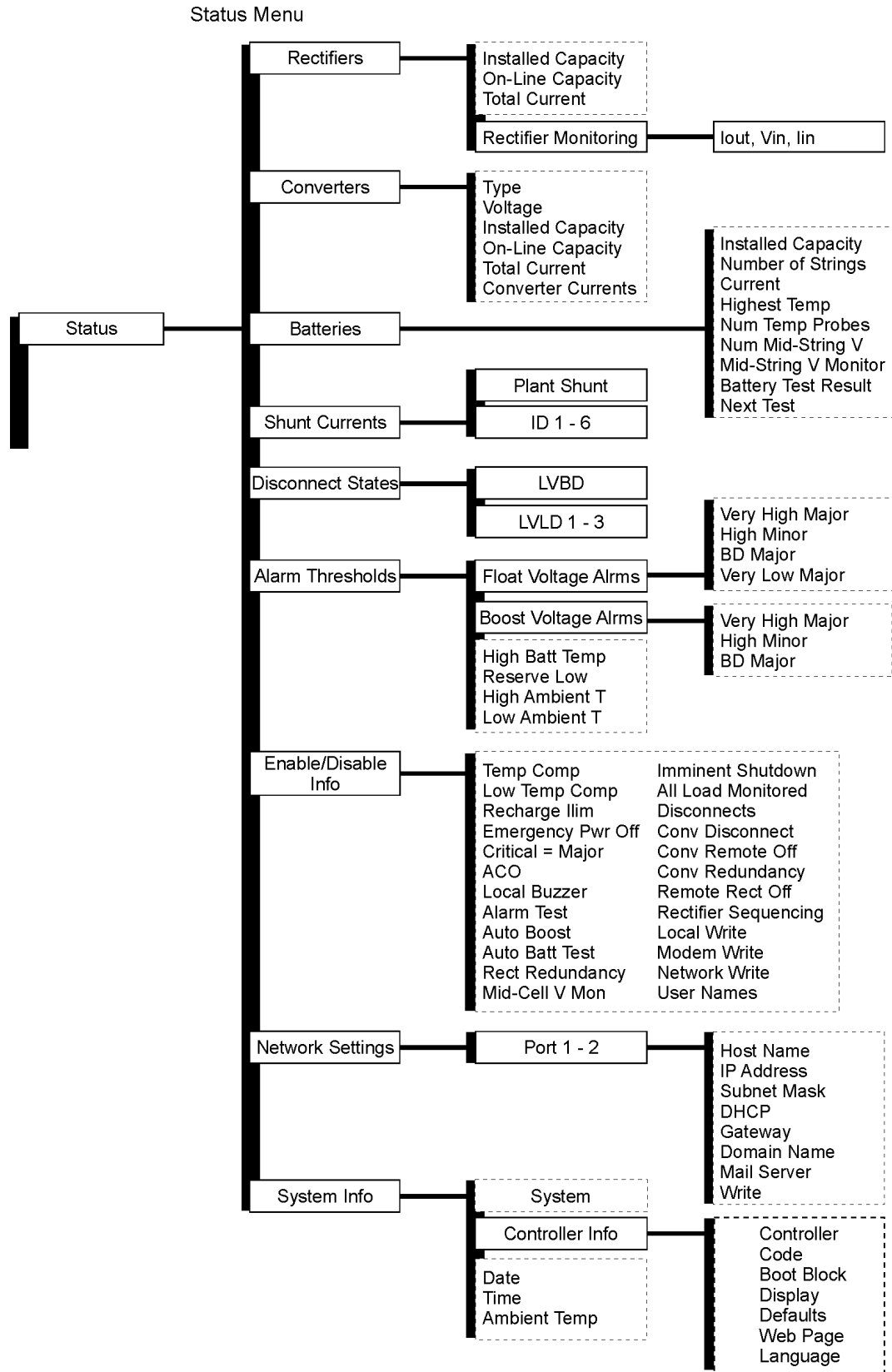

Figure 5-3: Status Menu

Control / Operation
and
History Menus

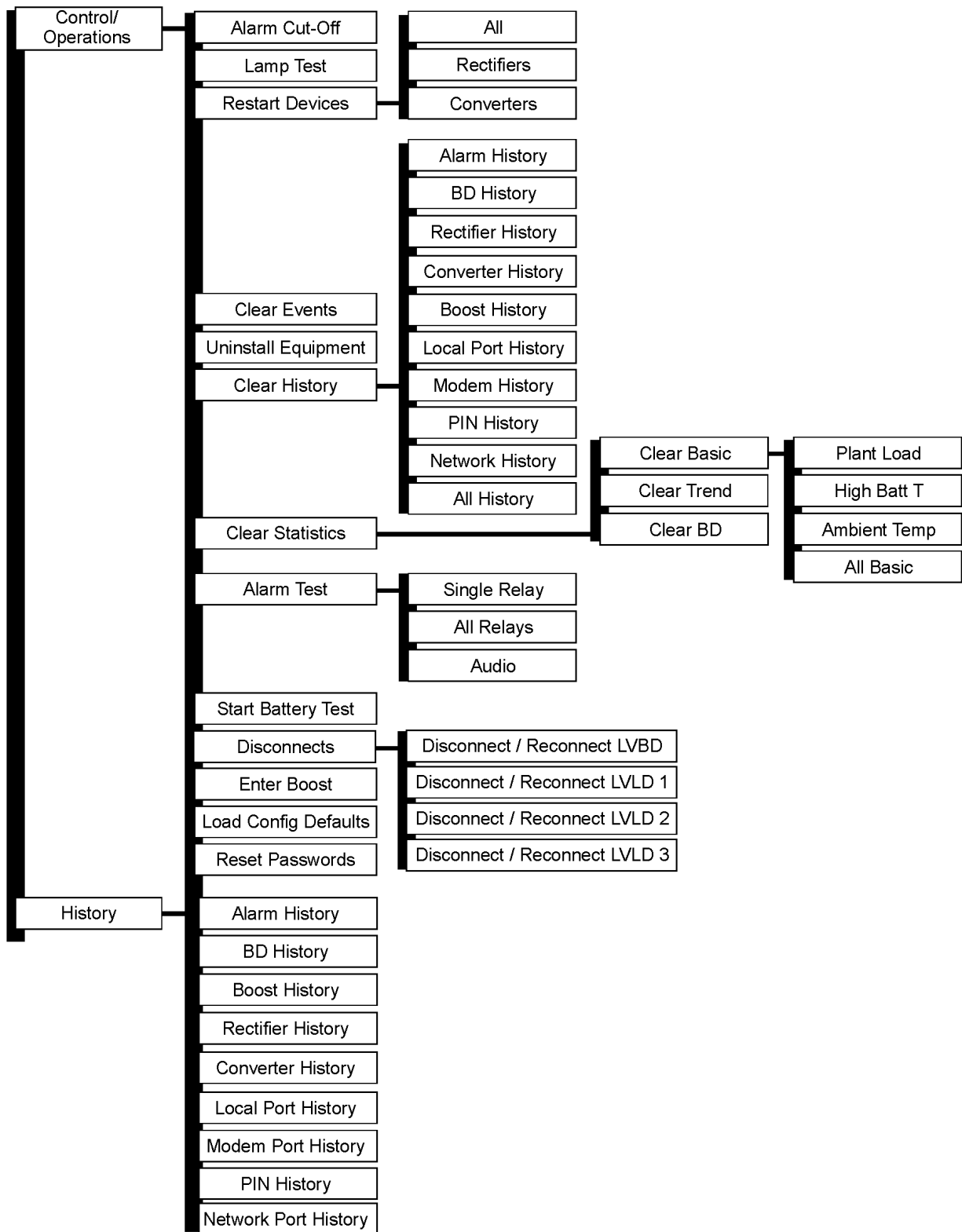
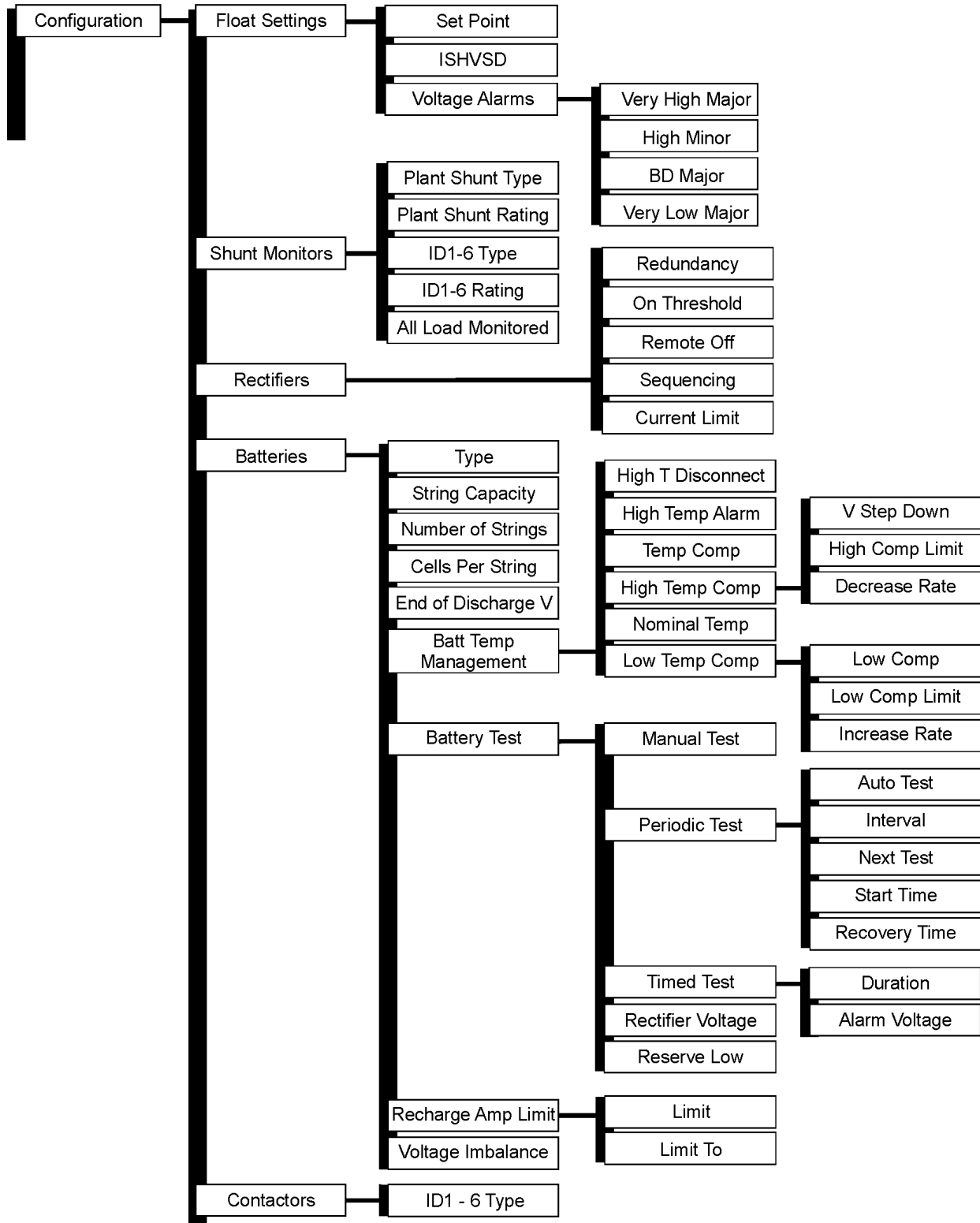

Figure 5-4: Control / Operations and History Menus

Configuration Menu



Continued on
Next Page

Figure 5-5: Configuration Menu (part 1)

Configuration Menu
(continued)

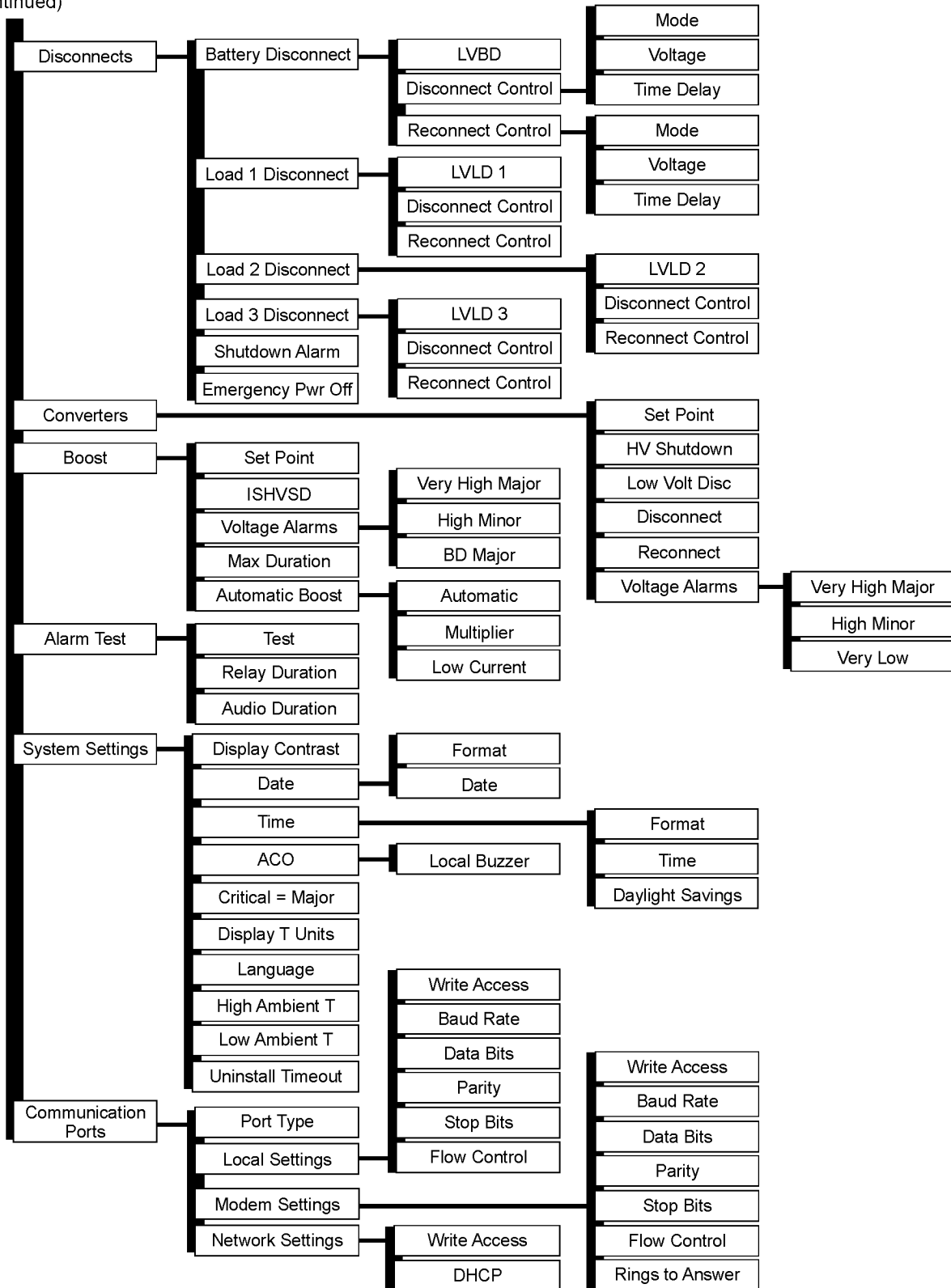

Figure 5-6: Configuration Menu (part 2)

Appendix B: Reference Information

Pulsar Controller Field Wiring Connector Definitions

One-Wire Battery Peripheral Connector

Temp is a standard shielded RJ-45 receptacle provided for making connections to one-wire QS873 VT-Probes and or to the ES771A Remote Mid-string Voltage Monitor. Standard cable assemblies have been designed and are available for different applications with the QS873 VT-Probes or ES771 Remote Mid-string Voltage monitors that allow simple plug-n-play.

Pin #	SignalName	Description
1	reserved	
2	reserved	
3	SIG_RTN	Protected signal return for 1-wire
4	reserved	
5	1-Wire	1-wire communication signal
6	+5V	Protected +5V Power utilized by ES771 modules
7	reserved	
8	reserved	

Input Alarms Connector

Input Alarms is 10-pin right angle header that provides a separate connection for auxiliary inputs. Standard color coded cable assemblies are available. Comcodes for the 50' and 150' input cables are CC848817651 and CC848817668, respectively. Contact technical field support for additional cable options.

Pin # (Wire Color)	Signal Name	Description
1 (BK)	Aux Input 1 (Aux1)	Auxiliary input to monitor a contact closure or open to its respective return on pin 8, Auxiliary Input Return. See Appendix E for alarm assignments
2 (BR)	Aux Input 2 (Aux2)	Auxiliary input to monitor a contact closure or open to its respective return on pin 8, Auxiliary Input Return. See Appendix E for alarm assignments
3 (R)	Aux Power Major Input (AMJ)	Auxiliary input to monitor a contact closure to the non-grounded side of a dc bus ($\pm 24V/-48V$) to create the standard Auxiliary Power Major alarm. See Appendix E for alarm assignments
4 (O)	Plant Battery Test/ Group Standby/TR (GSTR)	Dedicated input to be monitored for a contact closure to its respective return on pin 9. Used for Plant Battery Test and Group Standby Feature. Factory default as the Group Standby feature upon a contact closure.
5 (Y)	Emergency Power Off (EPO)	Dedicated EPO input to be monitored for a contact closure to its respective return on pin 10, Emergency Power Off Return.
6 (G)	Aux Input 3 (Aux3)	Auxiliary input to monitor a contact closure or open to its respective return on pin 8. See Appendix E for alarm assignments.
7 (BL)	Aux Input 4 (Aux4)	Auxiliary input to monitor a contact closure or open to its respective return on pin 8. See Appendix E for alarm assignments.
8 (V)	Aux Input Return (Aux_R)	Return for Auxiliary Inputs 1-4.
9 (S)	Plant Battery Test/ Group Standby (TR) Ret.(GSTR_R)	Return for Plant Battery Test and Group Standby.
10 (W)	Emergency Power Off Ret. (EPO_R)	Return for EPO input.

Office Alarm Connector

All standard controller output alarm connections are available from the output connector. Connector **J4** provides access to the primary customer alarm output interface. Connector J4 is a 20-pin right angle header with latching capability. Standard color coded cable assemblies are available. Comcodes for the 50' and 150' input cables are CC848817635 and CC848817643, respectively. Contact technical field support for additional cable options.

Pin # (Wire Color)	Signal Name	Twisted Pair	Pin # (Wire Color)	Signal Name	NE843 Standard Defaults
1 (BL)	PCR	&	11 (W)	PCR_C	PCR (Power Critical)
2 (O)	PMJ	&	12 (W)	PMJ_C	PMJ (Power Major)
3 (G)	PMN	&	13 (W)	PMN_C	PMN (Power Minor)
4 (BR)	UR1	&	14 (W)	UR1_C	BD (Battery on Discharge)
5 (S)	UR2	&	15 (W)	UR2_C	VLV (Very Low Voltage)
6 (BL)	UR3	&	16 (R)	UR3_C	FAJ (External Fuse Major)
7 (O)	UR4	&	17 (R)	UR4_C	ACF (ac Fail)
8 (G)	UR5	&	18 (R)	UR5_C	RFA (Rectifier Fail)
9 (BR)	UR6	&	19 (R)	UR6_C	MRFA (Multi Rectifier Fail)
10 (S)	UR7	&	20 (R)	UR7_C	HV (High Voltage)

Note: Configuration jumpers for the alarm outputs have been set to provide an “Open” on alarm from the factory. Alarm contact type can be changed – see Advanced Features User Guide.

Network (LAN) Connection (Optional)

The NE843 provides an Ethernet connection for a LAN and or Craft port connection. Connector **LAN** provides a standard RJ45 shielded receptacle connection for a standard Cat-5 connection to the controller's 10/100Base-T port. This port has two main modes of operation: Server mode, LAN mode (Static and DHCP Client). In server mode the port can be used as a local Craft interface. In this mode, a local laptop can be connected through **LAN** and its standard web browser used to directly access the controller by typing in network address omnionpower.com. A connection should never be made between the controller and LAN while the controller is in Server mode.

In Static or DHCP Client modes of operation the controller is supplied an IP address and other network parameters and can be remotely monitored and accessed through the LAN. This is generally a permanent connection between the controller and LAN so a Shielded Cat-5 cable is suggested. Use appropriate routing techniques to connect the controller to the LAN.

Default Passwords are **OmniOn**, **super-user** and **administrator**.

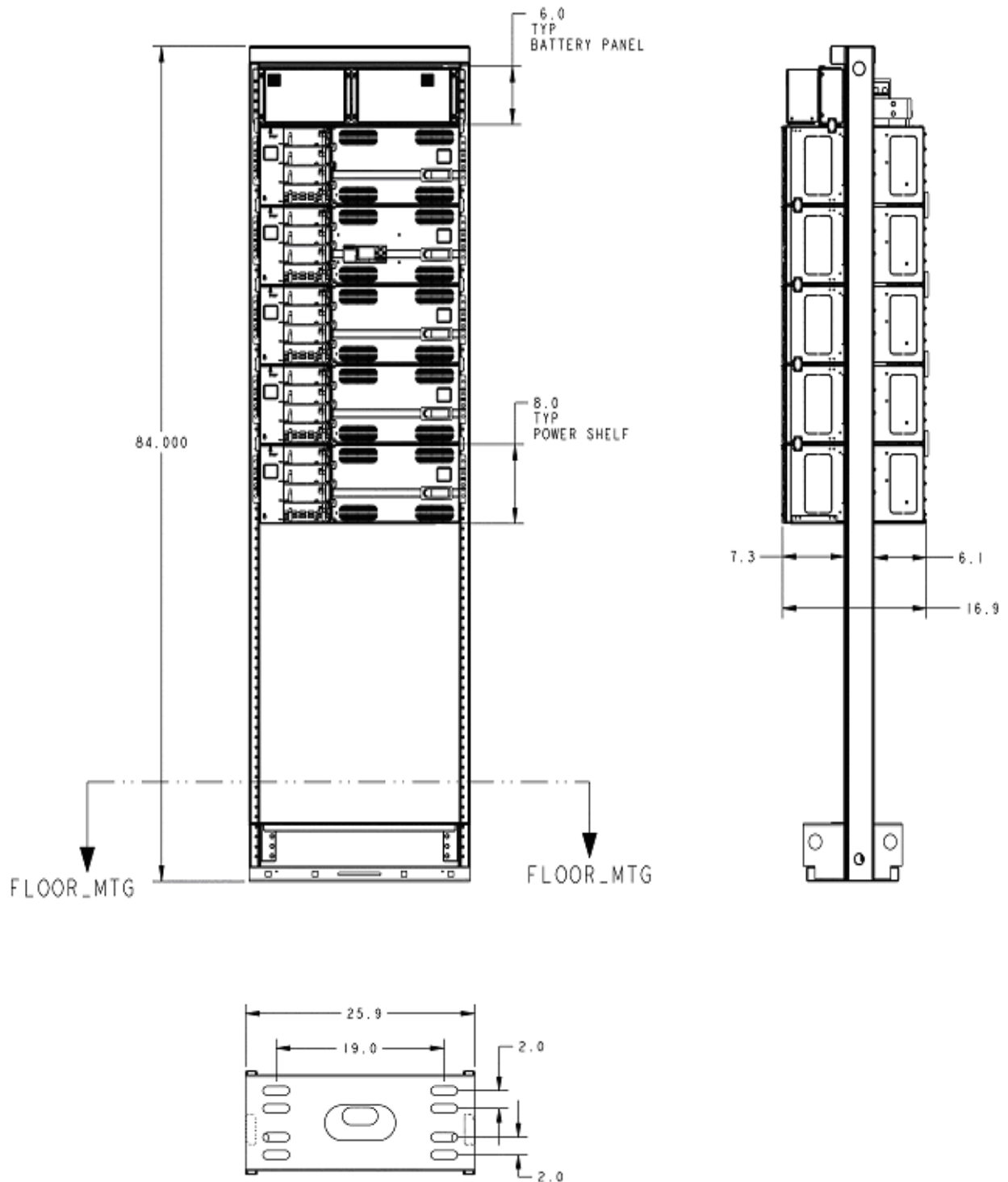

Reference Information for 26 inch Frame
(all dimensions in inches)

Revision History

Issue 0.2

February 15, 2008 – Initial release for review.

Issue 1.0

March 10, 2008 – Initial release for FOA.

Issue 1.1

March 18, 2008 – Improved images. Added details for restoring Client mode.

Issue 2.0

June 4, 2009 – Added details for dual feed AC input and GMT orientation information. Added Safety section updates; Specified 20A and 40A circuit breakers in AC wiring section; changed colors of AC wires from white to black to avoid confusion; indicated that alarm wire set conductors are paired; added passwords for LAN access.

Issue 2.1

December 4, 2023 – Updated as per OmniOn template

OmniOn Power Inc.

601 Shiloh Rd.
Plano, TX USA

omnionpower.com

We reserve the right to make technical changes or modify the contents of this document without prior notice. OmniOn Power does not accept any responsibility for errors or lack of information in this document and makes no warranty with respect to and assumes no liability as a result of any use of information in this document.

We reserve all rights in this document and in the subject matter and illustrations contained therein. Any reproduction, disclosure to third parties or utilization of its contents – in whole or in parts – is forbidden without prior written consent of OmniOn Power. This document does not convey license to any patent or any intellectual property right. Copyright© 2023 OmniOn Power Inc. All rights reserved.