

## DATASHEET

# CC7500L3B75TEZ, High-Efficiency Water-Cooled Rectifier

**3 $\phi$ , 3-Wire Input; 7500W Capable, wide output range: 65-80V<sub>DC</sub>**

**RoHS Compliant**



The CC7500L3B75TEZ is a high efficiency, true 3-phase, 3-wire (Delta) AC input, 65-80V<sub>DC</sub> output, liquid or conduction cooled rectifier power supply. The true three phase input eliminates any neutral connection and ensures tight phase current balancing. The rectifier achieves very high efficiency, reducing the cooling demands and providing beneficial OpEx savings. The rectifier meets world-wide safety, environmental, and regulatory requirements. The physical package is designed to allow very flexible for embedding into system cabinets, or for mounting on electrical panel boards. The rectifier can be mounted in both horizontal and vertical orientations, and its thin profile allows for minimal width when mounted vertically along cabinet's sides, or maximum stacking density when mounted horizontally.

## Applications

- Laser
- Industrial systems

## Features

- Efficiency 95% peak
- Compact form factor with 23.6W/in<sup>3</sup> density
- Compact dimensions 218 x 54.3 x 448 mm (liquid cooled version)
- AC Input 3-wire, 3 $\phi$ , 7500W Rated Output
- Power factor correction (meets EN/IEC 61000-3-12 and EN 60555-2 requirements)
- Output voltage programmable from 65-80V<sub>DC</sub>
- Constant power 7500W from 70-80V<sub>DC</sub>
- Constant current from 65-70V<sub>DC</sub>
- Redundant, parallel operation with active load sharing
- ModBus Communication Protocol
- Field remote upgrade
- Output overvoltage and overload protection
- AC Input overvoltage and undervoltage protection
- Over-temperature warning and protection
- Redundant +5V<sub>DC</sub> @ 0.75A Standby power
- Remote ON/OFF and redundancy interlock
- Integrated liquid-cooled cold plate (option)
- Conduction cooled (option)
- Three front panel LED indicators
- UL recognized (UL1012) compliant to IP 65 rating in accordance with ANSI/IEC 60529-2020
- CE mark (with EN62477-1/IEC61207-1)
- Meets FCC part 15 subpart A, EN55032 Class A standards
- Meets EN61000 immunity and transient standards
- Dripless Liquid Quick Connects Designed for Electronics Applications

\* UL is a registered trademark of Underwriters Laboratories, Inc.

† CSA is a registered trademark of Canadian Standards Association.

‡ VDE is a trademark of Verband Deutscher Elektrotechniker e.V.

§ This product is intended for integration into end-user equipment. All CE marking procedures of end-user equipment should be followed.

(The CE mark is placed on selected products.)

\*\* ISO is a registered trademark of the International Organization of Standards

## Technical Specifications

### Absolute Maximum Ratings

Stresses in excess of the absolute maximum ratings can cause permanent damage to the device. These are absolute stress ratings only, functional operation of the device is not implied at these or any other conditions in excess of those given in the operations sections of the data sheet. Exposure to absolute maximum ratings for extended periods can adversely affect the device reliability.

Parameter	Symbol	Min	Max	Unit
Input Low line unit: No damage Continuous	$V_{IN}$	0	300	$V_{AC}$
Storage Temperature (ensure that all liquid has been removed from cooling pipes for storage temperatures < 2°C)	$T_{stg}$	-40	85	°C
Isolation voltage Input to GND (Chassis), Output and all signals(100% factory Hi-Pot tested)			2121	$V_{DC}$

### Electrical Specifications

Unless otherwise indicated, specifications apply over all operating input voltage, resistive load, and temperature conditions. To meet measurement accuracy a warm up time of 1hr may be required.

INPUT Low Line Unit (200-240V <sub>AC</sub> )						
Parameter		Symbol	Min	Typ	Max	Unit
Operating Voltage Range (3Φ delta with safety frame ground)		$V_{IN}$	176 <sup>1</sup>	200/208 220/240	275	$V_{AC}$
Frequency		$F_{IN}$	47		63	Hz
Input current per phase (maximum at $V_{IN} = 195V_{AC}$ , $W_{OUT} = 7500W$ )		$I_{IN}$			27	$A_{rms}$
Input low voltage	Turn off Turn on Hysteresis	$V_{IN}$	5		171 176	$V_{AC}$
Input high voltage	Turn off Turn on Hysteresis	$V_{IN}$	280 275 5			$V_{AC}$
Input current phase unbalance [load > 50% of FL]					6	%
Inrush Transient (per Φ at 240V <sub>RMS</sub> , 25°C, excluding X-Capacitor charging)		$I_{IN}$		65	72	$A_{pk}$
Leakage Current (per Φ, 240V <sub>AC</sub> , 60Hz)		$I_{IN}$			5 <sup>2</sup>	%
Input voltage unbalance		$V_{IN}$	-15	1	+10	%
Phase failure protection						
Line failure protection						
Power Factor (50 – 100% load)		PF	0.98	0.995		
Total Harmonic Distortion (50 – 100% load)		THD			5 <sup>3</sup>	%
Efficiency (200/200V <sub>AC</sub> @ 25°C, 73V <sub>DC</sub> output)	50% FL	$\eta$	94	95		%
Ride through ( $V_{IN} = 200V_{rms}$ , 100% FL)		T	10			ms
Isolation	Input – Output Input – Chassis(GND)/All Signals Output – Chassis (GND) LGND – Chassis (GND)	V	2000 2000 1500 100			$V_{DC}$

<sup>1</sup>Power derating at  $V_{IN} < 190V$ .

## Technical Specifications (continued)

### Electrical Specifications (continued)

<b>MAIN OUTPUT (common)</b>					
<b>Parameter</b>	<b>Symbol</b>	<b>Min</b>	<b>Typ</b>	<b>Max</b>	<b>Unit</b>
Output Power ( $T_{INLET/CASE} = 2-30^{\circ}C$ , $V_{IN} \geq 195V_{AC}$ ) $176V_{AC} \leq V_{IN} \leq 195V_{AC}$ , power derating	$W_{OUT}$			7500 6900	$W_{DC}$ $W_{DC}$
Output Voltage Factory Setpoint ( $25^{\circ}C$ )	$V_{OUT}$		73		$V_{DC}$
Output Voltage Programming Range		65		80	$V_{DC}$
Resolution			2.8		mV
Overall Output Regulation (single and paralleling operation) $T_{inlet/case} = 25^{\circ}C$ $T_{inlet/case} = 2-30^{\circ}C$		-0.5 -1%		+0.5 +1%	V
Output Current ( $T_{INLET/case} = 2-30^{\circ}C$ , $V_{IN} \geq 190V_{AC}$ ) $V_{OUT} = 80V_{DC}$ $V_{OUT} = 73V_{DC}$ $V_{OUT} = 70V_{DC}$ $V_{OUT} = 65V_{DC}$	$I_{OUT}$	0 0		93.8 102.7 107.2 107.2	$A_{DC}$
Output Ripple (20MHz bandwidth) RMS (5Hz to 20MHz) Peak-to-Peak (5Hz to 20MHz)	$V_{OUT}$			120 500	$mV_{rms}$ $mV_{p-p}$
Current share (>50% FL)		-5		+5	%FL
External Bulk Load Capacitance				20	mF
Turn-On (monotonic from 30-100% of $V_{nom}$ ) AC input turn on Delay Remote enable turn on delay Rise Time Output Overshoot	T    $V_{OUT}$		5 0.2 120		s ms %
Pulse load response, $25^{\circ}C$ , no shutdown/damage happen Load frequency Duty Load step	F Duty $I_{OUT}$	1 10 1		10K 50 100	Hz % % FL
Power limit, $V_o$ from 70-80 $V_{DC}$	$W_{OUT}$	7500			$W_{DC}$
Current limit, $V_o$ from 65-70 $V_{DC}$	$I_{OUT}$	105			%
Undervoltage Shutdown	$V_{OUT}$		63		$V_{DC}$
Short-circuit protection	No damage				
Overvoltage Shutdown (dynamic)  200ms delayed shutdown (default) Immediate shutdown Programmable range Latched shutdown Restart delay	$V_{OUT}$		$V_{o,set} + 5$		$V_{DC}$
	After 3 restart attempts within a 30 sec window, unit latches OFF				
		3.5	4	5	sec
Over-temperature Warning (prior to commencement of shutdown) Shutdown (below the max device rating being protected) Restart attempt Hysteresis (below shutdown level)	T		5 20 20		$^{\circ}C$
Restart/Reset conditions	Loss of input > 100ms or Output OFF followed by ON command				
Isolation voltage to Chassis/signals	2100 $V_{DC}$				

<b>5V<sub>DC</sub> Auxiliary output</b>					
<b>Parameter</b>	<b>Symbol</b>	<b>Min</b>	<b>Typ</b>	<b>Max</b>	<b>Unit</b>
Output Voltage Setpoint	$V_{OUT}$		5		$V_{DC}$
Overall Regulation		-10		+10	%
Output Current		0		0.75	A
Over - voltage Clamp					$V_{DC}$
Over - current Limit					%FL
Isolation voltage to main output					$V_{DC}$
Isolation voltage to grounding/chassis				100	$V_{DC}$

## Technical Specifications (continued)

### Pulse load transient requirement (single unit)

Unit meets the following pulse load transient minimum requirements.

Parameter	Symbol	Min	Typ	Max	Unit
Pulse Frequency		1		10	KHz
Pulse duty		1		99	%
Co in load side			2.25/6720		mohm/ uF
Cable size:MX2-1/4			2		AWG
Cable length from output to load			700		mm
Case A: Pulse load @ 1Hz-2KHz (worse case 100A/200us = 0.5A/us) Pulse Duty Vo peak deviation Max Pulse Duty @ 2KHz, as period time is 500us		1.5  1	  73+/-1.5 25	95  99	A  % V %
Case B: Pulse load @ +2KHz (worse case 35A/80us = 0.4A/us) Vo peak deviation		15	  73+/-1.5	50	A  V

Io measurement is between PSU and fiber laser (as load); Vo measurement is on PSU output side.

Measure Vo peak deviation from the first pulse load applied.

### Pulse load transient requirement (3pcs unit in paralleling)

To meet specific application with pulse load transient, Unit should meet below requirement.

Parameter	Symbol	Min	Typ	Max	Unit
Pulse Frequency		1		10	KHz
Pulse duty		1		99	%
Vo peak deviation @ 1.8A - 275A			+/-1.5		V
Recovery time				10	ms
Cable size:MX2-1/4, 700mm			2		mm
Cable length from output to load			700		mm
Case A: Pulse load @ 1Hz - 2KHz		5		285	A
Pulse Duty		1		99	%
Vo peak deviation		76+/-1.5		80+/-1.5	V
Max Pulse Duty @ 2KHz, as period time is 500us			25		%
Case B: Pulse load @ +2KHz		45		150	A
Vo peak deviation		76+/-1.5		80+/-1.5	V

Typical Total Co is 3 x 6720  $\mu$ F in load side. Vo measurement is on PSU output side. Measured Vo peak deviation from the first pulse load applied.

## Technical Specifications (continued)

### Vo discharging requirement (single unit)

When unit is turned off by Enable signal, the Vo discharge time (From Vo begin to drop to 3V is less than 33sec, test with 6270uF external Co, no load condition.)

### General Specifications

Parameter	Min	Typ	Max	Units	Notes
Unpacked Weight (conduction cooled)		7.68 (16.9)		Kgs (Lbs)	
Packed weight (conduction cooled)		9.14 (20.1)			
Unpacked Weight (liquid cooled)		7.91 (17.4)			
Packed weight (liquid cooled)		9.36 (20.6)			
Reliability Calculated		560,000		Hours	Full load, 25°C case; MTBF per Telecordia SR232 Reliability protection for electronic equipment, issue 3, method I, case III,
Service life		10		years	Case temperature, 25°C, 80% load

### Signal Specifications

Unless otherwise indicated, specifications apply over all operating input voltage, resistive load, and temperature conditions. Signals are referenced to Logic\_GRD unless noted otherwise. See the Signal Definitions table for additional information.

Parameter	Symbol	Min	Typ	Max	Unit
<b>Remote ON/OFF</b> (should be connected to Logic_GRD) main output OFF	V <sub>OUT</sub>	2.5	–	50	V <sub>DC</sub>
		0	–	0.8	
V <sub>prog</sub> Voltage control range Programmed output voltage range Voltage adjustment resolution (12-bit A/D) Output configured to 73V <sub>DC</sub> <sup>2</sup> Output configured to 65V <sub>DC</sub>	V <sub>control</sub>	0	6	3.3	V <sub>DC</sub>
	V <sub>OUT</sub>	65		80	V <sub>DC</sub>
	V <sub>control</sub>	3.15		3.3	mV <sub>DC</sub>
	V <sub>control</sub>				
	V <sub>control</sub>				
<b>Fault</b> (open collector output, pulled up with a 4.7kohm resistor inside, 24V need to be sourced externally)					
Logic HI (No fault is present)	V	–	–	50	V <sub>DC</sub>
Sink current	I	–	–	5	mA
Logic LO (Fault is present)	V	0	–	0.4	V <sub>DC</sub>
<b>Power Good</b> (open collector output, pulled up with a 4.7kohm resistor inside, 24V need to be sourced externally)					
Logic HI (Vo in regulation – normal)	V			50	V <sub>DC</sub>
Sink current	I			5	mA
Logic LO (Alert is set)	V	0		0.4	V <sub>DC</sub>
<b>EMG</b> (open collector output, pulled up with a 4.7kohm resistor inside, 24V need to be sourced externally)				50	V <sub>DC</sub>
Logic HI (both Interlocks open)	V			5	mA
Sink current	I			0.4	V <sub>DC</sub>
Logic LO (normal)	V				
<b>Interlock 1</b> (Opto-coupler input, 1K ohm resistor in series inside) Conduction current to turn on		3		6	mA
<b>Interlock 2</b> (Opto-coupler input, 1K ohm resistor in series inside) Conduction current to turn on		3		6	mA

<sup>2</sup>default setting can be changed through Modbus command by user, and stored into non-volatile memory.

## Technical Specifications (continued)

### Environmental Specifications

Parameter	Min	Typ	Max	Units	Notes
Coolant Water Inlet Temperature <sup>3,4</sup>	2		30	°C	
Operating Ambient Air Temperature	2		50	°C	
Cooling Flow Rate	0.13 0.5		0.66 2.5	GPM L/min	
Cold Plate Inlet Pressure	30		100	psi	
Cold Plate Pressure Drop		10		psi	at the typical flow rate
Conduction cold-plate temperature	2		30	°C	
Operating Altitude			3000 / 10k	m / ft	
Non-operating Altitude			9000 / 30k	m / ft	
Shock	Operational	IEC 60068-2-27			
Vibration	Operational	IEC60068-2-64			

### EMC [Surges and sags applied one $\Phi$ at a time and all $3\Phi$ 's simultaneously; phase angles 0°, 90°, 270°]

Parameter	Function	Standard	Level	Criteria	Test
AC input	Conducted emissions	EN55032, FCC part 15	A		0.15 – 30MHz
	Radiated emissions <sup>5</sup>	EN55032/CISPR32, FCC part 15 Subpart A,	A		30 – 10000MHz
	Input Harmonics	IEC61000-3-12 THD	A 5%		
AC Input Immunity	Line DIP and Short interruptions	IEC61000-4-34 Dip	Class 3	B	-30% (from nominal) for 25/30 cycles -100%, 1 cycle
		IEC61000-4-34 short interruption	Class 3	B	25% sag from nominal for 250/300 cycles
				A	1/2 cycle -100% interruption
	Lightning surge	EN61000-4-5, Level 4, 1.2/50 $\mu$ s – error free		A	4kV L-E
				A	2kV L-L
Fast transients	EN61000-4-4	3	A	5/50ns, 2kV (common mode)	
Enclosure immunity	Conducted RF fields	EN61000-4-6	3	A	140dB $\mu$ V, 0.15-80MHz, 80% AM
	Radiated RF fields	EN61000-4-3	3	A	10V/m, 80-1000MHz, 80% AM
	ESD	EN61000-4-2	4	A	8kV contact, 15kV air
	Magnetic Field Immunity	EN61000-4-8	4	A	

#### Criteria Performance

- A No performance degradation
- B Temporary loss of function or degradation not requiring manual intervention
- C Temporary loss of function or degradation that may require manual intervention
- D Loss of function with possible permanent damage

<sup>3</sup>Coolant must remain free of algae and corrosion products. The use of suitable inhibitors in the coolant is recommended and compatible with copper tubing. Full-rated output power is available up to 30°C inlet water temperature (lower for coolants other than water).

<sup>4</sup>Water connections are indicated by color on faceplate (blue – cool inlet, red – warm exit). Water delivery method should include strain relief feature to mitigate the risk of water leak in the end product. Leak detection and protection mechanisms should be used to mitigate the effect of water leaks. Care must be taken to prevent water clogs that could reduce the water pressure or restrict flow.

<sup>5</sup>Test with system. For improved performance you may consider adding ferrite cores to the AC Input and DC output cables.

# Technical Specifications (continued)

## Control and Status

The Rectifier provides two methods for monitor and control, analog and the ModBus protocol.

## Signal Reference

Unless otherwise noted, all signals, the standby output, and Modbus communications are referenced to Logic\_GRD. See the Signal Definitions Table at the end of this document for further description of all the signals.

Logic\_GRD is capacitively coupled to Frame\_GRD inside the rectifier. The maximum voltage differential between Logic\_GRD and Frame\_GRD should be less than 100V<sub>DC</sub>. It is assumed that the end user will connect Logic\_GRD to his digital ground reference in his system.

Logic\_GRD is isolated from the main output of the rectifier.

## Control Signals

**Interlock 1 & 2:** These two pins provide redundant emergency stop function. Either interlock pin open will turn off main output immediately within 50 ms(at full load), faster than normal Enable control. Only both interlocks signals conducted and Enable logic low can turn on main output.

LED/analog signals/communication can report status correctly when interlock is open.

Interlock is top priority no matter Enable/Modbus command status.

**Enable:** Generic remote on/off main output with system control. Logic low to turn on main output and Logic High to turn off in 100-200ms.

Refer the on/off logic table combined interlock and Enable.

Input	Interlock 1#	OFF (Open)	ON	OFF	ON	ON
	Interlock 2#	OFF	OFF	ON	ON	ON
	Enable	ON/OFF	ON/OFF	ON/OFF	ON	OFF
Output	EMG	HI	HI	HI	LOW	LOW
	PG	LOW	LOW	LOW	High	LOW
	Output voltage	OFF	OFF	OFF	ON	OFF

**Voltage programming (V<sub>prog</sub>):** Hardware voltage programming controls the output voltage until a software command to change the output voltage is executed. Software voltage programming permanently overrides the hardware margin setting and the rectifier no longer listens to any hardware margin settings until power to the controller is interrupted, for example if input power or bias power is recycled.

When bias power is recycled to the controller the controller restarts into its default configuration, programmed to set the output as instructed by the V<sub>prog</sub> pin. Again, subsequent software commanded settings permanently override the margin setting. As an example, applying a voltage between V<sub>prog</sub> and Logic\_GRD is an effective way of changing the factory set point of the rectifier to whatever voltage level is desired by the user during initial start-up.

The V<sub>prog</sub> pin level should be set by a divider from 3.3V<sub>DC</sub> to Logic\_GRD external to the rectifier as shown in the graph. Programming can be accomplished either by a resistor divider or by a voltage source injecting a precision voltage level into the V<sub>prog</sub> pin. Above 3V<sub>DC</sub> the rectifier sets the output to its default state.

If V<sub>prog</sub> feature is not used, keep this pin open. this signal is pulled up to 3.3V with a resistor inside, therefore output voltage is default factory setting.

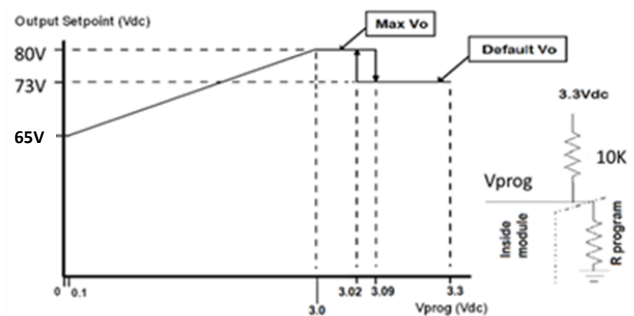

## I<sub>share</sub> (after P0 stage)

**Load share (I<sub>share</sub>):** This is a single wire analog signal that is generated and acted upon automatically by rectifiers connected in parallel. I<sub>share</sub> pins should be connected to each other for rectifiers, if active current share among the rectifiers is desired. No resistors or capacitors should get connected to this pin. I<sub>share</sub> refers Vo- as ground.



## Technical Specifications (continued)

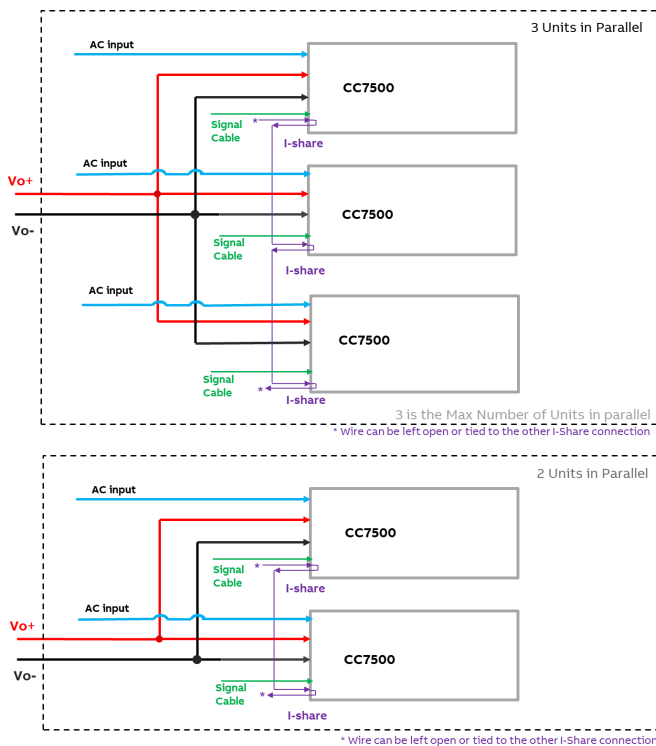

### Status Signals

**EMG:** This signal represents the status of interlocks input. This signal is pulled up with a 4.7kohm resistor inside, 24V needs to be sourced outside the rectifier. Only when both interlocks input open will cause this signal to HI status.

**PG#:** This signal is HI when the main output is delivered and goes LO if the main output is out of regulation. This signal is pulled up with a 4.7kohm resistor inside, 24V needs to be sourced outside the rectifier.

**Fault#:** This signal representing whether a Fault occurred. This signal is pulled up with a 4.7kohm resistor inside, 24V needs to be sourced outside the rectifier. This signal goes LO for any failure.

### Communication

CC7500 supports Modbus communication to control and monitor the device. It also supports firmware remote upgrade.

Refer to the Modbus Communication Protocol Feature Document Issue 0.1 for details.

#### Modbus Physical layer:

Modbus over a serial line should implement an electrical interface in accordance with EIA/TIA-485 standard (also known as RS485). This standard allows point to point and multipoint systems, in a “two-wire configuration”.

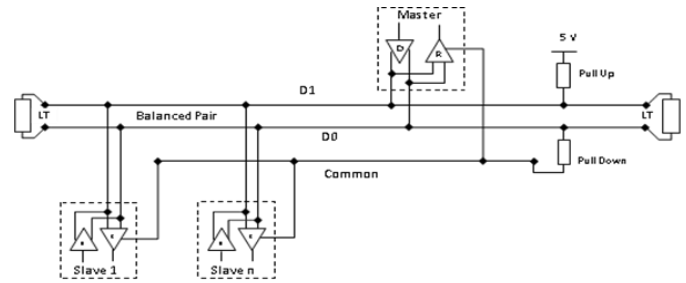

Hardware signal pin named “Modbus+” is presented as “D1” and “Modbus-” as “D0”.

#### Modbus mode

Supports RTU mode

#### Modbus Addressing

The Modbus addressing space comprises of 99 different addresses.

0	From 1 to 99
Broadcast address	Slave individual addresses

Address 0 is reserved as the broadcast address and all slave nodes must recognize the broadcast address.

The Modbus master node has no specific address and only the slave nodes require an address. The address must be unique on the Modbus serial line.

The address is set through signals Addr\_0 and Addr\_1.

#### Addr\_0 to Addr\_1

Treat the Addr\_0 pin as a ones place and Addr\_1 as a tens place to make up the unit’s address. Each address pin is pulled up to an internal 3.3V through a 10K ohm resistor. The external resistor,  $R_s$ , connected to LGND changes the voltage level to configure the address according to the table below.

Tens or one place	Voltage level	$R_s$ (+/-1%)
1	3.30	open
2	2.67	45.3k
3	2.34	24.9k
4	2.01	15.4k
5	1.68	10.5k
6	1.35	7.15k
7	1.02	4.99k
8	0.69	2.49k
9	0.36	1.27k
0	0	0

For example, if we want to set the address to 10d, use Addr\_1 to set tens digit to 1 by leaving  $R_s$  open. Then use Addr\_0 to set ones digit to 0 by setting  $R_s$  to 0 ohm.

The default address is 11d, when address pins are left open.



## Technical Specifications (continued)

### Remote upgrade

CC7500 supports to upgrade firmware on live through Modbus.

### LEDs

Three LEDs are located on the front faceplate of the device. The AC\_OK LED provides visual indication of the INPUT signal function. When the LED is ON and GREEN, the rectifier input is within normal design limits.

The second LED is the DC\_OK LED. When is it SOLID GREEN, the DC output is present. When 'blinking', a power limit or overload condition exists. When it is OFF, the output is not present.

The third LED is the FAULT LED. A SOLID RED condition indicates that a fault exists and the rectifier has been shut down. A 'blinking' RED LED indicates an over-temperature warning.

Both FAULT LED and DC\_OK LED 'blinking' indicates an interlock is OPEN.

A communication fail alert is enabled after communications is established. If during power up, communications is not sensed, then the communication fail alert can not be asserted. If at any time during operation there is communications established, then the communication fail alert can occur if communication is lost.

There is a communication fail alert timeout default of 30 seconds, where if communications has been established and the device does not communicate for 30 seconds, the communication fail alert will assert. This timeout can be changed via a Modbus register. The communication fail alert feature can also be enabled/disabled via a Modbus register, if you do not want a timeout/comm fail to be detected.

### Alarm and LED state summary

Condition	Power Supply LED State			Signals State		
	AC OK Green	Fault Red	DC OK Green	Fault	PG	EMG
OK	1	0	1	High	High	LOW
Over-Temperature Warning (OTW) 5°C before shutdown)	1	Blinks	1	LOW	High	LOW
Over temperature Shutdown	1	1	0	LOW	LOW	LOW
AC Present but not within limits	Blinks	0	0	High	LOW	LOW
Boost Stage Failure	1	1	0	LOW	LOW	LOW
Over Voltage Latched Shutdown	1	1	0	High	LOW	LOW
Over Current	1	0	Blinks	High	Pulse	LOW
Non-catastrophic Internal Failure	1	1	1	LOW	High	LOW
Standby (remote enable/communication command)	1	0	0	High	LOW	LOW
Emergency stop (only one interlock open)	1	Blinks	Blinks	High	LOW	LOW
Emergency stop (both interlocks open)	1	Blinks	Blinks	High	LOW	High
Comm. Fail (loss of Comm.)	1	Blinks	1	High	High	LOW

## Technical Specifications (continued)

### Front view

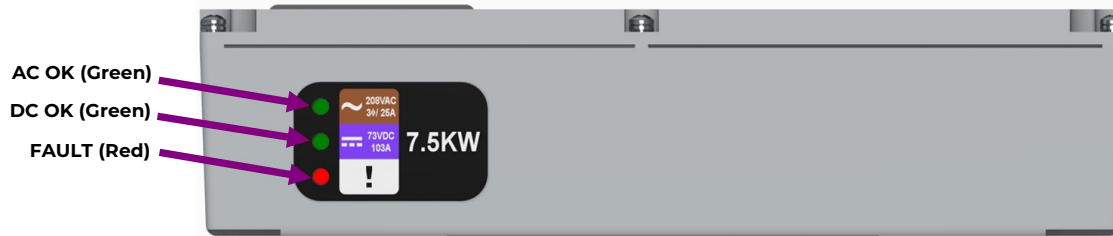

### Rear view

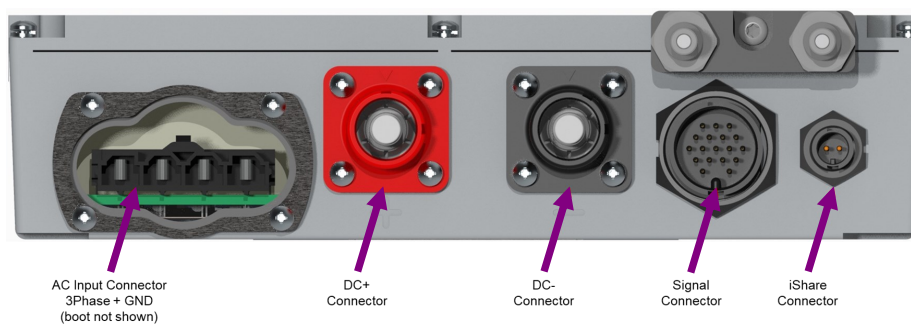

**Connectors without mated pairs, covers and cables.**

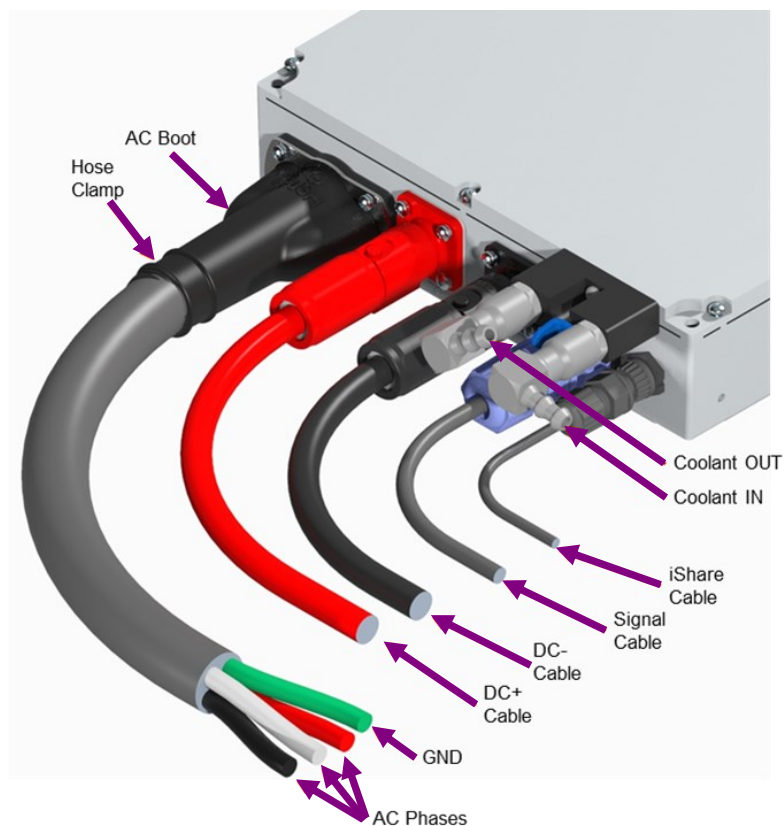

**Connectors with mated pairs, AC boot and cables**

## Technical Specifications (continued)

### AC Input connector

Installed AC connector is Molex Mini-fit Sr, [Molex 042820-4224](#), Rated for 8AWG and 50A.

Mating connector is [Molex 042816-0412](#).

A plastic cover is provided to provide water protection.

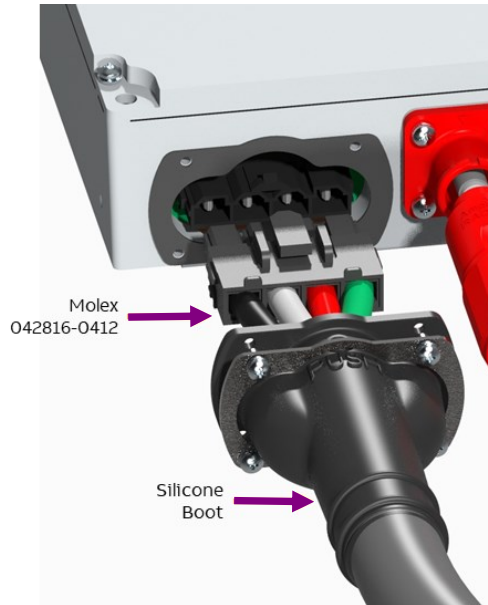

### DC Output connector

DC connectors on rectifier are Amphenol Surlok waterproof connectors, SLPIRBTPSR0, Red, 90deg key, and SLPIRBTPSB2, Black, 60deg key.

Mating connectors are Amphenol SLPIB35BSR0, Red, 90deg key, and SLPIB35BSB2, Black, 60deg key. They support 2 AWG wire field termination using standard crimping tools.

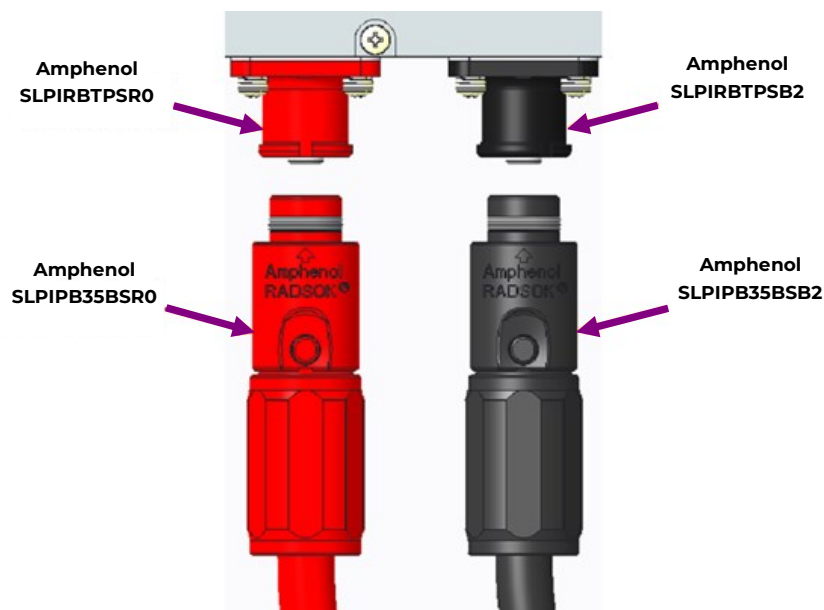

## Technical Specifications (continued)

### Signal & Current-Share Connectors

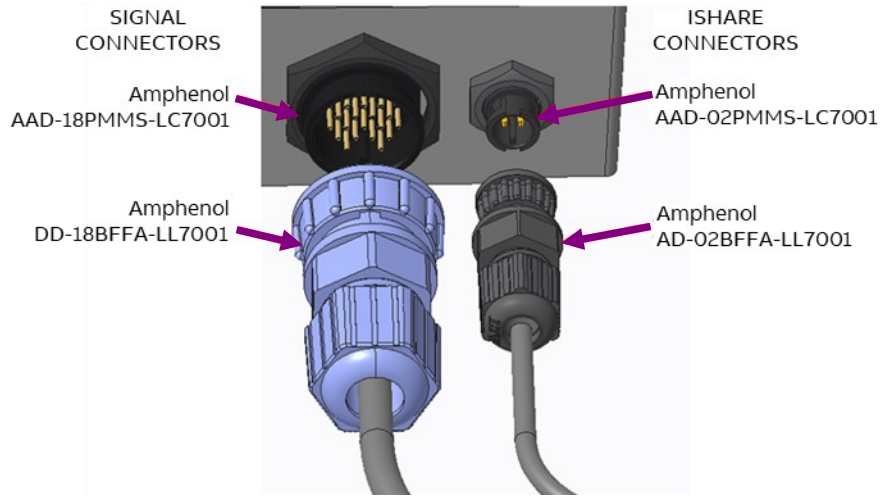

Connector	Pin	Label	Type	Description
I-Share	1	ISHARE		A single wire active-current-share interconnect between rectifiers Ref: Vout (-)
	2	ISHARE		

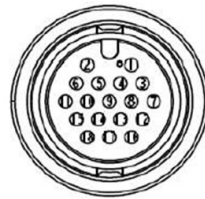

MATING FACE

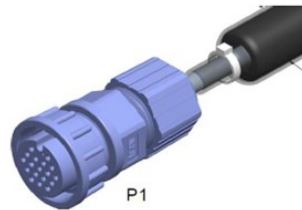

P1

Signal cable (Ordering code: 1600447136A)

### Water connections

The rectifier uses dripless liquid quick-connects for the cold plate connections. They are male CPC Everis LQ2 fittings, LQ2D4604BLU and will interface with any female CPC Everis LQ2 fitting.

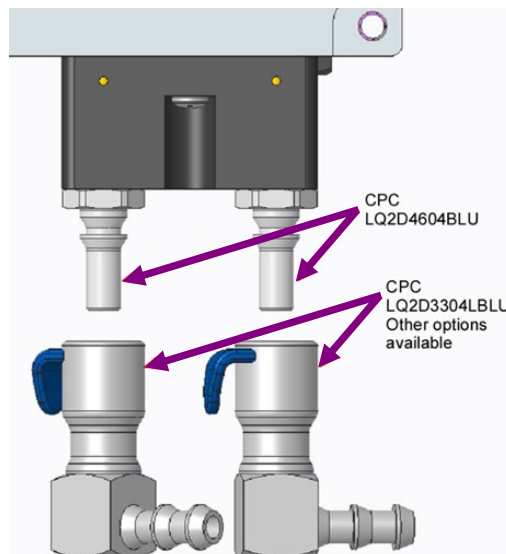

## Technical Specifications (continued)

### Signal table

Connector	Pin	Label	Type	Description
Signal	1	Modbus+		Modbus communication wire DI, refer to LGND
	2	Modbus-		Modbus communication wire DO, refer to LGND
	3	LGND	Reference ground	Isolated from the main output & SEC_RTN.
	4	5Vstby	Output	5V @ 0.75A provided for external use; return is LGND. This output is always ON.
	5	Vprog	Input	Vo programming
	6	Addr_0	Input	Address setting
	7	Addr_1	Input	Address setting
	8	Intrick_1	Input	Emergency stop to turn OFF the main output within 50ms. Open (not connected) turns OFF; 3mA (min) to 6mA (max) into the pin turns ON. The internal circuit is an opto-isolator diode (~1.1V) with 1000 ohms in series to LGND, so supplying an external voltage of 4.1-7.1V (5V for example) turns ON. A higher external voltage may be used with a current-limiting resistor in series.
	9	Intrick_2	Input	Emergency stop to turn OFF the main output within 50ms Open (not connected) turns OFF; 3mA (min) to 6mA (max) into the pin turns ON. The internal circuit is an opto-isolator diode (~1.1V) with 1000 ohms in series to LGND, so supplying an external voltage of 4.1-7.1V (5V for example) turns ON. A higher external voltage may be used with a current-limiting resistor in series.
	10	Enable	Input	Turns the main output ON/OFF. Open (not connected) turns OFF; 3mA (min) to 6mA (max) into the pin turns ON. The internal circuit is an opto-isolator diode (~1.1V) with 1000 ohms in series to LGND, so supplying an external voltage of 4.1-7.1V (5V for example) turns ON. A higher external voltage may be used with a current-limiting resistor in series.
	11	-		
	12	PG	Output	V <sub>o</sub> is in regulation Open-collector type, pulled up internally to VCC_ext. Sink current is 5mA max max voltage is VCC_ext. Normal is logic Hi.
	13	FAULT	Output	Internal fault - see table p.11. Open-collector type, pulled up internally to VCC_ext. Sink current is 5mA max, max voltage is VCC_ext. Normal is logic High.
	14	EMG	Output	“Emergency” interlock status: Logic Low when both interlocks are satisfied (= ON = powered). Pulled up internally to VCC_ext.
	15	VCC_ext	Input	External pull-up voltage for output signals, referred to LGND and connected to internal 5K pull-up resistors. Set less than the maximum input voltage of connected devices, and < 30V abs max.
	16	-	-	
	17	-	-	
	18	-	-	
* Alternate function				
	11	Fault_1	Output	Bit 1 of a 3-bit fault code – see table p.11. Open-collector type, pulled up internally to VCC_ext
	13	Fault_2	Output	Bit 2 of a 3-bit fault code – see table p.11. Open-collector type, pulled up internally to VCC_ext
	16	Fault_3	Output	Bit 3 of a 3-bit fault code – see table p.11. Open-collector type, pulled up internally to VCC_ext
I-Share	1	ISHARE		A single wire active-current-share interconnect between rectifiers Ref: Vout (-)
	2	ISHARE		

## Technical Specifications (continued)

### Modbus Registers

All registers in this document are 0-based. Holding register 40001 is addressed as 0001 in a Modbus message.

Reg Address	Reg length (word)	Register Name	R/W	Reg type	Note
1	18	SERIAL_NUMBER	R/W	STR18	
19	1	GROUP_ADDRESS	R/W	INT	
20	11	COMCODE	R/W	STR11	
31	20	STATION_TYPE_R	R	STR20	
51	7	SERIES	R/W	STR7	XX: YYZ, XX YY is 0-9, Z is A-Z
58	7	SEC_APPLICATION_VERSION	R	STR7	VERmaj, VERmin, Month, Day, Year, Hour, Minutes
65	7	PRI_APPLICATION_VERSION	R	STR7	VERmaj, VERmin, Month, Day, Year, Hour, Minutes
72	10	CLEI_NUMBER	R	STR10	
82	1	CAPACITY	R	INT	Current capacity of rectifier (A x 10)
84	2	ON_TIME	R	INT	In hours
301	1	RECT_STATUS	R		Device Status 0001h: 1 = oring FET failed 0002h: 1 = AC input failure 0004h: Not Used 0008h: 1 = Rectifier shutdown due to thermal alarm 0010h: 1 = Rectifier failure 0020h: Not Used 0040h: 1 = Load share imbalance 0080h: 1 = Participating in load share (Enabled) 0100h: Manual Off, 1 = Manually OFF 0200h: 1 = Standby from controller requested 0400h: 1 = Rectifier shutdown due to high voltage 0800h: Rectifier Power Status, 1 = On and producing power 1000h: 1 = Ready to participate in load share 2000h: 1 = ID # has changed (cleared when read) 4000h: 1 = Fan failed 8000h: 1 = Rectifier is in current limit/Power Limit
500	1	VIN_RMS_A	R	INT	Input voltage phase A in VIN_RSU
501	1	VIN_RMS_B	R	INT	Input voltage phase B in VIN_RSU
502	1	VIN_RMS_C	R	INT	Input voltage phase C in VIN_RSU
503	1	IIN_RMS_A	R	INT	Input current phase A in IIN_RSU
504	1	IIN_RMS_B	R	INT	Input current phase B in IIN_RSU
505	1	IIN_RMS_C	R	INT	Input current phase C in IIN_RSU
506	1	AC_POWER_ALL	R	INT	Input power all phases in PIN_RSU
523	1	VCATHODE (volts)	R	INT	Output voltage in VOUT_RSU
524	1	VANODE (volts)	R	INT	Output voltage in VOUT_RSU
527	1	OUTPUT CURRENT	R	INT	Output current in IOUT_RSU
529	1	OUTPUT POWER	R	INT	Output Power in Watts

## Technical Specifications (continued)

### Modbus Registers (continued)

Reg Address	Reg length (word)	Register Name	R/W	Reg type	Note
531	1	TEMP_INTERNAL (hottest)	R	INT	Hottest Temperature in TEMP_RSU (Celsius)
532	1	TEMP_DCDC	R	INT	Temperature in TEMP_RSU (Celsius)
533	1	TEMP_PFC	R	INT	Temperature in TEMP_RSU (Celsius)
534	1	TEMP_SYNC	R	INT	Temperature in TEMP_RSU (Celsius)
535	1	TEMP_ORFET	R	INT	Temperature in TEMP_RSU (Celsius)
536	1	TEMP_AMBIENT	R	INT	Temperature in TEMP_RSU (Celsius)
803	1	CMD_ALL	R/W		00 01h Standby 00 02h Unit On 00 04h HV Shutdown 00 08h Loadshare On 00 10h Loadshare Off 00 20h Restart 00 40h Lamp Test 00 80h 01 00h Fault LED On 02 00h Fault LED Off 04 00h Oring FET Test 08 00h 10 00h 20 00h 40 00h 80 00h
850	1	VIN_RSU_R	R		Readback scaling factor for input voltage
851	1	IIN_RSU_R	R		Readback scaling factor for input current
852	1	PIN_RSU_R	R		Readback scaling factor for input power
853	1	FIN_RSU_R	R		Readback scaling factor for input frequency
854	1	VBUS_RSU_R	R		Readback scaling factor for bus voltage
860	1	VOUT_RSU_R	R		Readback scaling factor for output voltage
861	1	IOUT_RSU_R	R		Readback scaling factor for output current
862	1	POUT_RSU_R	R		Readback scaling factor for output power
870	1	TEMP_RSU_R	R		Readback scaling factor for temperature
904	1	VSET	R/W	INT	Vout set-point (non-volatile memory) in VOUT_RSU
905	1	VCMD	R/W	INT	Vout set-point (volatile memory) in VOUT_RSU
920	1	CL_PERCENT	R/W	INT	Current limit set point in % of rectifier capacity. Configurable from 30 to 100.
922	1	ISHVSD	R/W	INT	Individual selective high voltage shutdown in VOUT_RSU
1100	1	COMM_LOSS	R/W	UINT	In seconds
1101	1	COMM_LOSS TIMEOUT_DISABLE	R/W	INT	Write 1 to disable, write 0 to enable (default is enabled)



## Technical Specifications (continued)

### Byte format:

The format (11 bits) for each byte in RTU mode is:

**Coding System:** 8-bit binary

**Bits per Byte:** 1 start bit, 8 data bits, 1 parity bit, 1 stop bit

**Parity:** even

**Baud:** 19200

### Supported Function Codes

0x03: Read Holding Registers

0x06: Write Single Holding Register

0x10: Write Multi Holding Register

### References

1. "Galaxy Communication Protocol Feature Document" (99ESS001) Ver 2.19 Team
2. Modbus application protocol V1.1b3
3. [Modbus Serial Line Protocol and Implementation Guide V1.02](#)
4. OmniOn ACS510 low voltage AC drivers User manual
5. OmniOn AC500 PLC user manual

### Standard Modbus Exception Codes

Code	Name	Description
1	Illegal Function	The function code received in the query is not an allowable action for the slave. If a Poll Program Complete command was issued, this code indicates that no program function preceded it.
2	Illegal Data Address	The data address received in the query is not an allowable address for the slave.
3	Illegal Data Value	A value contained in the query data field is not an allowable value for the slave.

# Technical Specifications (continued)

## Mechanical Drawing

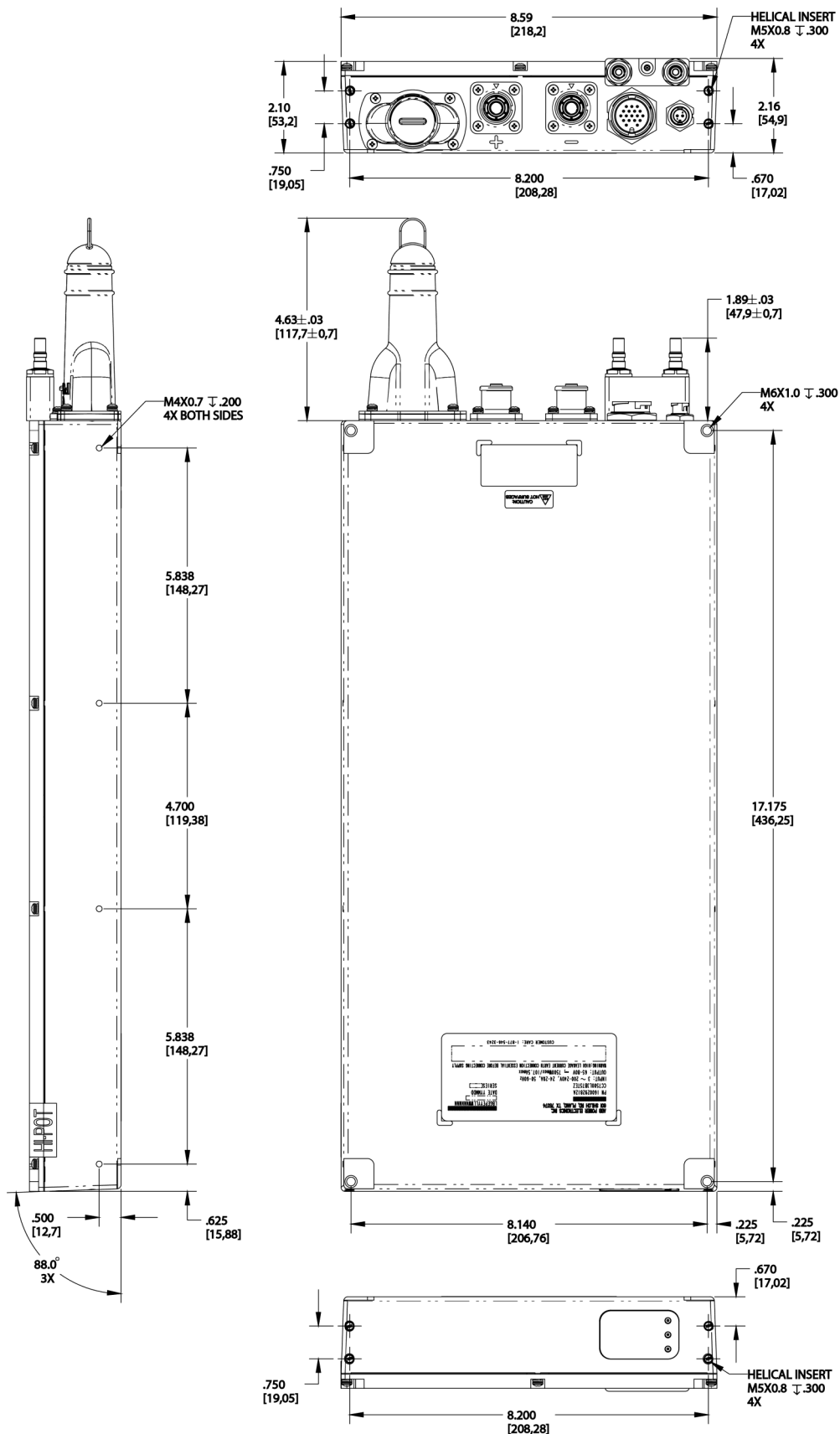

# Technical Specifications (continued)

## Accessories

Item	Description	Ordering code	
	AC Cable	3ph Delta with Ground, 8AWG, 311mm	1600447138A
	DC Cable	Surlok, Red/Black pair, 2AWG, 311mm	1600447137A
	Signal Cable	ModBus and Alarms, 412mm, 24AWG, with Integrated EMI filter	1600447136A
	Share Cable	Load Share, 311mm, 22AWG	1600447322A
	Digital Power Insights – ModBus Developers Toolkit	ModBus Adaptor, Interface Board, Downloadable GUI and Instructions (Requires Signal Cable 1600447136A Purchased separately)	1600464989A

## Ordering Information

Please contact your OmniOn Sales Representative for pricing, availability and optional features.

Item	Description	Ordering code
CC7500L3B75TEZ	7500W 200-240V <sub>AC</sub> to 73V <sub>DC</sub> Rectifier, water cooled	1600292812A

## Change History (excludes grammar & clarifications)

Revision	Date	Description of the change
13	02/16/2023	Changed to OmniOn template and updated safety standards
13.1	04/28/2023	Updated Product image, Updated UL compliant in feature section, Added value for sink current in signal table, Added image for water connections, AC & DC connectors, Signal & Current-Share Connectors, product front /rear views are updated. Updated images and ordering codes for AC Cable, DC Cable, Signal cable and Share Cable.
13.2	05/26/2023	Removed High line input section, Range of Output voltage (Vo) change from 60 to 65V <sub>DC</sub> in main output section and in signal specifications.
13.3	06/09/2023	Updated mechanical drawing, Removed Amada references, Updated description content on cover page, Updated tolerance of Rs in Addr_0 to Addr_1 section.
13.4	07/13/2023	Updated content of section "Interlock 1 & 2".
13.5	11/02/2023	Updated as per OmniOn template

**OmniOn Power Inc.**

601 Shiloh Rd.  
Plano, TX USA

[omnionpower.com](http://omnionpower.com)

We reserve the right to make technical changes or modify the contents of this document without prior notice. OmniOn Power does not accept any responsibility for errors or lack of information in this document and makes no warranty with respect to and assumes no liability as a result of any use of information in this document.

We reserve all rights in this document and in the subject matter and illustrations contained therein. Any reproduction, disclosure to third parties or utilization of its contents – in whole or in parts – is forbidden without prior written consent of OmniOn Power. This document does not convey license to any patent or any intellectual property right. Copyright© 2023 OmniOn Power Inc. All rights reserved.