

DATASHEET

CLP0212 Open Frame Power Supply

90-264V_{ac} Input; 12V_{dc} Output; 200W Output Power



Description

In a small 2 x 4 inch footprint, the 12V_{dc} single-output CLP0212 open frame power supply delivers 80 PLUS Gold energy efficiency. With its small size, the CLP series is specifically designed to handle power challenges associated with tight space and low airflow. Offering a leading 18W/in³ power density in a 1U high, fan-less form factor, the CLP series addresses a broad range of applications in new products from

communications, computing and data storage original equipment manufacturers (OEMs). It delivers greater than 90 percent typical power efficiency and full load output at +50 °C (122 °F) with higher temperature operation possible at derated output. The CLP series utilizes a unique design approach at this power level, leveraging zero voltage switching techniques in conjunction with quasi-resonant power factor correction (PFC) circuits. Protection features include overcurrent (OCP), overvoltage (OVP), and overtemperature (OTP).

Applications

- Telecommunications equipment
- Embedded Computing
- Storage Systems
- Industrial equipment

Features

- Compact size 50.8 mm x 101.6 mm x 36.1 mm (2 in x 4 in x 1.4 in) with density of 18 W/in³
- Universal AC Input Range (90 – 264VAC)
- Output voltage of 12V (adjustable ±5%)
- Maximum output current of 16.7A@ 12Vout (200W)
- Standby output of 5V @ 0.25A
- High efficiency with 80 PLUS® Gold Certification
- Full load capability at 50°C and 1m/s (200 LFM) airflow with derating at higher temperatures or lower airflows
- Remote ON/OFF
- Output overcurrent protection (non-latching)
- Overtemperature protection
- Output overvoltage protection
- Up to 12ms of holdup time
- Parallellable with current sharing
- Active power factor corrected input
- Conducted EMI - meets CISPR32 (EN55032) and FCC Class A requirements
- Compliant to RoHS II EU “Directive 2011/65/EU” and amended Directive (EU) 2015/863.
- Compliant to REACH Directive (EC) No 1907/2006
- UL and cUL approved to UL/CSA62368-1, TUV (EN62368- 1), CE Mark (for LVD) and CB Report available
- ISO** 9001 and ISO 14001 certified manufacturing facilities

Footnotes

*UL is a registered trademark of Underwriters Laboratories, Inc.

†CSA is a registered trademark of Canadian Standards Association.

*VDE is a registered trademark of Verband Deutscher Elektrotechniker e.V.

** ISO is a registered trademark of the International Organization of Standard

Technical Specifications

Absolute Maximum Ratings

Stresses in excess of the absolute maximum ratings can cause permanent damage to the device. These are absolute stress ratings only, functional operation of the device is not implied at these or any other conditions in excess of those given in the operations sections of the data sheet. Exposure to absolute maximum ratings for extended periods can adversely affect the device reliability.

Parameter	Device	Min	Max	Unit
Input Voltage - Continuous For up to 10 seconds max.	All	90	264	V _{ac}
	All	90	275	V _{ac}
Input Voltage – Continuous – CATV Powering trapezoidal waveform (Note: Output power is limited to 100W)	All	75	130	V _{RMS}
Operating Ambient Temperature (see Thermal Considerations section)	All	-25	70	°C
	CLP0212FPEX5Z01C	-40‡	85*	°C
	CLP0212FPEX5Z03C	-40‡	85*	°C
(in sealed enclosure applications with thermally conductive pad to enclosure, P _{O,max} = 110W)	CLP0212FPEX5Z03C	-40	55‡	°C
Storage Temperature	All	-40	85	°C
Humidity (non-condensing)	All	5	95	%
Altitude	All		5000	m

‡ Startup at -40°C is limited to 80% of maximum load (160W) for all versions.

* Unit is capable of operation up to 85°C ambient for brief periods of time provided humidity is kept below 40%. Sustained operation at 85°C when input voltage is above 230VAC and output power loading is at or near the maximum rated value can degrade reliability of the product.

† Ambient temperature outside the sealed enclosure containing the power supply.

Electrical Specifications

Parameter	Device	Min	Typ	Max	Unit
Operating Input Voltage	All	90	115/230	264	V _{ac}
Input Source Frequency	All	47	50/60	63	Hz
Input Current (V _{IN} = 90V _{ac})	All			4	A _{RMS}
Input Power Factor	All		0.95		
Inrush Transient Current (V _{IN} = 264V _{ac} , T _{amb} = 25°C)	All			100	A Peak
Leakage Current to earth ground (V _{IN} = 264V _{ac})	All			2	mA
Output Voltage Setpoint	All		12		V _{dc}
Output Voltage Tolerance (due to set point, temperature variations, load and line regulation)	All	-2		2	%
Output Voltage Adjustment Range	All	11.4		12.6	V _{dc}
Output Remote Sense Range	All			250	mV _{dc}
Output Load Regulation	All			1.5	%V _{out}
Output Line Regulation	All			0.5	%V _{out}
Output Ripple and Noise – measured with 0.1µF ceramic capacitor in parallel with 10µF electrolytic capacitor, at 25°C ¹ Peak-to-peak (20MHz Bandwidth)	All			180	mV _{p-p}

¹ Output ripple is 300mV p-p maximum at -40°C To reduce further, additional external capacitance needed.

Technical Specifications (continued)

Electrical Specifications (continued)

Parameter	Device	Min	Typ	Max	Unit
Dynamic Load Response – 50% to 100% load transient, 0.1A/ μ s slew rate	All			5%	%
Output voltage deviation	All			500	μ s
Settling Time					
Output Current	All	0		16.7	A _{dc}
Output Current Limit Inception	All		115		% I _{o,max}
Maximum Output Capacitance	All			5000	μ F
Standby Output Voltage	CLP0212FPEX5Z 01C		5		V _{dc}
Standby Output Current	CLP0212FPEX5Z 01C			0.25	A _{dc}
Efficiency : V _{IN} = 230V _{ac} , 20% load	All		86.8		%
50% load	All		91.1		%
100% load	All		89.5		%
V _{IN} = 115V _{ac} , 20% load	All		89.2		%
50% load	All		90.3		%
100% load	All		87.1		%
Holdup Time – V _{IN} = 115V _{ac} , 100% load ²	All		10		ms
V _{IN} = 230V _{ac} , 100% load	All		10		ms

² Holdup time is reduced at cold temperatures

Isolation Specifications

Parameter	Device	Min	Max	Unit
Isolation Voltage – Input to output	All		3000	V _{ac}
Input to safety ground	All		1500	V _{ac}
Outputs to safety ground	All		50	V _{ac}

General Specifications

Parameter	Device	Symbol	Typ	Unit
Calculated Reliability based on Telcordia SR-332 Issue 2: Method 1 Case 3 (V _{IN} =230V _{ac} , I _o = 16.7A, T _A = 40°C, airflow 200LFM, 90% confidence)	All	FIT MTBF	1,011.9 988,276	10 ⁹ /Hours Hours
Weight	All		185 6.5	g (oz.)

Technical Specifications (continued)

Feature Specifications

Parameter	Device	Min	Typ	Max	Unit
On/Off Signal Interface – signal referenced to GND					
Logic Low (Power Supply ON)					
Input Low Current	All			7	mA
Input Low Voltage	All			1	V
Logic High (Power Supply OFF)					
Input High Current	All			600	μA
Input Voltage	All			5.5	V
Delay from ON/OFF being enabled to start of output	All			50	ms
Output Voltage Rise Time (from 10 to 90% of final value)	All		5		ms
Delay from Input being applied to standby output being in	All		12		ms
Delay from Input being applied to all outputs being in	All		30		ms
Output Overvoltage Protection (for main output currents)	All	13.8		18	V _{dc}
Input Undervoltage lockout ³					
Turn-on Threshold (100% load)	All		86		V _{ac}
Turn-off Threshold (100% load)	All		82		V _{ac}
DC OK – open collector, High when output available					
Sink Current	All			4	mA
Maximum Collector Voltage	All			12	V

³The Undervoltage lockout threshold vary with output load current level – decreasing as the load goes down

Environmental Specifications

Parameter	Device	Specification/Test
Conducted Emissions	All	CISPR32 (EN55032) Class A with 3dB margin
Radiated Emissions	All	CISPR32 (EN55032) to comply with system enclosure
ESD	All	IEC61000-4-2, Level 3
Radiated Immunity	All	IEC61000-4-3, Level 2 *
Electrical Fast Transient Common Mode	All	IEC61000-4-4, Level 3
Surge Immunity	All	IEC61000-4-5, Level 3
Conducted RF Immunity	All	IEC61000-4-6, Level 3
Voltage Dips	All	EN61000 4.11, Level 3, Class B, C
Input Voltage Dips	All	Output stays within regulation for either ½ cycle interruption or 25% dip from nominal line for 1 second
Input Harmonics	All	IEC61000-3-2
Shock and Vibration	All	IPC-9592B

* Radiated immunity is met when the power supply is tested in a suitable enclosure.

Technical Specifications (continued)

Characteristic Curves

The following figures provide typical characteristics for CLP0212 power supply.

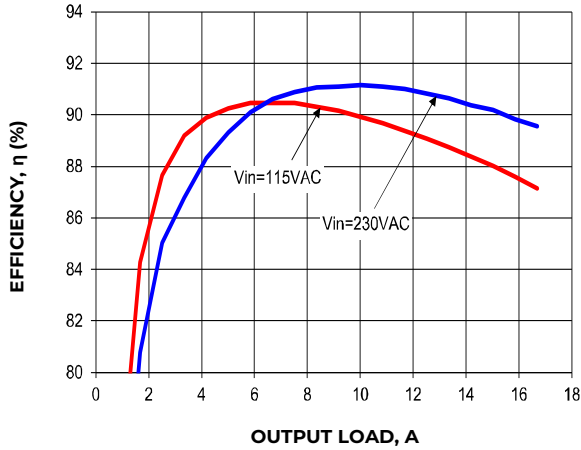

Figure 1. Power Supply Efficiency versus Output Current.

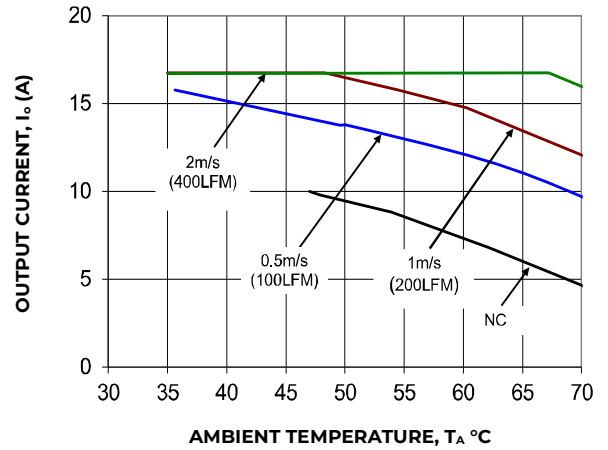

Figure 2. Derating Output Current versus Ambient Temperature and Airflow. Data shown for 115V_{AC} in, at 230V_{AC} in derating is the same or better. For derating at other input voltages, consult the OmniOn Technical representative.

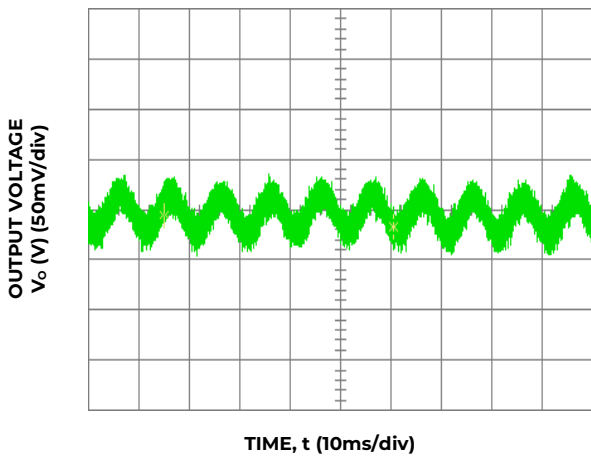

Figure 3. Typical output ripple and noise ($V_{IN} = 230V_{ac}$, 100% load).

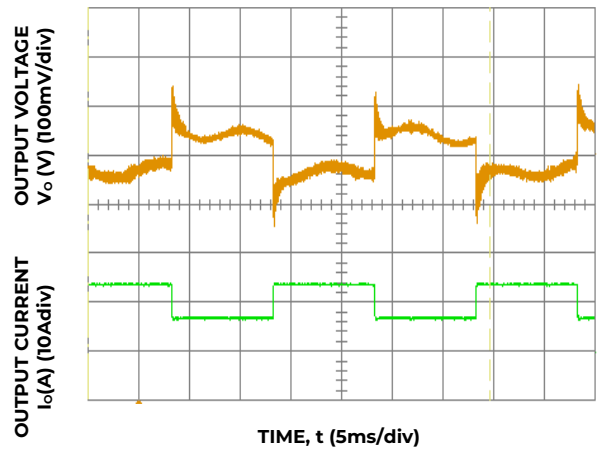

Figure 4. Transient Response to Dynamic Load Change from 50% to 100% at $V_{IN} = 230V_{ac}$

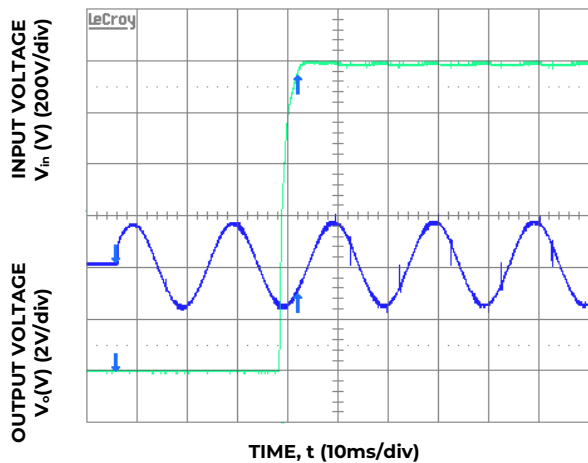

Figure 5. Typical Start-up ($V_{IN} = 115V_{ac}$).

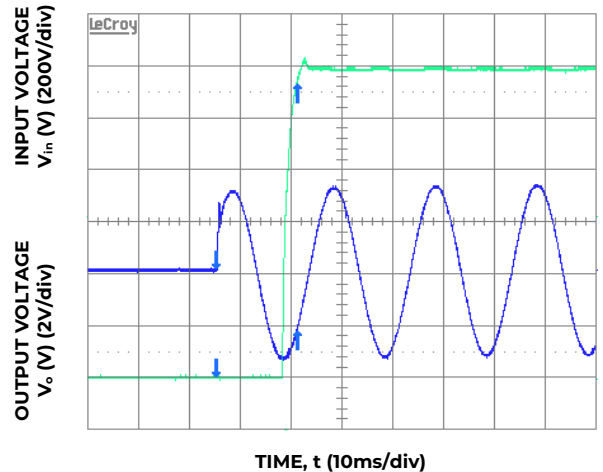

Figure 6. Typical Start-up ($V_{IN} = 230V_{ac}$)

Technical Specifications (continued)

Characteristic Curves (Continued)

The following figures provide typical characteristics for CLP0212 power supply.

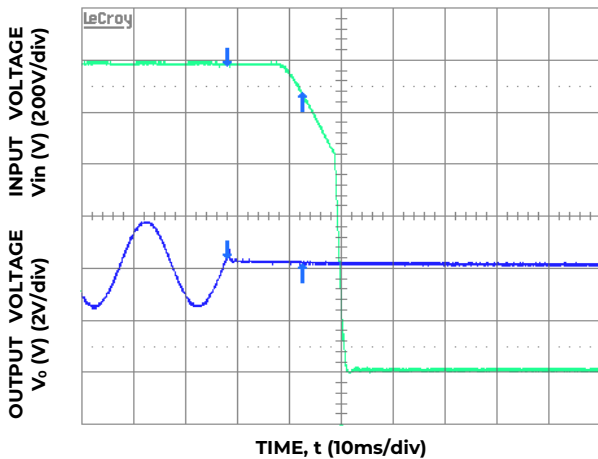

Figure 7. Typical Hold-up waveforms ($V_{IN} = 115V$, 100% load).

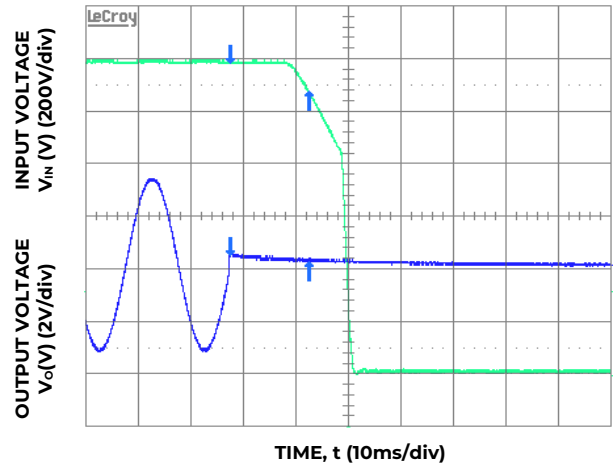

Figure 8. Typical Hold-up waveforms ($V_{IN} = 230V$, 100% load).

Safety Considerations

The CLP0212 power supply is intended for inclusion in other equipment and the installer must ensure that it is in compliance with all the requirements of the end application. This product is only for inclusion by professional installers within other equipment and must not be operated as a stand-alone product. The power supply meets Class 1, IEC62368-1, EN62368-1, with the applicable national deviations which approved by TUV and UL (Recognized Component) C-UL (Canadian Approval by UL).

Feature Descriptions

Standby Power Supply

A standby output in the CLP0212 power supply of 5V, comes on when AC input in the operating range is applied. In the Z02A and Z03A versions of the power supply, the standby output is not accessible

Remote On/Off

All versions of the CLP0212 power supply except the Z02A and Z03A versions feature a TTL-compatible On/Off control input. The power supply turns ON when the On/Off input goes low, and turns OFF when the input goes high. Note that if the On/Off pin is left unconnected, the power supply main output remains off.

Figure 9 shows the circuit configuration for using the On/Off pin. Either a suitable semiconductor device such as a BJT or FET or a mechanical switch can be

used to turn the power supply On and Off. The switch must be capable of handling the On/Off pin current which may be up to 6mA when closed. The switch On voltage drop must also be sufficiently small so that the photo diode inside the power supply is turned ON when the external switch is ON.

Note that the standby output voltage is 5V. If no On/Off control is desired, the On/Off pin can be externally connected to the COM pin and the power supply will automatically turn ON when AC input is within range.

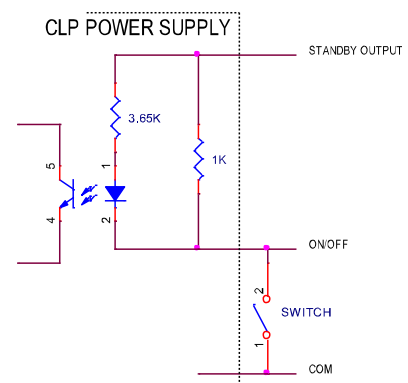

Fig. 9. Schematic showing ON/OFF circuitry.

Technical Specifications (continued)

Output Voltage Adjustment

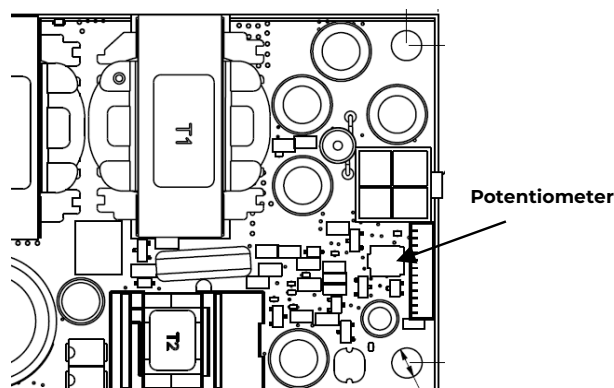

Fig. 10. Diagram showing location of the potentiometer used to adjust the power supply output voltage.

The output voltage can be adjusted between 11.4V and 12.6V using a potentiometer on the power supply. See Fig. 10 for a diagram showing location of the potentiometer.

Remote Sense

The power supply has both positive and negative remote sense connections that can be connected to the positive and negative rails of the main output near the load. Care should be taken in routing the sense lines to ensure that noise is not picked up or that additional filtering elements that affect the stability of the power supply are not used. The power supply will operate without the remote sense connections being made, however if remote sense near the load is not used it is recommended that the remote sense lines be connected directly to the main output terminals.

Overcurrent Protection

To provide protection in a fault condition (output overload), the power supply is equipped with internal current-limiting circuitry and can endure current limiting continuously. At the point of current-limit inception, the unit enters hiccup mode. The power supply operates normally once the output current is brought back into its specified range.

Overvoltage Protection

Overvoltage protection is a feature of the CLP0212 power supply that protects both the load and the power supply from an output overvoltage condition. When an overvoltage occurs, the power supply shuts down and latches off until the overvoltage condition is removed. It is necessary to recycle the input to restart the power supply when this protection is activated.

Overtemperature Protection

The CLP0212 also features overtemperature protection in order to provide additional protection in a fault condition. The power supply is equipped with a thermal shutdown circuit which detects excessive internal temperatures and shuts the unit down. Once the power supply goes into overtemperature shutdown, it will cool before attempting to restart. The overtemperature protection circuit will typically activate in when the unit is operated at 200W output with an ambient temperature of 60°C and 1m/s (200LFM) airflow.

Input Undervoltage Lockout

At input voltages below the input undervoltage lockout limit, power supply operation is disabled. The power supply will begin to operate at an input voltage above the undervoltage lockout turn-on threshold. Note that the undervoltage lockout limits are load dependent and the power supply turns ON and can operate at much lower input voltage levels when at light or no load.

DC OK

The CLP0212 provides a DC OK signal that indicates when the output has come up and is in regulation. This is an open-collector type signal that goes high when the output is available and within regulation.

Power Good LED

A green LED (located next to HDR3) illuminates when the main output voltage is above 10V.

Paralleling/Load Share

This power supply can be paralleled to provide larger load currents than can be delivered from a single power supply. Up to four power supplies may be paralleled. Paralleling is accomplished by connecting the Current Share signals of multiple power supplies together. At load current levels above 20%, the output currents of multiple power supplies will be within $\pm 5\%$ of the full load value.

If remote sense is used when paralleling is employed, the remote sense connection points should be common to both power supplies.

For applications where redundancy among paralleled power supplies is desired, ORing diodes or other active ORing circuitry needs to be connected in series with each output.

Thermal Considerations

Technical Specifications (continued)

The power supply can be operated in a variety of thermal environments; however sufficient cooling should be provided to ensure reliable operation.

Considerations include ambient temperature, airflow, power supply dissipation and the need for increased reliability. A reduction in the operating temperature of the power supply will result in increased reliability. The thermal data presented here is based on measurements taken in a wind tunnel.

Heat Transfer via Convection

Increased airflow through the power supply enhances the heat transfer via convection. Figure 11 shows the preferred airflow direction. Contact your OmniOn technical representative for derating information in other airflow directions.

Note: Under Natural Convection cooling conditions, the maximum load is restricted to 100W as OTP will be triggered at higher loads.

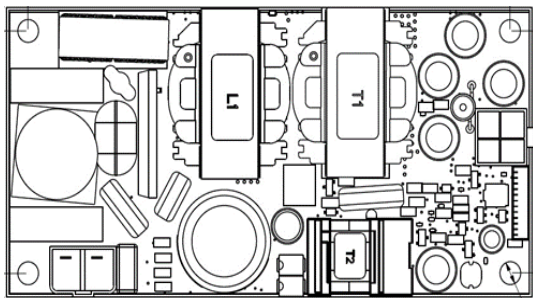

Fig. 11. Preferred airflow direction for cooling.

The CLP0212 power supply can also be operated in a sealed enclosure provided proper means for removing heat from the power supply are used. Figure 12 shows an arrangement where a thermally conductive pad is used to transfer heat from the bottom of the power supply into the enclosure. Under such conditions, the power supply is capable of reduced power operation as shown in Table 1. Note that the Ambient Temperature shown in Table 1 is that outside the sealed enclosure, the CLP0212 may see higher ambient temperatures.

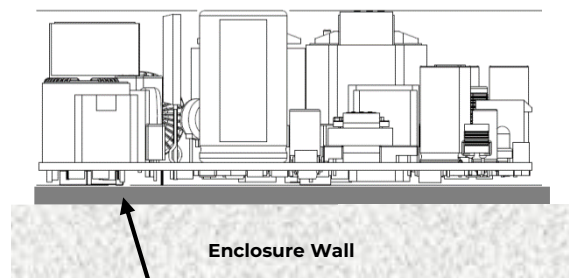

Fig. 12. Thermally Conductive Pad arrangement of the CLP0212 for sealed enclosure applications

Table 1. Output Power Capability when the CLP0212 is operated in

Ambient Temperature (°C)	Max. Output Power (W)
25	170
40	150
55	110
55 (CATV Powering Input Voltage Waveform)	100

a sealed enclosure with thermal pad for conduction cooling.

Operation in a Sealed Enclosure

Technical Specifications (continued)

Mechanical Outline (CLP0212FPEX5Z01C)

Dimensions are in millimeters.

Tolerances: x.x mm ± 0.5mm [unless otherwise indicated]

x.xx mm ± 0.25mm

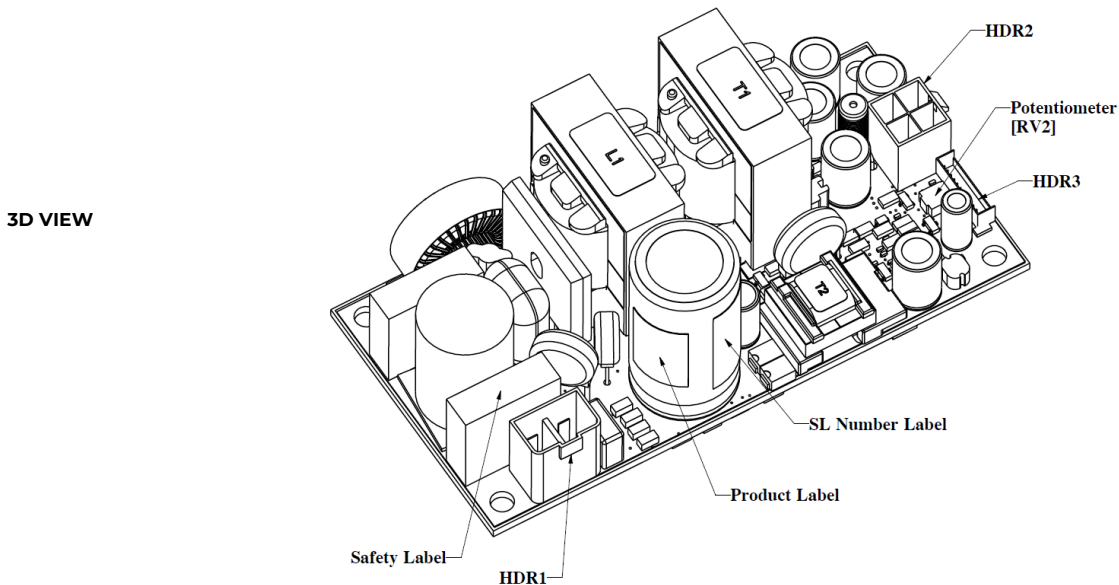
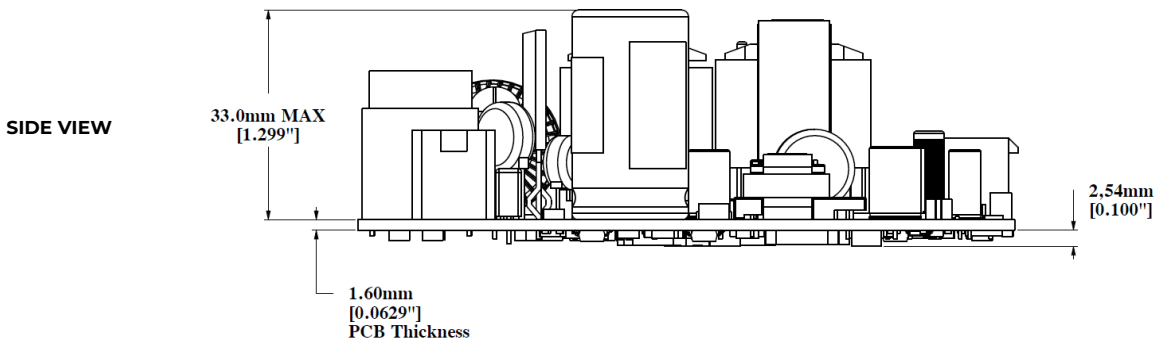
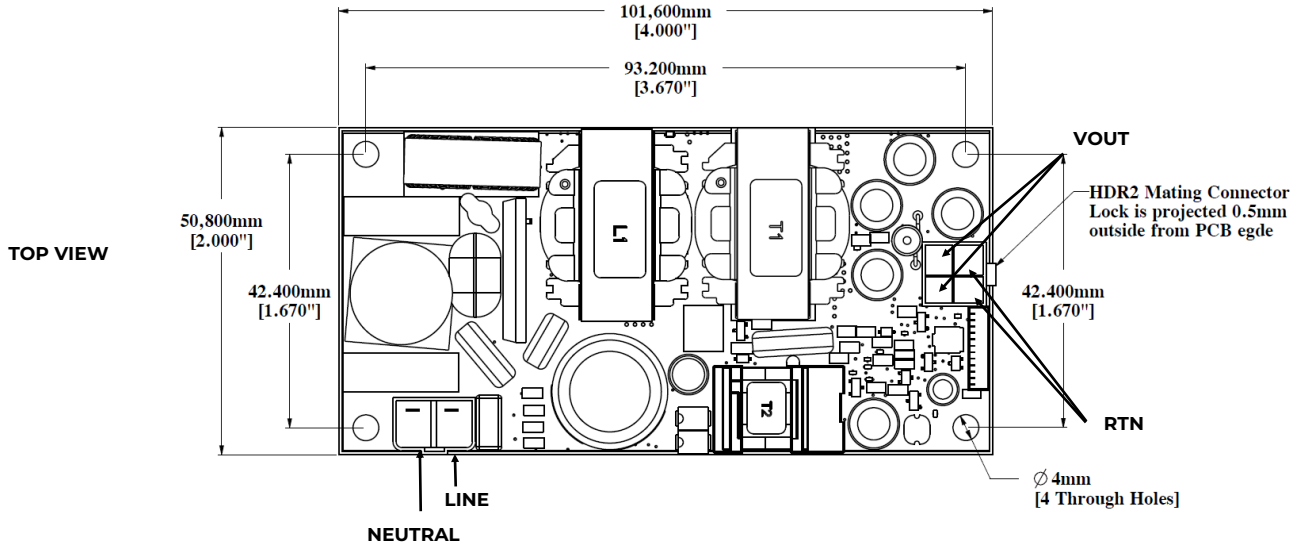

Technical Specifications (continued)

Mechanical Outline (CLP0212FPEX5Z03C)

Dimensions are in millimeters.

Tolerances: x.x mm ± 0.5mm [unless otherwise indicated]

x.xx mm ± 0.25mm

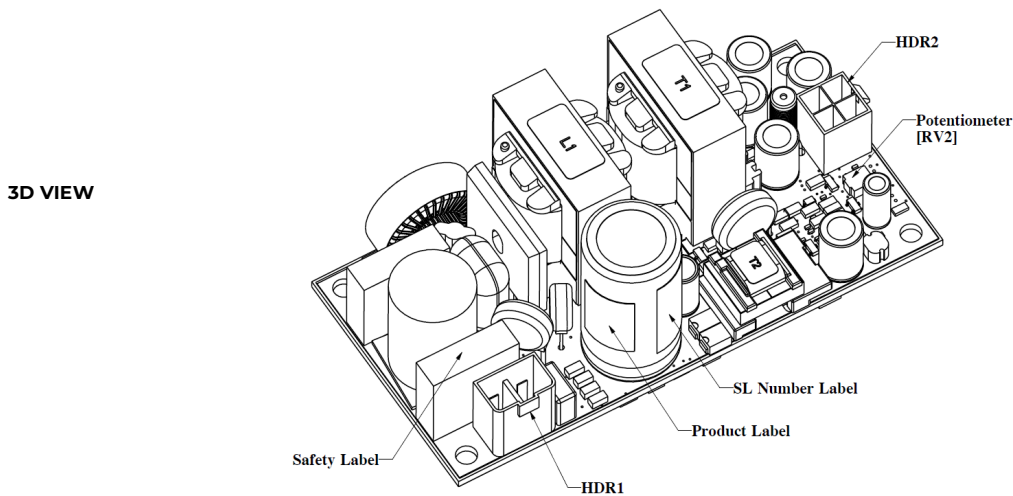
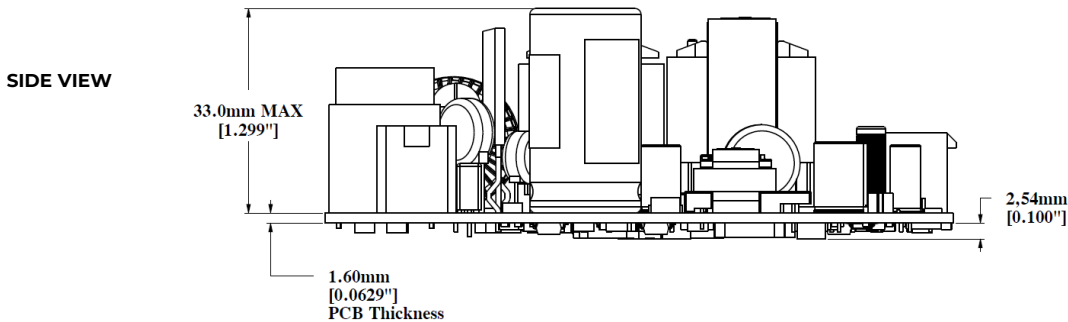
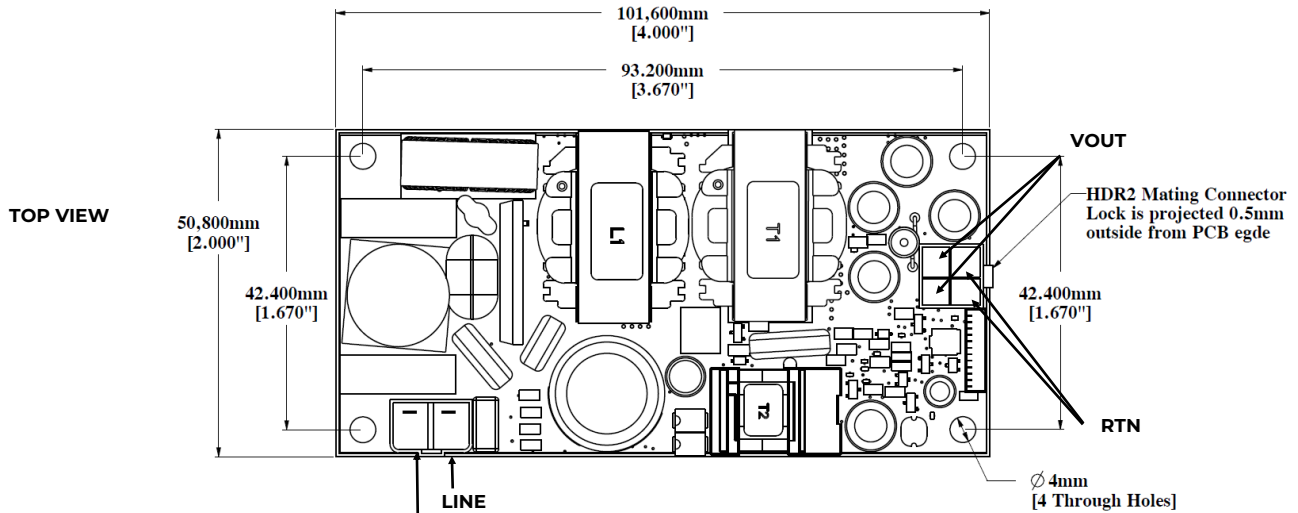

Technical Specifications (continued)

Connector Information

Connector	Connector on Power Supply	Mating Connector
AC Input Connector (HDR1)	5-1376382-1 from Tyco or equivalent	1376388-1 from Tyco or equivalent
DC Output Connector (HDR2)	39-28-1043 from Molex or equivalent	39-01-2040 from Molex or equivalent
Signal Connector** (HDR3)	53047-0810 from Molex or equivalent	51021-0800 from Molex or equivalent

Pinout Information

AC Input Connector (HDR1)		DC Output Connector (HDR2)		Signal Connector** (HDR3)	
Pin 1	Line	Pin 1	V _o	Pin 1	Current Share
Pin 2	Neutral	Pin 2	V _o	Pin 2	+S (Remote Sense +)
		Pin 3	RTN	Pin 3	-S (Remote Sense -)
		Pin 4	RTN	Pin 4	Remote On/Off
				Pin 5	DC-OK (Output OK)
				Pin 6	COM (Output Return)
				Pin 7	COM (Output Return)
				Pin 8	Standby Output

** Note: Signal Connector HD3 is not present in Z03C version.

Ordering Information

Please contact your OmniOn Sales Representative for pricing, availability and optional features.

Device Code	Input Voltage Range	Output Voltage	Output Current	On/Off Control	Standby Supply	Temperature Range	Ordering Code
CLP0212FPEX5Z01C	90 – 264V _{ac}	12.0V _{dc}	16.7A	Negative Logic	5V@0.25A	-40 to 70°C	150038518
CLP0212FPEX5Z03C	90 – 264V _{ac}	12.0V _{dc}	16.7A	Absent	Not accessible	-40 to 70°C	150038520

Table 2. Device Codes.

Contact Us

For more information, call us at

+1-877-546-3243 (US)

+1-972-244-9288 (Int'l)

Change History (excludes grammar & clarifications)

Revision	Date	Description of the change
8.3	12/01/2021	Updated as per template
8.4	06/23/2023	Correction in electrical specifications table on
8.5	11/02/2023	Updated as per OmniOn template

OmniOn Power Inc.

601 Shiloh Rd.
Plano, TX USA

omnionpower.com

We reserve the right to make technical changes or modify the contents of this document without prior notice. OmniOn Power does not accept any responsibility for errors or lack of information in this document and makes no warranty with respect to and assumes no liability as a result of any use of information in this document.

We reserve all rights in this document and in the subject matter and illustrations contained therein. Any reproduction, disclosure to third parties or utilization of its contents – in whole or in parts – is forbidden without prior written consent of OmniOn Power. This document does not convey license to any patent or any intellectual property right. Copyright© 2023 OmniOn Power Inc. All rights reserved.