

DATASHEET

FLP0412FPx Open Frame Power Supply

90 - 265Vac input; 2-4 outputs; 450W Output Power



Description

In a small 3 x 7 inch footprint, the 450W 2-4 output FLP0412x open frame power supply delivers greater than 90 percent typical power efficiency and full load output at 42°C and 1m/s airflow. Protection features include output overcurrent (OCP), overvoltage (OVP), and overtemperature (OTP). There is power trading between the outputs. Whatever power is going to be taken from V2, V3, and V4, should be deducted from the gross power available from V1. This unit also offers PMBus control and monitoring of V3 and V4. Use of this feature is optional.

Applications

- Industrial equipment
- Telecommunications equipment

Features

- Compact size 76.2 mm x 178 mm x 36.8 mm (3 in x 7 in x 1.45 in) with density of 15 W/in³
- Universal AC Input Range (90 – 265VAC)
- Output voltages of +12V (adjustable ±5%), +24V (adjustable 16-34V), +5V (adjustable 1-5.5V), +3.3V (adjustable 1-5.5V)
- Standby output of 5V @ 1A
- Maximum output current of 37.5A12V, 2A24V, 12A5V, 12A3.3V (450W total, see description below)
- High efficiency (>91% at Full Load, 230VAC in)
- Full load capability at 42°C and 1m/s airflow with derating at higher temperatures or lower airflows
- Capable of 320W out in sealed enclosure applications with enclosure ambient at 55°C
- Output overcurrent protection (non-latching)
- Overtemperature protection
- Output overvoltage protection
- Minimum of 11ms of holdup time at 450W out
- Parallelable with output current sharing on main 12V output-option, please request details
- Active power factor corrected input
- Conducted EMI - meets CISPR32 (EN55032) and FCC Class B requirements
- Compliant to RoHS Directive 2011/65/EU and amended Directive (EU) 2015/863.
- UL and cUL approved to UL/CSA62368-1, TUV (EN62368-1), CE Mark (for LVD) and CB Report available
- Compliant to REACH Directive (EC) No 1907/2006
- ISO** 9001 and ISO 14001 certified manufacturing facilities

See footnotes on page 4

Technical Specifications

Absolute Maximum Ratings

Stresses in excess of the absolute maximum ratings can cause permanent damage to the device. These are absolute stress ratings only, functional operation of the device is not implied at these or any other conditions in excess of those given in the operations sections of the data sheet. Exposure to absolute maximum ratings for extended periods can adversely affect the device reliability.

Parameter	Device	Min	Max	Unit
Input Voltage - Continuous	All	90	265	V _{ac}
For up to 10 seconds	All	90	275	V _{ac}
Operating Ambient Temperature (see Thermal Considerations section)	All	-40	85	°C
Storage Temperature	All	-40	85	°C
Humidity (non-condensing)	All	5	95	%
Altitude	All		5000	m
Isolation Voltage – Input to output	All		3000	V _{ac}
Input to safety ground	All		1500	V _{ac}
Outputs to safety ground	All		50	V _{ac}

Electrical Specifications

Parameter	Device	Min	Typ	Max	Unit
Operating Input Voltage	All	90	115/230	265	V _{ac}
Input Source Frequency	All	47	50/60	63	Hz
Input Current (V _{IN} = 90V _{ac})	All			6	A _{RMS}
Input Power Factor (230V _{ac} , Full Load)	All	0.95			
Inrush Transient Current (V _{IN} = 265V _{ac} , T _{amp} = 25°C)	All			60	A _{Peak}
Leakage Current to earth ground (V _{IN} = 265V _{ac})	All			3.5	mA
V1 Output Voltage Setpoint	All		12		V _{dc}
V1 Output Voltage Tolerance (due to set point, temperature variations, load and line regulation)	All	-2		2	%
V1 Output Voltage Adjustment Range	All	11.4		12.6	V _{dc}
V1 Output Remote Sense Range	All			250	mV _{dc}
V1 Output Load Regulation	All			1	%V _{out}
V1 Output Line Regulation	All			0.5	%V _{out}
V1 Output Ripple and Noise - measured with 0.1µF ceramic capacitor in parallel with 470µF electrolytic capacitor Peak-to-peak (20MHz Bandwidth)	All			400	mV _{p-p}
V1 Dynamic Load Response - 50% to 100% transient, 1A/µs slew rate	All			5%	%
Output voltage deviation	All			500	µs
Settling Time	All			500	µs
V1 Output Current gross - see page 1	All	0		37.5	A _{dc}
V1 Output Current Limit Inception	All	105		145	% I _{O,max}
V1 Maximum Output Capacitance	All			10000	µF
Standby Output Voltage	All		5		V _{dc}
Standby Output Current	All			1	A _{dc}
Efficiency: V _{IN} = 230V _{ac} , 20% load	All		84.5		%
50% load	All		91.3		%
100% load	All		91.9		%
V _{IN} = 115V _{ac} , 20% load	All		83.5		%
50% load	All		89.9		%
100% load	All		90		%
Holdup Time ¹ – V _{IN} = 115V _{ac} , 450W load	All	11			ms
V _{IN} = 230V _{ac} , 450W load	All	11			ms

See footnotes on page 4

Technical Specifications (continued)

General Specifications

Parameter	Device	Symbol	Typ.	Unit
Calculated Reliability based on Telcordia SR-332 Issue 3: Method 1 Case 3 (VIN=230Vac, I _o = 30A, TA = 40°C, airflow 200LFM, 90% confidence)	All	MTBF	>650,000	Hours
Weight	All		420 15	g oz.

Feature Specifications

Parameter	Device	Min	Typ	Max	Unit
On/Off Signal Interface – signal referenced to GND					
Logic Low (Power Supply ON)					
Input Low Current	All			7	mA
Input Low Voltage	All			1	V
Logic High (Power Supply OFF)					
Input High Current	All			600	µA
Input Voltage	All			5.5	V
Delay from ON/OFF being enabled to start of output	All			50	ms
Output Voltage Rise Time (from 10 to 90% of final)	All		20		ms
Delay from Input being applied to all outputs being	All			1	s
V _I Output Overvoltage Protection	All	13.8		16	Vdc
Input Undervoltage lockout²					
Turn-on Threshold (100% load)	All	85	87.6	90	Vac
Turn-off Threshold (100% load)	All	82	83.9	88	Vac
V_I DC OK – open collector, High when output					
Sink Current	All			4	mA
Maximum Collector Voltage	All			12	V

Environmental Specifications

Parameter	Device	Specification/Test
Conducted Emissions	All	CISPR32 (EN55032) Class B with 3dB margin
Radiated Emissions	All	CISPR32 (EN55032) to comply with system
ESD	All	IEC61000-4-2, Level 4, performance criterion A
Radiated Susceptibility	All	IEC61000-4-3, Level 3
Electrical Fast Transient Common Mode	All	IEC61000-4-4, Level 3
Surge Immunity	All	IEC61000-4-5, Level 4
Conducted RF Immunity	All	IEC61000-4-6, Level 3
Input Voltage Dips	All	Output stays within regulation for either ½ cycle interruption or 25% dip from nominal line for 1 second
Input Harmonics	All	IEC61000-3-2
Shock and Vibration	All	IPC-9592B

See footnotes on page 4

Technical Specifications (continued)

Safety Specifications

Parameter	Device	Specification
Dielectric Withstand Voltage (between input and	All	Minimum of 4,250Vdc for 1 minute
Insulation Resistance (between input and outputs)	All	Minimum of 5 MΩ
Safety Standards	All	Class 1, IEC62360, EN62360, with the following deviations: Nemko, UL 62360 (Recognized Component), cUL (Canadian Approval by UL)

FOOTNOTES

* UL is a registered trademark of Underwriters Laboratories, Inc.

† CSA is a registered trademark of Canadian Standards Association.

‡ VDE is a trademark of Verband Deutscher Elektrotechniker e.V.

** ISO is a registered trademark of the International Organization of Standards

¹ Holdup time may be lower at cold temperatures

² Undervoltage lockout threshold may vary with output load current level – decreasing as load goes lower

Technical Specifications (continued)

V2 +24V, 0-2A, provided by built-in ABXS002A3X41-SRZ

The output voltage can be adjusted by potentiometer RV2 over the range 16V to 34V.

V2 is provided by an ABXS002A3X41-SRZ which has around it the components required to ensure it meets the rest of this specification. V2+, V2powergood, and V2return are brought to the auxiliary output connector (HDR4).

V2 Turn-on happens when V1 reaches 91% of its nominal value. Turn-off happens when V1 goes below 86% or above 112% of its nominal value. V2 features the OTP, OCP, and OVP as provided by the converter.

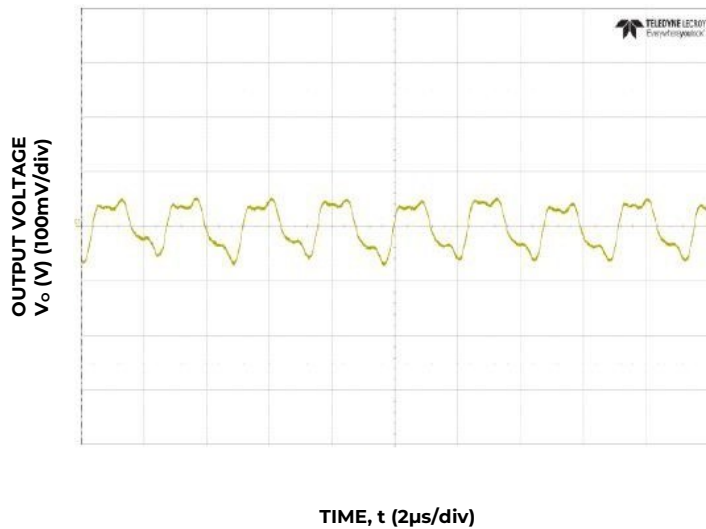

Figure 9. Typical output ripple and noise
($C_o = 66\mu\text{F}$ ceramic, $V_{IN} = 12\text{V}$, $I_o = I_{o,max}$)

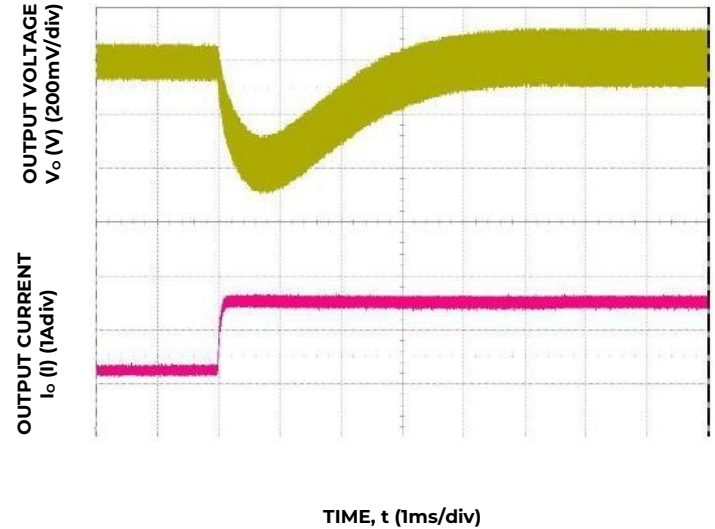

Figure 10. Transient Response to Dynamic Load Change from 50% to 100% at 12V_{IN}, C_{out}=3x10uF+220uF, CTune=3300pF, RTune=30.1kΩ

Overcurrent Protection

To provide protection in a fault (output overload) condition, the unit is equipped with internal current-limiting circuitry and can endure current limiting continuously. At the point of current-limit inception, the unit enters hiccup mode. The unit operates normally once the output current is brought back into its specified range.

Power Good

The module provides a Power Good (PGOOD) signal that is implemented with an open-drain output to indicate that the output voltage is within the regulation limits of the power module. The PGOOD signal will be de-asserted to a low state if any condition such as overtemperature, overcurrent or loss of regulation occurs that would result in the output voltage going outside the specified thresholds. The PGOOD terminal can be connected through a pullup resistor (suggested value 10kΩ) to a source of 5VDC or lower.

Technical Specifications (continued)

Schematic for V2

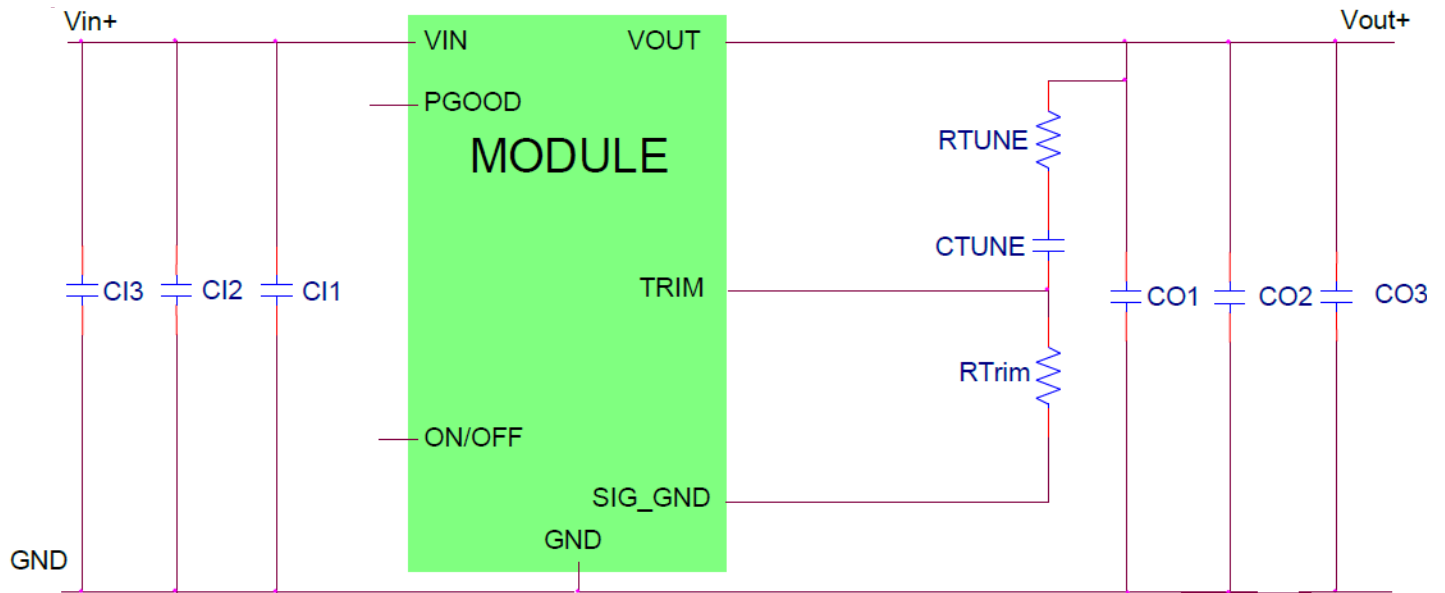

C11	1 x 0.047 μ F/50V, 0603 ceramic capacitor
C12	4 x 10 μ F/50V, 1210 ceramic capacitor
C13	1 x 220 μ F/25V, bulk electrolytic
CO1	1 x 0.01 μ F/100V, 0805 ceramic capacitor
CO2	9 x 4.7 μ F/100V, 1210 ceramic capacitor
CO3	1 x 220 μ F/100V, bulk electrolytic
CTune	220pF ceramic capacitor (can be 1206, 0805 or 0603 size)
RTune	40.2 k Ω SMT resistor (can be 1206, 0805 or 0603 size)

The output voltage is able to be adjusted by potentiometer RV2 over the range 16V to 34V, and this replaces the Rtrim shown above.

Technical Specifications (continued)

V3 and V4 +5V (default) and +3.3V (default), 0-12A, provided by two built-in PDT012

The output voltages are adjusted by potentiometers RV3 and RV4 over the range 1V to 5.5V.

V3 and V4 are provided by a PDT012 which have around them the components required to ensure they meet the rest of this specification. V3/4+, V3/4sense+, V3/4powergood, and V3/4return are brought to the auxiliary output connector (HDR4).

Clock, Data, SMB Alert#, and 0V are brought to the PMBus connector (HDR5).

All of the digital features are the same as the PDT012 data sheet. For detailed digital interface specifications and feature descriptions, refer to PDT012 datasheet.

V3 and V4 Turn-on happens when V1 reaches 91% of its nominal value. Turn-off happens when V1 goes below 86% or above 112% of its nominal value. V3 and V4 feature the OTP, OCP, and OVP as provided by the converters, and as modified by the customer using PMBus.

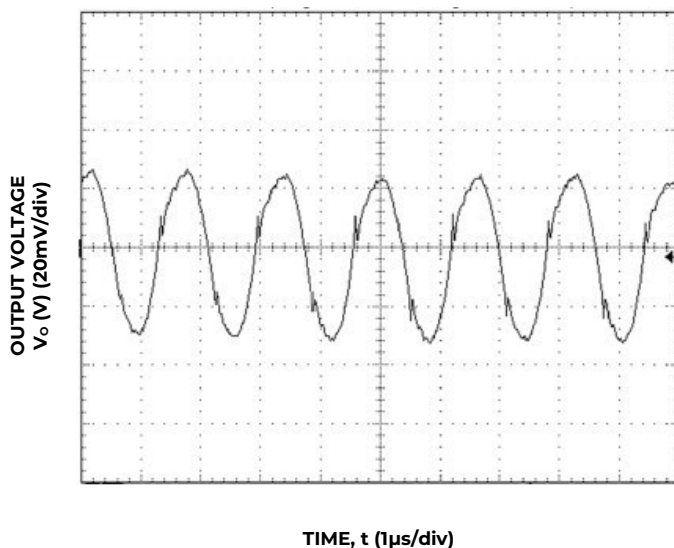

Figure 33. Typical output ripple and noise
($C_o = 22\mu\text{F}$ ceramic, $V_{IN} = 12\text{V}$, $I_o = I_{o,max}$)

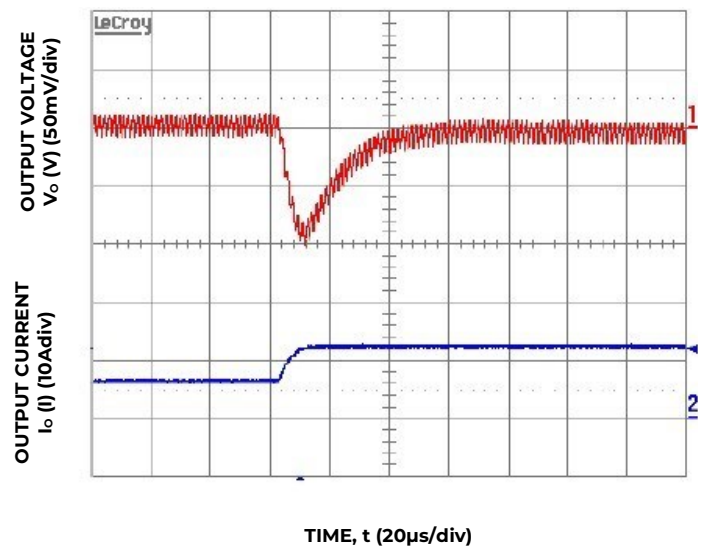

Figure 34. Transient Response to Dynamic Load Change
from 50% to 100% at 12V_{IN} , $C_{out} = 5 \times 47\mu\text{F}$, $C_{Tune} = 1500\text{pF}$, $R_{Tune} = 330\text{ohms}$

Overcurrent Protection

To provide protection in a fault (output overload) condition, the unit is equipped with internal current-limiting circuitry and can endure current limiting continuously. At the point of current-limit inception, the unit enters hiccup mode. The unit operates normally once the output current is brought back into its specified range.

Power Good

The module provides a Power Good (PGOOD) signal that is implemented with an open-drain output to indicate that the output voltage is within the regulation limits of the power module. The PGOOD signal will be de-asserted to a low state if any condition such as overtemperature, overcurrent or loss of regulation occurs that would result in the output voltage going $\pm 10\%$ outside the setpoint value. The PGOOD terminal can be connected through a pullup resistor (suggested value $100\text{k}\Omega$) to a source of 5VDC or lower.

Technical Specifications (continued)

Schematic for V3 and V4 +5V (default) and +3.3V (default), 0-12A

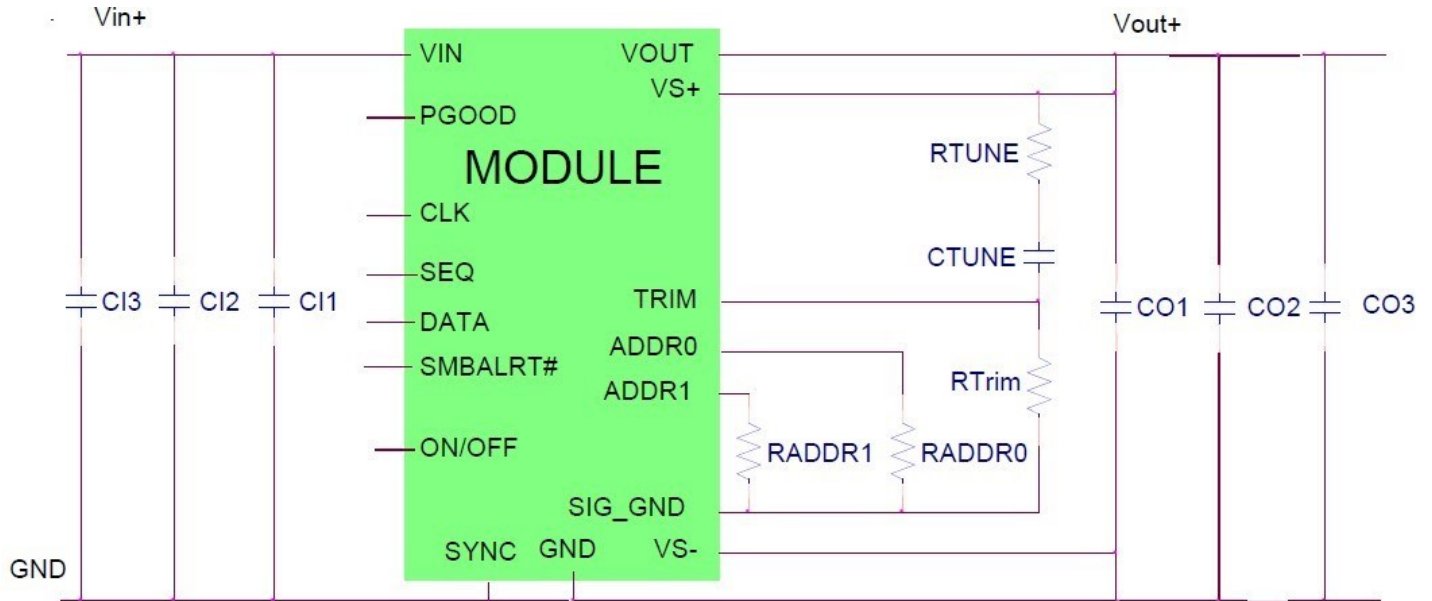

C11	Decoupling cap - 1 x 0.047 μ F/16V, ceramic capacitor (e.g. Murata LLL185R71C473MA01)
C12	2 x 22 μ F/16V, ceramic capacitor (e.g. Murata GRM32ER61C226KE20)
C13	470 μ F/16V, bulk electrolytic
CO1	Decoupling cap - 1 x 0.047 μ F/16V, ceramic capacitor (e.g. Murata LLL185R71C473MA01)
CO2	2 x 47 μ F/6.3V, ceramic capacitor (e.g. Murata GRM31CR60J476ME19)
CO3	1 x 330 μ F/6.3V, Polymer (e.g. Sanyo Poscap)
CTune	3300pF ceramic capacitor (can be 1206, 0805 or 0603 size)
RTune	270 ohms SMT resistor (can be 1206, 0805 or 0603 size)

The output voltages are adjusted by potentiometers RV3 and RV4 over the range 1V to 5.5V. These potentiometers replace the fixed Rtrim shown above.

Technical Specifications (continued)

PGOOD (Power Good)						
Signal Interface Open Drain, $V_{\text{supply}} \leq 5\text{VDC}$						
Overvoltage threshold for PGOOD ON	All			108		$\%V_{o, \text{set}}$
Overvoltage threshold for PGOOD OFF	All			110		$\%V_{o, \text{set}}$
Undervoltage threshold for PGOOD ON	All			92		$\%V_{o, \text{set}}$
Undervoltage threshold for PGOOD OFF	All			90		$\%V_{o, \text{set}}$
Pulldown resistance of PGOOD pin	All				50	Ω
Sink current capacity into PGOOD pin	All				5	mA

Technical Specifications (continued)

Safety Considerations

The FLP0412FPx power supply is intended for inclusion in other equipment and the installer must ensure that it is in compliance with all the requirements of the end application. This product is only for inclusion by professional installers within other equipment and must not be operated as a stand-alone product. The power supply meets Class 1, IEC62368-1, EN62368-1, with the applicable national deviations which approved by TUV and UL (Recognized Component) C-UL (Canadian Approval by UL).

Feature Descriptions

Standby Power Supply

A standby output of 5V in the FLP0412FPx power supply, comes on when AC input in the operating range is applied.

Remote On/Off

The FLP0412FPx power supply features a TTL-compatible On/Off control input. The power supply turns ON when the On/Off input goes low, and turns OFF when the input goes high. Note that if the On/Off pin is left unconnected, the power supply main output shall remain off.

V1 Output Voltage Adjustment

The V1 output voltage is adjusted between 11.4V and 12.6V using a potentiometer (RV1) on the power supply.

V1 Remote Sense

The power supply has both positive and negative remote sense connections that can be connected to the positive and negative rails of the main output near the load. The power supply operates without the remote sense connections being made.

V1 Overcurrent Protection

To provide protection in a fault condition (output overload), the power supply is equipped with internal current-limiting circuitry and can endure current limiting continuously. At the point of current-limit inception, the unit enters hiccup mode. The power supply operates normally once the output current is brought back into its specified range.

V1 Overvoltage Protection

Overvoltage protection is a feature of the FLP0412FPx power supply that protects both the load and the power supply from an output overvoltage condition. When an overvoltage occurs, the power supply shuts down and latches off until the overvoltage condition is removed. It is necessary to recycle the input to restart the power supply when this protection is activated.

Overtemperature Protection

The FLP0412FPx also features overtemperature protection in order to provide additional protection in a fault condition. The power supply is equipped with a thermal shutdown circuit which detects excessive internal temperatures and shuts the unit down. Once the power supply goes into overtemperature shutdown, it will cool before attempting to restart. The overtemperature protection circuit will typically trigger when the unit is operated at 450W output with an ambient temperature of 53°C and 1m/s (200LFM) airflow.

Input Undervoltage Lockout

At input voltages below the input undervoltage lockout limit, power supply operation is disabled. The power supply begins to operate at an input voltage above the undervoltage lockout turn-on threshold

V1 DC OK

The FLP0412FPx provides a DC OK signal that indicates when the output has come up and is in regulation. This is an open-collector type signal that goes high when the output is available and within regulation.

V1 Power Good LED

A green LED on board the power supply illuminates when the main output voltage is above 10V.

Paralleling V1 with Active Output Current Sharing

This power supply has optional parallel operation with active V1 output current sharing. Paralleling is accomplished by connecting the Current Share signals of the power supplies together. At load current levels above 20%, the output currents of multiple power supplies will be within $\pm 5\%$ of the full load value. This feature is an option.

Technical Specifications (continued)

Thermal Considerations

The power supply can be operated in a variety of thermal environments, however sufficient cooling should be provided to ensure reliable operation.

Considerations include ambient temperature, airflow, power supply dissipation and the need for increased reliability. A reduction in the operating temperature of the power supply will result in increased reliability. The thermal data presented here is based on measurements taken during testing in a wind tunnel.

Heat Transfer via Convection

Increased airflow through the power supply enhances the heat transfer via convection. Below figure shows the preferred airflow direction. Contact your OmniOn technical representative for derating information in other airflow directions.

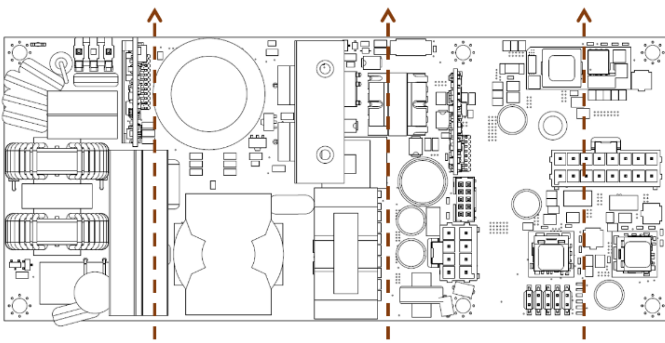

Thermal Derating Characteristic Curve

Following curve data shown for model FLP0412FPMXXZ01A with 115V_{ac} input. At 230V_{ac} input derating is the same or better. For derating at other input voltages and other models, consult the OmniOn Technical representative.

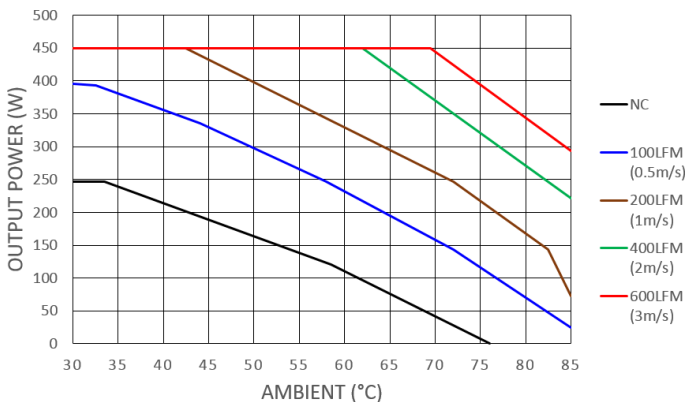

Operation in a Sealed Enclosure

The FLP0412 power supply can also be operated in a sealed enclosure or in an environment where cooling is primarily via conduction. Bottom figure shows an arrangement where thermally conductive pads are used to transfer heat from the top and bottom of the power supply into the enclosure. Under such conditions, the power supply is capable of reduced power operation as shown in Table 1.

Cold Wall Temperature (°C)	Max. Output Power (W)
25	420
55	320

Table 1. Output Power Capability when the FLP0412 is cooled primarily via conduction.

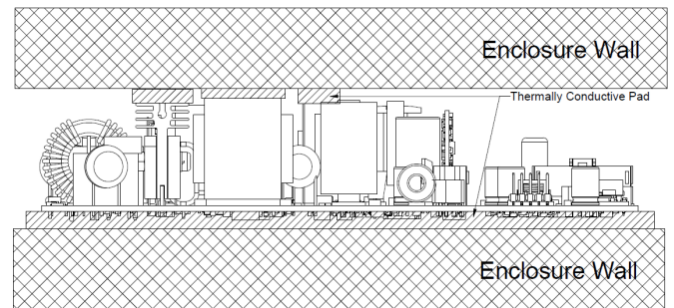
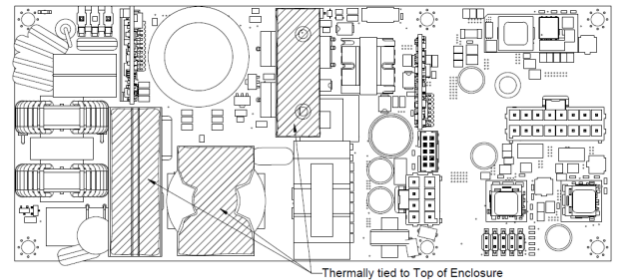

Example arrangement of the FLP0412 for sealed enclosure applications.

Technical Specifications (continued)

Mechanical Outline

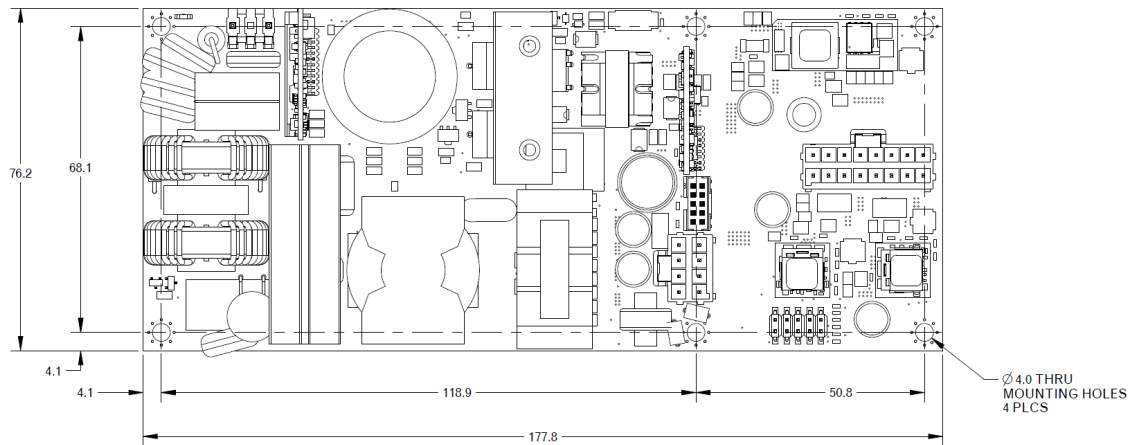

TOP VIEW

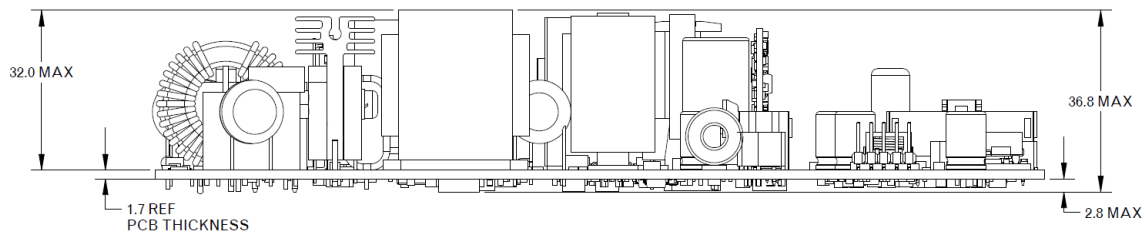

SIDE VIEW

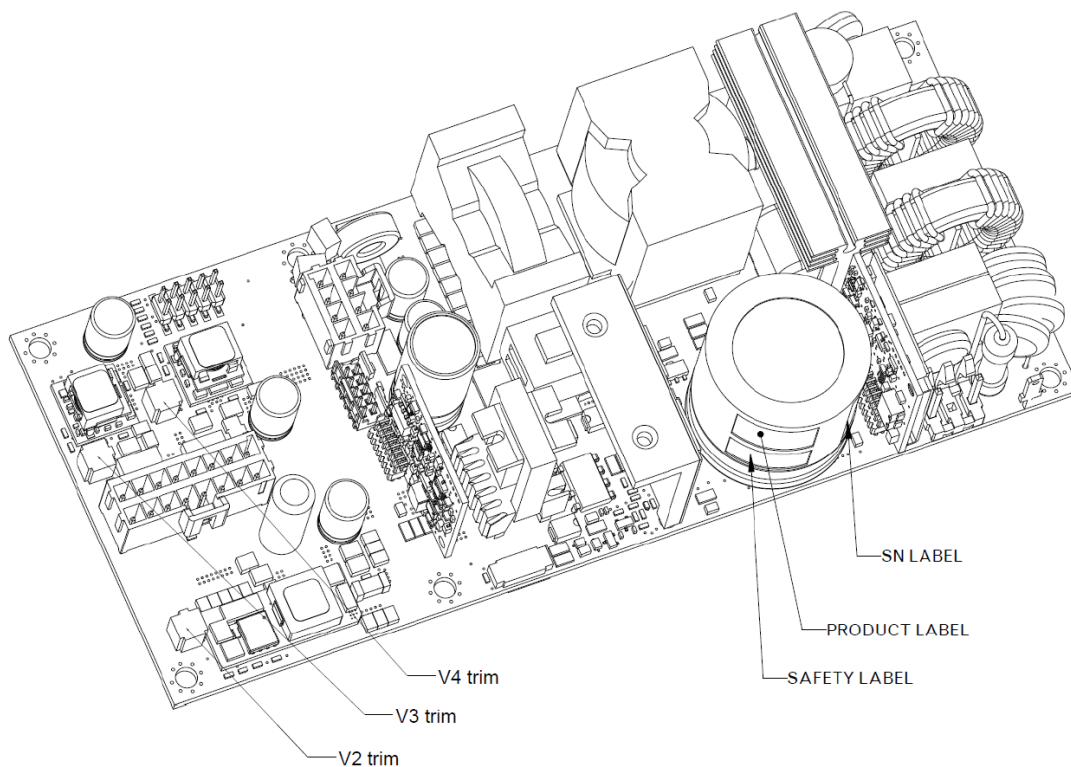

3D VIEW

Technical Specifications (continued)

Connector Information

Connector	Connector on Power Supply	Mating Connector
AC Input Connector (HDR1)	Molex 41671-3437 or equivalent	Molex 09-50-3031 or equivalent
V1 DC Output Connector (HDR2)	Molex 172298-1208 or equivalent	Molex 172258-1008 or equivalent
Auxiliary signal Connector (HDR3)	FCI 98414-G04-10ULF or equivalent	FCI 90311-010LF or equivalent
Auxiliary power connector (HDR4)	Molex 172298-1216 or equivalent	Molex 172258-1016 or equivalent
PMBus connector (HDR5)	Molex 015-91-6102 or equivalent	OmniOn CC408650477, Molex 10-way, or equivalent

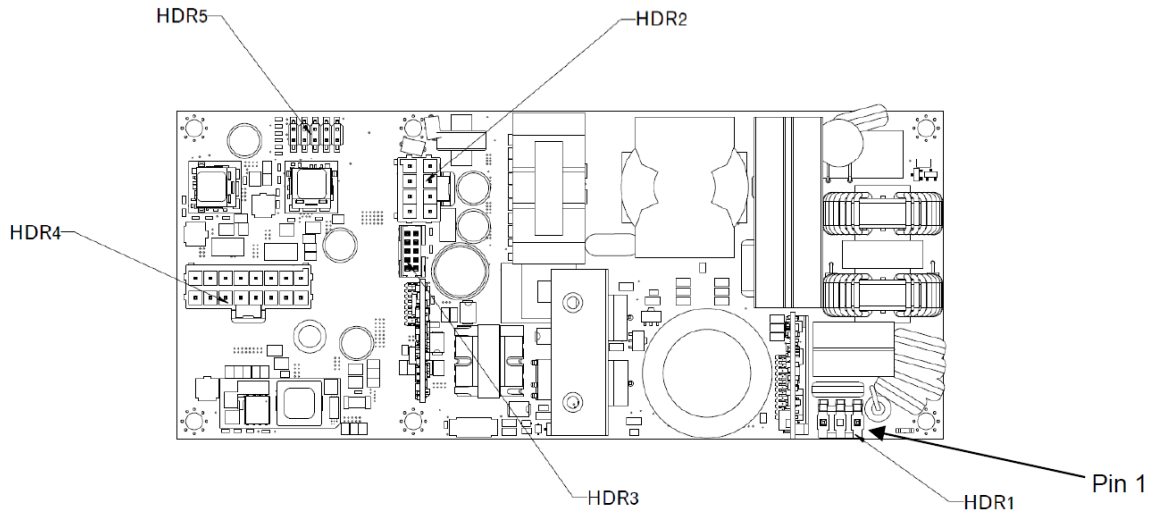

Pinout Information

AC Input Connector (HDR1)		DC Output Connector (HDR2)		Auxiliary Connector (HDR3)	
Pin 1 (Right side)	Line	Pins 1, 2, 3, 4	V1+	A1, A2 = 5V standby	B1 = V1 Ishare
Pin 2	removed	Pins 5, 6, 7, 8	V1 return = 0V	A3 – not connected	B2, B3 = 5V return 0V
Pin 3	Neutral			A4 = V1 sense+	B4 = V1 OK
				A5 = V1 sense-	B5 = on/off

DC Output Connector (HDR4)		PMBus Connector (HDR5)		Connector	
V2+	1	Not connected	1, 2, 3, 4, 5, 7		
V2 return = 0V	2	Ground	6		
V2 power good	3	SMB Alert#	8		
V3+	4, 5	Clock	9		
V3 return = 0V	6, 7	Data	10		
V3 sense	8				
V3 power good	9				
V4+	10, 11				
V4 return = 0V	12, 13				
V4 sense	14				
V4 power good	15				

Technical Specifications (continued)

Ordering Information

Please contact your OmniOn Sales Representative for pricing, availability and optional features.

Device Code	Input Voltage Range	Output Voltages	Output Currents	V2-V4 Setting	Standby Supply	Temperature Range	Ordering Code
FLP0412FPMXXZ01A	90 – 265Vac	12/24/5/3.3V	37.5/2/12/12A	Trim Pots	5V @ 1A	-40 to 85°C	FLP0412FPMXXZ01A
FLP0412FP4XXZ01A	90 – 265Vac	12/24/5/3.3V	37.5/2/12/12A	Fixed Resistors	5V @ 1A	-40 to 85°C	FLP0412FP4XXZ01A
FLP0412FP3XXZ01A	90 – 265Vac	12/24/5V	37.5/2/12A	Fixed Resistors	5V @ 1A	-40 to 85°C	FLP0412FP3XXZ01A
FLP0412FP2XXZ01A	90 – 265Vac	12/24V	37.5/2A	Fixed Resistors	5V @ 1A	-40 to 85°C	FLP0412FP2XXZ01A

Table 1. Device Codes

Change History (excludes grammar & clarifications)

Revision	Date	Description of the change
4.3	09/24/2021	Updated as per template and upgraded RoHS standard
4.4	08/02/2023	Updated value of "VI Output Ripple and Noise" in electrical specifications
4.5	10/18/2023	Updated as per OmniOn template

OmniOn Power Inc.

601 Shiloh Rd.
Plano, TX USA

omnionpower.com

We reserve the right to make technical changes or modify the contents of this document without prior notice. OmniOn Power does not accept any responsibility for errors or lack of information in this document and makes no warranty with respect to and assumes no liability as a result of any use of information in this document.

We reserve all rights in this document and in the subject matter and illustrations contained therein. Any reproduction, disclosure to third parties or utilization of its contents – in whole or in parts – is forbidden without prior written consent of OmniOn Power. This document does not convey license to any patent or any intellectual property right. Copyright© 2023 OmniOn Power Inc. All rights reserved.