

## DATASHEET

# IND108W Hornet: Non-Isolated DC-DC Voltage Regulator Modules Voltage Regulator Modules

12Vdc input; 3Vdc to 8Vdc output; 80W Max Power

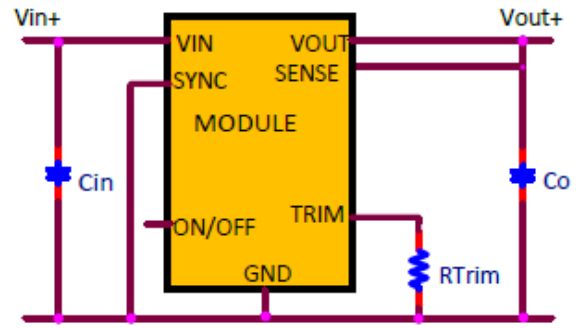

## Applications

- Industrial Equipment
- Control Boards
- Test Equipment

## Electrical Features

- 12V Input voltage with  $\pm 20\%$  Tolerance
- Output voltage programmable from 3Vdc to 8Vdc via external resistor
- Remote On/Off for optional external control
- Fixed switching frequency
- Sync Capability
- Output overcurrent protection (non-latching)

## Process and Safety

- Qualified for 1000h High Temperature Operating Bias, 1000h 85RH/85°C Temperature, Humidity and Bias, 700 cycle -40 to 125°C thermal cycling.
- ANSI/UL<sup>†</sup> 62368-1 and CAN/CSA<sup>†</sup> C22.2 No. 62368-1 Recognized, DIN VDE<sup>‡</sup> 0868-1/A11:2017 (EN62368-1:2014/A11:2017)
- ISO<sup>™</sup> 9001 and ISO 14001 certified manufacturing facilities
- Compliant to RoHS Directive 2011/65/EU and amended Directive (EU) 2015/863
- Compliant to REACH Directive (EC) No 1907/2006
- Compatible in a Pb-free or SnPb reflow environment.
- Suitable for aqueous clean.
- Suitable for conformal coating with dip and vapor deposition. Conformal coating can provide the protection to meet Salt Fog Test per IEC 60068-2-52 (Severity 3) and Mixed Gas Flow test per Telcordia GR-3108 Outdoor Levels.
- 3 year warranty

## Mechanical Features

- Small size: 33 mm x 13.46 mm x 10 mm (1.3 in x 0.53 in x 0.39 in)
- Operating range: -40°C to 105°C ambient
- Operating shock to 40G per Mil Std. 810G, Method 516.4 Procedure I
- Operating vibration per Mil Std. 810G, Method 514.5 Procedure I

Device Code	Input Voltage	Output Voltage	Output Current (Max.)	On/Off Logic	Ordering Code
IND108W	9.6 – 14.4Vdc	3.0 – 8.0Vdc	12A(@3Vout)	Negative	1600102907A

## Thermal Performance

Full rated output with natural convection up to 82°C at 3.3Vout and up to 86°C at 5Vout. Thermal curves for both voltages below.

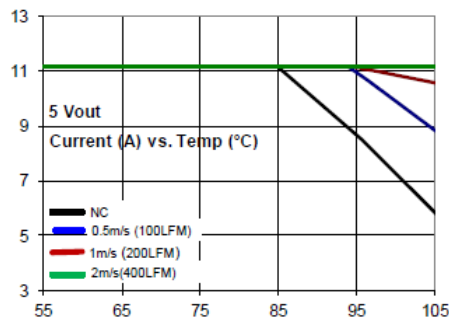
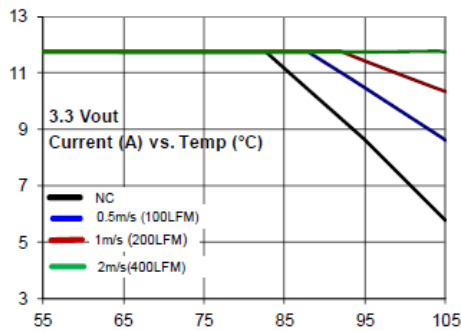

## Electrical Specifications

Parameter	Device	Symbol	Min	Typ	Max	Unit
Operating Input Voltage	All	$V_{IN}$	9.6	12	14.4	Vdc
External Capacitance, Ceramic $ESR \geq 1 \text{ m}\Omega$	All	$C_{O,max}$		–	100*	$\mu\text{F}$
Efficiency $12V_{INDC}, T_A=25^\circ\text{C}, I_o$ as per Figure 2		$\eta$	91(3.3V <sub>o</sub> ), 93(5V <sub>o</sub> )			%
Switching Frequency	All	$f_{sw}$	–	308	–	kHz
Output Voltage (Over all line, load, and temperature conditions)	All	$V_{O,set}$	-2.5	–	+2.5	% $V_{O,set}$
On/Off Logic High (MODULE OFF) Input High	All	$V_{IH}$	1.8	–	36	Vdc
On/ Off Logic Low (MODULE ON) Input Low Voltage	All	$V_{IL}$	-0.2	–	0.3	Vdc
<b>Frequency Synchronization</b>						
Synchronization Frequency Range			$f_{SW}$		1.1 $f_{SW}$	kHz
Input high voltage			2			V
Input low voltage					0.8	V
Input Current, SYNC					10	nA
Minimum SYNC Pulse Width			50			ns

\*Additional External Capacitance possible using Tunable Loop

## Characteristic Curves

The following figures provide typical characteristics for the IND108W Hornet at 25°C.

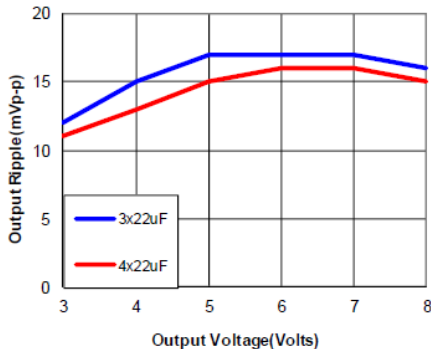

**Figure 1. Output Ripple Voltage for various output voltages and external caps @12Vin. Additional Decoupling cap of 0.01uF used on input and output side**

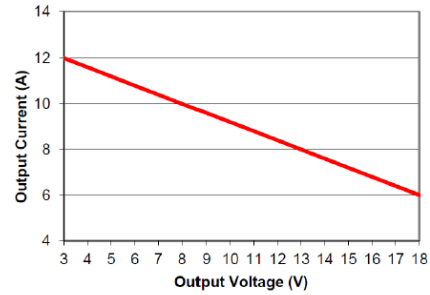

**Figure 2. Graph showing maximum output current capability at different output voltages.**

Use electrical profile in Figure 2 for determining baseline output current for a specific voltage. Then thermal curves.

## Trim

Rtrim for a desired output voltage, should be as per the following table. The formula in the last column helps determine Rtrim for other voltages.

Vo (V)	3.3	5.0	6	8	Rtrim = $\left[ \frac{70}{(Vo - 0.7)} \right]$ kW
Rtrim (kΩ)	26.92	16.27	13.2	9.59	

## Safety Considerations

For safety agency approval, the power module must be installed in compliance with the spacing and separation requirements of the end-use safety agency standards listed on the first page of this document. For the converter output to be considered meeting the requirements of safety extra-low voltage (SELV) or ESI, the input must meet SELV/ ESI requirements. The power module has extra-low voltage (ELV) outputs when all inputs are ELV. The input to these units is to be provided with a fast-acting fuse with a maximum rating of 8A in the positive input lead.

## Tunable Loop

The module is designed for 47uF capacitor on its output. For applications where more than 47uF capacitors would be used on the output, an additional Resistor (Rtune) and Capacitor (Ctune) would be required in the circuit schematic to compensate for the additional capacitance. The placement is between the Sense+ pin and Trim pin as per figure below:

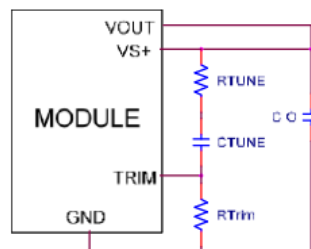

**Figure 3. Circuit diagram showing connection of R<sub>TUNE</sub> and C<sub>TUNE</sub> to tune the control loop of the module**

## Tunable Loop (continue)

The recommended values for  $R_{TUNE}$  and  $C_{TUNE}$  for different amounts of external capacitance are as per the table below:

Co	5 x 22 $\mu$ F	6 x 22 $\mu$ F	7 x 22 $\mu$ F	8x 22 $\mu$ F	10 x 22 $\mu$ F
$R_{TUNE}$	300 $\Omega$	300 $\Omega$	240 $\Omega$	240 $\Omega$	240 $\Omega$
$C_{TUNE}$	2700pF	3300pF	3900pF	4700pF	6800pF

## Synchronization (SYNC)

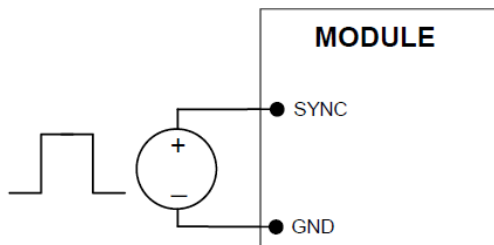

**Figure 4. External source connections to synchronize switching frequency of the module.**

The regulator switching frequency can be synchronized to a signal with an external frequency within a specified range. Synchronization can be done by using the external signal applied to the SYNC pin of the module as shown in Fig. 4, with the converter being synchronized by the rising edge of the external signal. The Electrical Specifications table specifies the requirements of the external SYNC signal. If the SYNC pin is not used, the module should free run at the default switching frequency. If synchronization is not being used, connect the SYNC pin to GND.

## Recommended Pad Layout

Dimensions are in millimeters and (inches).

Tolerances: x.x mm  $\pm$  0.5 mm (x.xx in.  $\pm$  0.02 in.) [unless otherwise indicated] x.xx mm  $\pm$  0.25 mm (x.xxx in  $\pm$  0.010 in.)

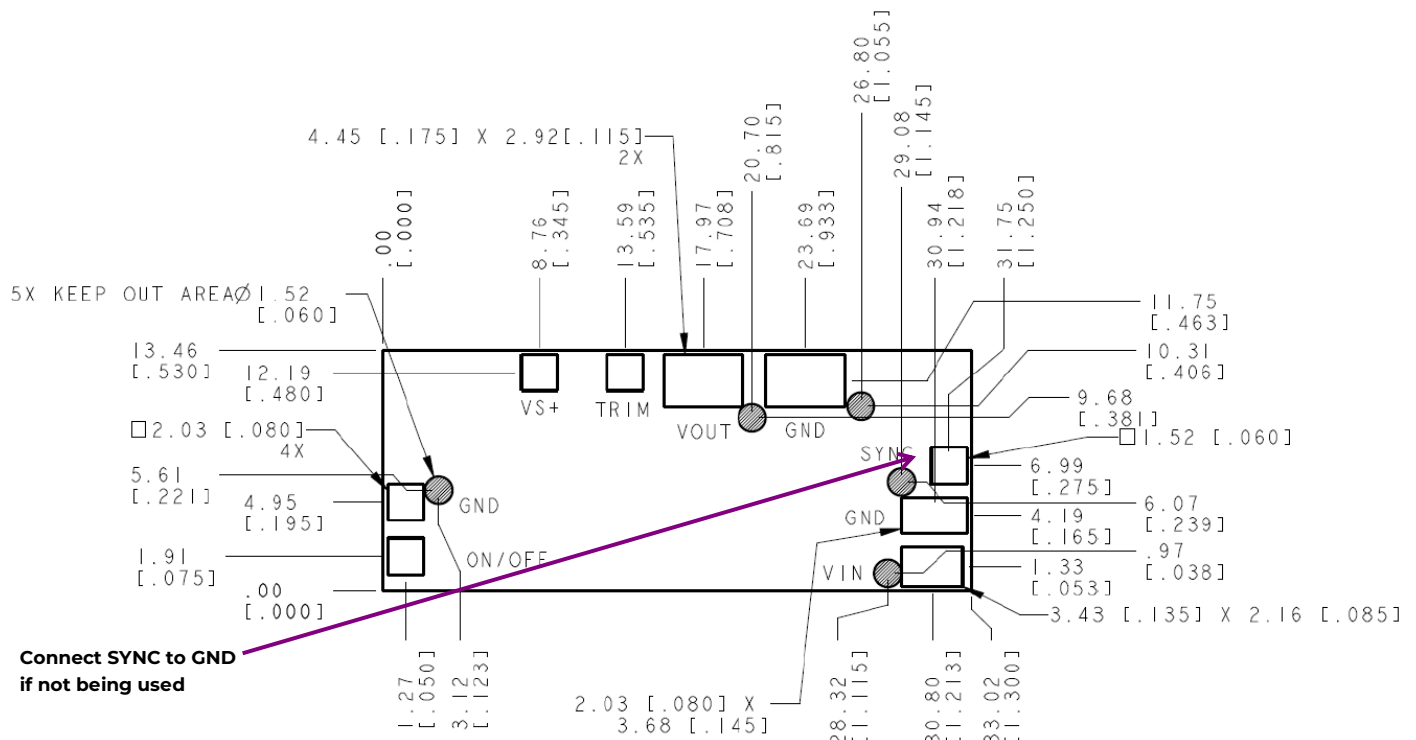

## Nozzle Recommendations

The minimum recommended inside nozzle diameter for reliable operation is 3mm. The maximum nozzle outer diameter, which will safely fit within the allowable component spacing, is 7 mm.

## Bottom Side / First Side Assembly

This module is not recommended for assembly on the bottom side of a customer board. If such an assembly is attempted, components may fall off the module during the second reflow process.

## Lead Free Soldering

The modules are lead-free (Pb-free) and RoHS compliant and fully compatible in a Pb-free soldering process. Failure to observe the instructions below may result in the failure of or cause damage to the modules and can adversely affect long-term reliability.

## MSL Rating

The modules have a MSL rating of 2a.

## Pb-free Reflow Profile

Power Systems will comply with J-STD-020 Rev. D (Moisture/Reflow Sensitivity Classification for Non hermetic Solid State Surface Mount Devices) for both Pb-free solder profiles and MSL classification procedures. The suggested Pb-free solder paste is Sn/Ag/Cu (SAC).

The following profile is the recommended linear reflow profile using Sn/Ag/Cu solder. Soldering outside of the recommended profile requires testing to verify results and performance.

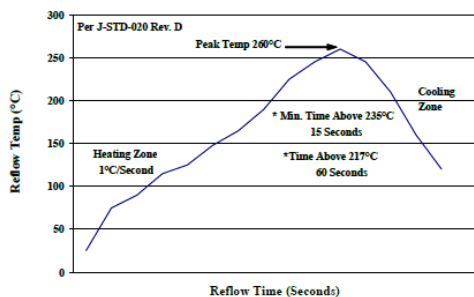

## Storage and Handling

J-STD-033 Rev. A (Handling, Packing, Shipping and Use of Moisture/Reflow Sensitive Surface Mount Devices) is recommended. Moisture barrier bags (MBB) with desiccant are required for MSL ratings of 2 or greater. These sealed packages should not be broken until time of use. Once the original package is broken, the floor life of the product at conditions of  $\leq 30^{\circ}\text{C}$  and 60% relative humidity varies according to the MSL rating (see J-STD-033A). The shelf life for dry packed SMT packages will be a minimum of 12 months from the bag seal date, when stored at the following conditions:  $< 40^{\circ}\text{C}$ ,  $< 90\%$  relative humidity.

## Post Solder Cleaning and Drying Considerations

Post solder cleaning is usually the final circuit-board assembly process prior to electrical board testing. The result of inadequate cleaning and drying can affect both the reliability of a power module and the testability of the finished circuit-board assembly

## Contact Us

For more information, call us at  
 1-877-546-3243 (US)  
 1-972-244-9288 (Int'l)

OmniOn Critical Power reserves the right to make changes to the product(s) or information contained herein without notice, and no liability is assumed as a result of their use or application. No rights under any patent accompany the sale of any such product(s) or information.

## Change History (excludes grammar & clarifications)

Revision	Date	Description of the change
5.3	09/29/2021	Updated as per template
5.4	06/21/2023	Tunable Loop tables values corrected on page - 4
5.5	10/19/2023	Updated as per OmniOn template

**OmniOn Power Inc.**

601 Shiloh Rd.  
Plano, TX USA

[omnionpower.com](http://omnionpower.com)

We reserve the right to make technical changes or modify the contents of this document without prior notice. OmniOn Power does not accept any responsibility for errors or lack of information in this document and makes no warranty with respect to and assumes no liability as a result of any use of information in this document.

We reserve all rights in this document and in the subject matter and illustrations contained therein. Any reproduction, disclosure to third parties or utilization of its contents – in whole or in parts – is forbidden without prior written consent of OmniOn Power. This document does not convey license to any patent or any intellectual property right. Copyright© 2023 OmniOn Power Inc. All rights reserved.