

DATASHEET

QHHD019A0B Hammerhead* Series; DC-DC Converter Power Modules

18V_{dc} –75V_{dc} input; 12V_{dc} output; 19A Output Current

RoHS Compliant



Description

The QHHD019A0B [HAMMERHEAD*] Series, quarter-brick, low-height power modules are isolated dc-dc converters which provide a single, precisely regulated output voltage over an ultra-wide input voltage range of 18-75V_{dc}. The QHHD019A0B provides 12V_{dc} nominal output voltage rated for 19A_{dc}

output current. The module incorporates OmniOn's vast heritage for reliability and quality, while also using the latest in technology, and component and process standardization to achieve highly competitive cost. The open frame module construction, enable designers to develop cost and space efficient solutions. The module achieves typical full load efficiency greater than 93% at V_{IN}=24V_{dc} and V_{IN}=48V_{dc}. Standard features include remote On/Off, remote sense, output voltage adjustment, overvoltage, overcurrent and over temperature protection. An optional heat plate allows for external standard, quarter-brick heat sink attachment to achieve higher output current in high temperature applications.

Applications

- Hybrid power architectures
- Wireless Networks
- Enterprise Networks including Power over Ethernet (PoE)
- Industrial Equipment

Options

- 1/4th Brick heat plate with threaded inserts

Features

- Compliant to RoHS Directive 2011/65/EU and amended Directive (EU) 2015/863.(-Z versions)
- Compliant to REACH Directive (EC) No 1907/2006
- Small Size and low profile, follows industry standard DOSA 1/4th Brick footprint
58.4 mm x 36.8 mm x 10.2 mm (2.30 in x 1.45 in x 0.40 in)
- Ultra-wide Input Voltage Range, 18V_{dc} to 75V_{dc}
- No minimum load
- High efficiency – 93.5% at full load
- Constant switching frequency
- Low output ripple and noise
- Paste-in-hole reflow compliant for all versions, TH pins and heat plates
- Negative Remote On/Off logic
- Output overcurrent/voltage protection (hiccup)
- Over-temperature protection
- Output Voltage adjust: 90% to 110% of V_{o,nom}
- Suitable for cold wall cooling using heatplate version of the module
- ANSI/UL* 62368-1 and CAN/CSA† C22.2 No. 62368-1 Recognized, DIN VDE‡ 0868-1/A11:2017 (EN62368-1:2014/A11:2017)
- CE mark meets 2014/35/EU directive[§]
- Meets the voltage and current requirements for ETSI 300-132-2 and complies with and licensed for Basic insulation rating
- 2250 V_{dc} Isolation tested in compliance with IEEE 802.3[¶] PoE standards
- ISO**9001 and ISO 14001 certified manufacturing facilities

FOOTNOTES

* Trademark of OmniOn Company

UL is a registered trademark of Underwriters Laboratories, Inc.

† CSA is a registered trademark of Canadian Standards Association.

‡ VDE is a trademark of Verband Deutscher Elektrotechniker e.V.

§ This product is intended for integration into end-user equipment. All of the required procedures of end-use equipment should be followed.

¶ IEEE and 802 are registered trademarks of the Institute of Electrical and Electronics Engineers, Incorporated.

** ISO is a registered trademark of the International Organization of Standards.

Technical Specifications

Absolute Maximum Ratings

Stresses in excess of the absolute maximum ratings can cause permanent damage to the device. These are absolute stress ratings only, functional operation of the device is not implied at these or any other conditions in excess of those given in the operations sections of the Data Sheet. Exposure to absolute maximum ratings for extended periods can adversely affect device reliability.

Parameter	Device	Symbol	Min	Max	Unit
Input Voltage (Continuous)	All	V _{IN}	-0.3	80	V _{dc}
Transient (100ms)	All	V _{IN,trans}	-0.3	100	V _{dc}
Operating Ambient Temperature (see Thermal Considerations section)	All	T _A	-40	85	°C
Storage Temperature	All	T _{stg}	-55	125	°C
Operating altitude (see section on thermal considerations)	All			5000	m
I/O Isolation Voltage (100% factory Hi-Pot tested)	All	-	-	2250	V _{dc}

Electrical Specifications

Unless otherwise indicated, specifications apply at V_{IN} = 48V_{dc}, resistive load, and T_A=25°C conditions with airflow=300LFM apply over all operating input voltage, resistive load, and temperature conditions.

Parameter	Device	Symbol	Min	Typ	Max	Unit
Operating Input Voltage	All	V _{IN}	18	24/48	75	V _{dc}
Input No Load Current V _{IN} = 24V _{dc} , (I _O = 0, module enabled)	All	I _{IN,No load}		180		mA
V _{IN} = 48V _{dc} , (I _O = 0, module enabled)	All	I _{IN,No load}		120		mA
Input Stand-by Current (V _{IN} = 24 to 48V _{dc} , module disabled)	All	I _{IN,stand-by}		8		mA
Maximum Input Current (V _{IN} =18V _{dc} , I _O =I _{O,max})	12.0 V _O				14	A _{dc}
Inrush Transient	All	I ² t			0.1	A ² s
Input Reflected Ripple Current, peak-to-peak (5Hz to 20MHz, 12μH source impedance; V _{IN} =0V to 75V _{dc} , I _O = I _{O,max} ; see Test configuration section)	All			30		mA _{p-p}
Input Ripple Rejection (120Hz)	All			60		dB
EMC, EN55032		See EMC Considerations section				

CAUTION: This power module is not internally fused. An input line fuse must always be used.

This power module can be used in a wide variety of applications, ranging from simple standalone operation to being part of complex power architecture. To preserve maximum flexibility, internal fusing is not included; however, to achieve maximum safety and system protection, always use an input line fuse. The safety agencies require a fast-acting fuse with a maximum rating of 25A (voltage rating 125V_{ac}) in the ungrounded input lead. (Littelfuse Part #0456025, Surface Mount 456 Series - Nano2® or equivalent, see Safety Considerations section)

Technical Specifications (continued)

Electrical Specifications (continued)

Parameter	Device	Symbol	Min	Typ	Max	Unit
Output Voltage Set-point ($V_{IN}=24$ to $48V_{dc}$, $I_O=I_{O, max}$, $T_A=25^{\circ}C$)	12 V_O	$V_{O, set}$	11.82	12.00	12.18	V_{dc} V_{dc}
Output Voltage (Over all operating input voltage, resistive load, and temperature conditions until end of life)	All	V_O	-3.0	—	+3.0	% $V_{O, set}$
Adjustment Range ($*V_{in}>20V$) Selected by external resistor	12 V_O	$V_{O, adj}$	-10		+10*	% $V_{O, set}$
Output Regulation Line ($V_{IN}=V_{IN, min}$ to $V_{IN, max}$) Load ($I_O=I_{O, min}$ to $I_{O, max}$) Temperature ($T_{ref}=T_{A, min}$ to $T_{A, max}$)	All All All		— — —	0.05 0.05 1.0	0.2 0.2 1.5	% $V_{O, set}$ % $V_{O, set}$ % $V_{O, set}$
Output Ripple and Noise on nominal output Measured with 10uF Tantalum 1uF ceramic ($V_{IN}=24$ to $48V_{dc}$, $I_O=80\%I_{O, max}$, $T_A=25^{\circ}C$) RMS (5Hz to 20MHz bandwidth) Peak-to-Peak (5Hz to 20MHz bandwidth)	12 V_O		— —	— —	75 160	mV_{rms} mV_{pk-pk}
External Capacitance	12 V_O	$C_{O, max}$	0	—	5000	μF
Output Current	12 V_O	I_O	0	—	19.0	A_{dc}
Output Current Limit Inception (Hiccup Mode)	12 V_O	$I_{O, lim}$		23	—	A_{dc}
Output Short-Circuit Current $V_O \leq 250$ mV @ $25^{\circ}C$	All	$I_{O, s/c}$	—	1.2		A_{rms}
Efficiency $V_{IN}=24V_{dc}$, $T_A=25^{\circ}C$, $I_O=I_{O, max}$ $V_{IN}=48V_{dc}$, $T_A=25^{\circ}C$, $I_O=I_{O, max}$	12.0 V_O 12.0 V_O	η η		93.5 93	— —	% %
Switching Frequency (Fixed) $V_{IN}=24$ to $48V_{dc}$ and $I_O=I_{O, max}$	All	f_{sw}	—	250	—	kHz
Dynamic Load Response ($\Delta I_O/\Delta t=0.1A/ms$, $V_{IN}=24$ to $48V_{dc}$, $T_A=25^{\circ}C$, $C_O=0\mu F$) Load Change from $I_O=50\%$ to 75% or 25% to 50% of $I_{O, max}$: Peak Deviation Settling Time ($V_O<10\%$ peak deviation)	All All	V_{pk} t_s	— —	3.0 800	— —	% $V_{O, set}$ μs

Isolation Specifications

Parameter	Symbol	Min	Typ	Max	Unit
Isolation Capacitance	C_{iso}	—	1000	—	pF
Isolation Resistance	R_{iso}	10	—	—	$M\Omega$
I/O Isolation Voltage	All	—	—	2250	V_{dc}

Technical Specifications (continued)

General Specifications

Parameter	Min	Typ	Max	Unit
Calculated Reliability based upon Telcordia SR-332 Issue 2: Method I Case 3 ($I_O=80\%I_{O, max}$, $T_A=40^\circ\text{C}$, airflow = 200 lfm, 90% confidence)	FIT	128.7		10 ⁹ /Hours
	MTBF	7,769,746		Hours
Weight (open frame)	—	43.1 (1.52)	—	g (oz.)
Weight (Heat Plate)	—	58 (2.05)	—	g (oz.)

Feature Specifications

Unless otherwise indicated, specifications apply over all operating input voltage, resistive load, and temperature conditions. See Feature Descriptions for additional information.

Parameter	Device	Symbol	Min	Typ	Max	Unit
Remote On/Off Signal Interface ($V_{IN}=V_{IN, min}$ to $V_{IN, max}$; open collector or equivalent, Signal referenced to V_{IN-} terminal) Negative Logic: device code suffix "1" Logic Low = module On, Logic High = module Off Logic Low = module Off, Logic High = module On Logic Low - Remote On/Off Current ($V_{on/off} = -0.7V_{dc}$) Logic Low - On/Off Voltage Logic High Voltage ($I_{on/off} = 0A_{dc}$) Logic High maximum allowable leakage current	All	$I_{on/off}$	-	-	0.15	mA
	All	$V_{on/off}$	-0.7	-	0.6	V_{dc}
	All	$V_{on/off}$	2.5	-	6.7	V_{dc}
	All	$I_{on/off}$	-	-	20	μA
Turn-On Delay and Rise Times ($I_O=80\%$ of $I_{O, max}$, $T_A=25^\circ\text{C}$) Case 1: Input power is applied for at least 1second, and then the On/Off input is set from OFF to ON ($T_{delay} =$ on/off pin transition until $V_O = 10\%$ of $V_{O, set}$) Case 2: On/Off input is set to Module ON, and then input power is applied ($T_{delay} = V_{IN}$ reaches $V_{IN, min}$ until $V_O = 10\%$ of $V_{O, set}$) Output voltage Rise time (time for V_O to rise from 10% of $V_{O, set}$ to 90% of $V_{O, set}$)	All	T_{delay} Case1	-	35		ms
	All	T_{delay} Case2	-	35		ms
	All	T_{rise}	-	20		ms
Output Voltage Overshoot ($I_O=80\%$ of $I_{O, max}$, $V_{IN}= 24$ to $48V_{dc}$, $T_A=25^\circ\text{C}$)					3	% $V_{O, set}$
Output Overvoltage Protection	12.0 V_O	$V_{O, limit}$	13.6 ¹	-	16.6	V_{dc}
Input Undervoltage Lockout Turn-on Threshold Turn-off Threshold Hysteresis	All	$V_{uv/on}$	-	17.5	18	V_{dc}
	All	$V_{uv/off}$	15	15.5	-	V_{dc}
	All	V_{hyst}	1.0	-		V_{dc}

¹ – OVP voltages lower than 13.6Vin for 18-20Vin

Technical Specifications (continued)

Characteristic Curves

The following figures provide typical characteristics for the QHHD019A0B (12V, 19A) at 25 °C.

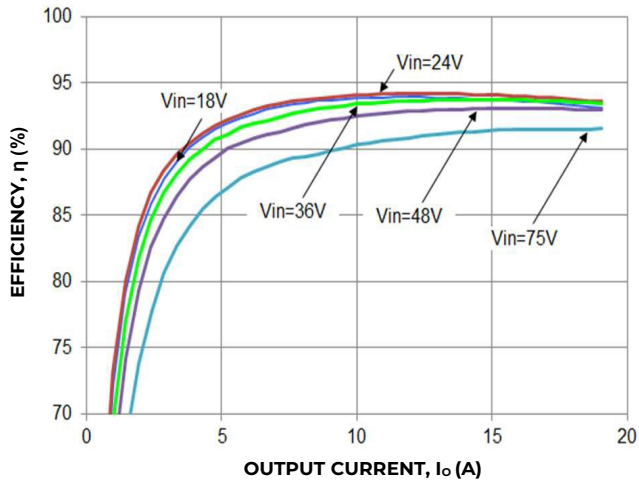

Figure 1. Converter Efficiency versus Output Current.

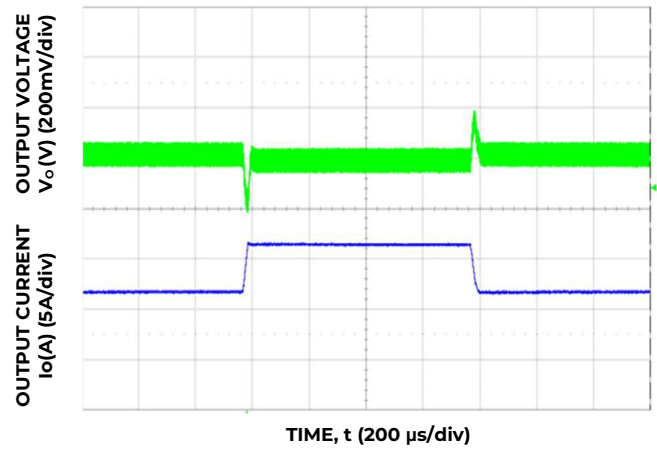

Figure 4. Transient Response to 0.1A/μs Dynamic Load Change from 50% to 75% to 50% of full load, $V_{in}=48V$.

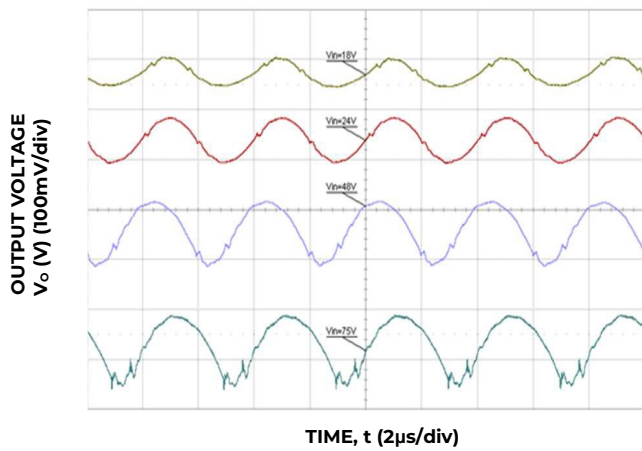

Figure 2. Typical output ripple and noise ($I_o = I_{o,max}$).

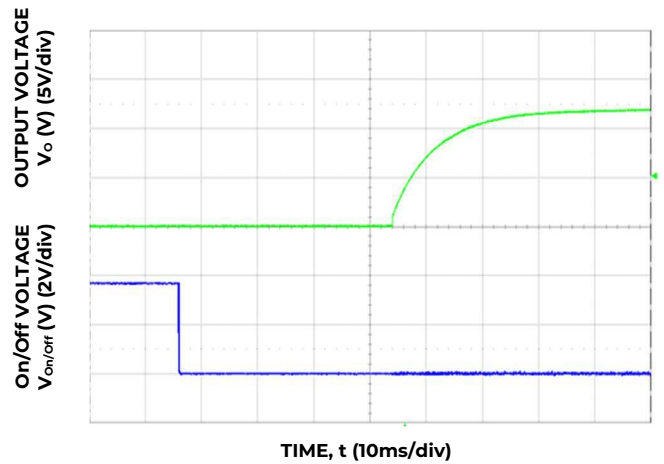

Figure 5. Typical Start-up Using Remote On/Off, negative logic version shown ($V_{IN} = 48V$, $I_o = I_{o,max}$).

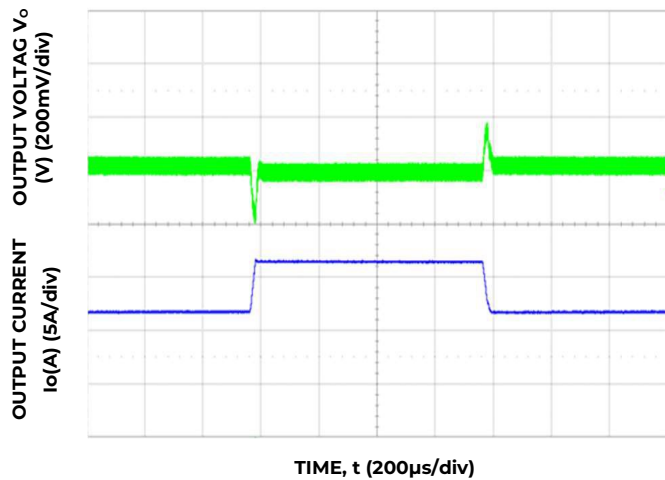

Figure 3. Transient Response to 0.1A/μs Dynamic Load Change from 50% to 75% to 50% of full load, $V_{in}=24V$

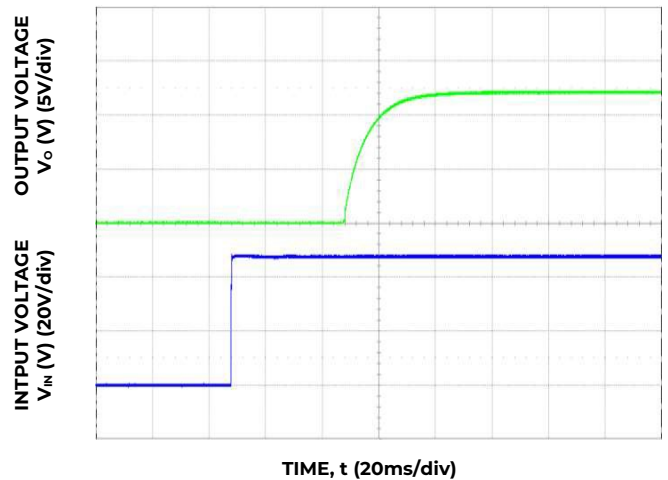

Figure 6. Typical Start-up Using Input Voltage ($V_{IN} = 48V$, $I_o = I_{o,max}$).

Technical Specifications (continued)

Test Configurations

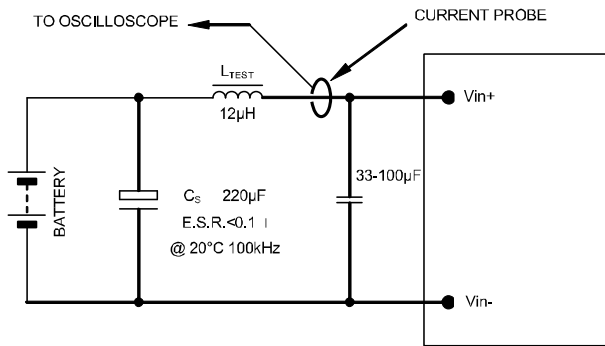

Figure 7. Input Reflected Ripple Current Test Setup.

Note: Measure input reflected-ripple current with a simulated source inductance (L_{TEST}) of $12\ \mu\text{H}$. Capacitor C_s offsets possible battery impedance. Measure current as shown above.

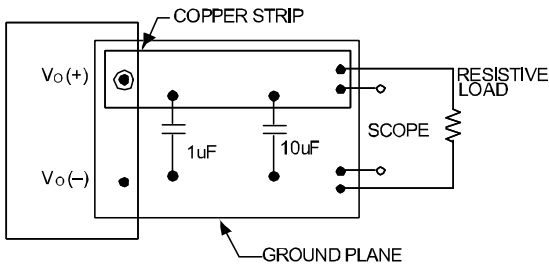
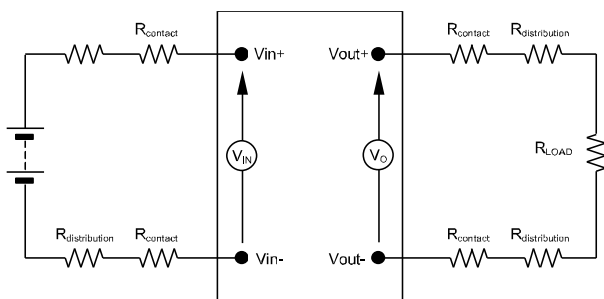

Figure 8. Output Ripple and Noise Test Setup

Note: All voltage measurements to be taken at the module terminals, as shown above. If sockets are used then Kelvin connections are required at the module terminals to avoid measurement errors due to socket contact resistance



Note: All voltage measurements to be taken at the module terminals, as shown above. If sockets are used then Kelvin connections are required at the module terminals to avoid measurement errors due to socket contact resistance

$$\eta = \frac{V_o \cdot I_o}{V_{IN} \cdot I_{IN}} \times 100\%$$

Figure 9. Output Voltage and Efficiency Test Setup.

Design Considerations

Input Source Impedance

The power module should be connected to a low ac-impedance source. Highly inductive source impedance can affect the stability of the power module. For the test configuration in Figure 7, a $220\ \mu\text{F}$ electrolytic capacitor C_{in} ($\text{ESR} < 0.7\ \Omega$ at $100\ \text{kHz}$), mounted close to the power module helps ensure the stability of the unit. Consult the factory for further application guidelines.

Safety Considerations

For safety agency approval the power module must be installed in compliance with the spacing and separation requirements of the end-use safety agency standards, i.e., UL ANSI/UL* 62368-1 and CAN/CSA+ C22.2 No. 62368-1 Recognized, DIN VDE 0868-1/A11:2017 (EN62368-1:2014/A11:2017)

If the input source is non-SELV (ELV or a hazardous voltage greater than $60\ \text{V}_{dc}$ and less than or equal to $75\ \text{V}_{dc}$), for the module's output to be considered as meeting the requirements for safety extra-low voltage (SELV) or ES1, all of the following must be true:

- The input source is to be provided with reinforced insulation from any other hazardous voltages, including the ac mains.
- One V_{IN} pin and one V_{OUT} pin are to be grounded, or both the input and output pins are to be kept floating.
- The input pins of the module are not operator accessible.
- Another SELV or ES1 reliability test is conducted on the whole system (combination of supply source and subject module), as required by the safety agencies, to verify that under a single fault, hazardous voltages do not appear at the module's output.

Note: Do not ground either of the input pins of the module without grounding one of the output pins. This may allow a non-SELV/ES1 voltage to appear between the output pins and ground.

The power module has safety extra-low voltage (SELV) or ES1 outputs when all inputs are SELV or ES1.

For input voltages exceeding $-60\ \text{V}_{dc}$ but less than or equal to $-75\ \text{V}_{dc}$, these converters have been evaluated to the applicable requirements of BASIC INSULATION between secondary DC MAINS DISTRIBUTION input (classified as TNV-2 in Europe) and unearthed SELV outputs.

The input to these units is to be provided with a maximum 15 A fast-acting (or time-delay) fuse in the ungrounded input lead. (Littelfuse Part #0456025, Surface Mount 456 Series Nano2® or equivalent).

Technical Specifications (continued)

Feature Descriptions

Remote On/Off

Negative logic remote on/off, device code suffix “1”, turns the module off during a logic high and on during a logic low.

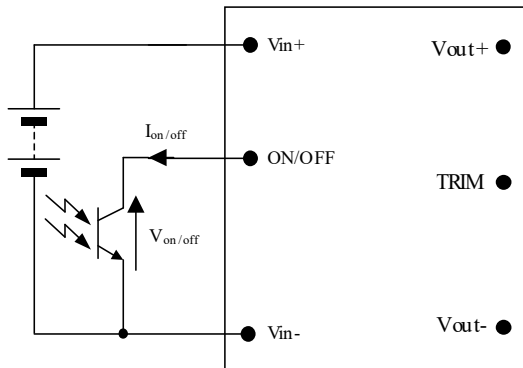

Figure 10. Circuit configuration for using Remote On/Off Implementation.

To turn the power module on and off, the user must supply a switch (open collector or equivalent) to control the voltage ($V_{on/off}$) between the ON/OFF terminal and the $V_{IN(-)}$ terminal. Logic low is $0V \leq V_{on/off} \leq 0.6V$. The maximum $I_{on/off}$ during a logic low is 0.15mA, the switch should be maintain a logic low level whilst sinking this current.

During a logic high, the typical $V_{on/off}$ generated by the module is 5V, and the maximum allowable leakage current at $V_{on/off} = 5V$ is $1\mu A$.

If not using the remote on/off feature:

For negative logic, short the ON/OFF pin to $V_{IN(-)}$.

Remote Sense

Remote sense minimizes the effects of distribution losses by regulating the voltage at the remote-sense connections (See Figure 11). The voltage between the remote-sense pins and the output terminals must not exceed the output voltage sense range given in the Feature Specifications table:

$$[V_o(+)-V_o(-)] - [SENSE(+)-SENSE(-)] \leq 0.5V$$

Although the output voltage can be increased by both the remote sense and by the trim, the maximum increase for the output voltage is not the sum of both. The maximum increase is the larger of either the remote sense or the trim.

The amount of power delivered by the module is defined as the voltage at the output terminals multiplied by the output current.

When using remote sense and trim, the output voltage of the module can be increased, which at the same output current would increase the power output of the module. Care should be taken to ensure that the maximum output power of the module remains at or below the maximum rated power (Maximum rated power = $V_{o,set} \times I_{o,max}$).

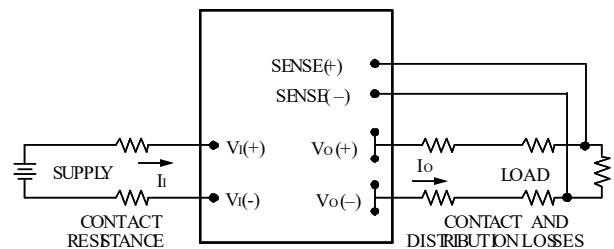

Figure 11. Circuit Configuration for remote sense.

Overcurrent Protection

To provide protection in a fault (output overload) condition, the unit is equipped with internal current-limiting circuitry and can endure current limiting continuously. At the point of current-limit inception, the unit enters hiccup mode. If the unit is not configured with auto-restart, then it will latch off following the over current condition. The module can be restarted by cycling the dc input power for at least one second or by toggling the remote on/off signal for at least one second.

If the unit is configured with the auto-restart option (4), it will remain in the hiccup mode as long as the overcurrent condition exists; it operates normally, once the output current is brought back into its specified range. The average output current during hiccup is 10% $I_{o,max}$.

Overtemperature Protection

To provide protection under certain fault conditions, the unit is equipped with a thermal shutdown circuit. The unit will shutdown if the thermal reference point T_{ref} (Figure 13), exceeds $135^{\circ}C$ (typical), but the thermal shutdown is not intended as a guarantee that the unit will survive temperatures beyond its rating. The module will automatically restart upon cool-down to a safe temperature.

Input Undervoltage Lockout

At input voltages below the input undervoltage lockout limit, the module operation is disabled. The module will only begin to operate once the input voltage is raised above the undervoltage lockout turn-on threshold, $V_{UV/ON}$.

Once operating, the module will continue to operate until the input voltage is taken below the undervoltage turn-off threshold, $V_{UV/OFF}$.

Technical Specifications (continued)

Feature Descriptions (continued)

Output Over Voltage Protection

The output over voltage protection scheme of the modules has an independent over voltage loop to prevent single point of failure. This protection feature latches in the event of over voltage across the output. Cycling the on/off pin or input voltage resets the latching protection feature. If the auto-restart option (4) is ordered, the module will automatically restart upon an internally programmed time elapsing.

Output Voltage Programming

Trimming allows the output voltage set point to be increased or decreased from the default value; this is accomplished by connecting an external resistor between the TRIM pin and either the $V_O(+)$ pin or the $V_O(-)$ pin.

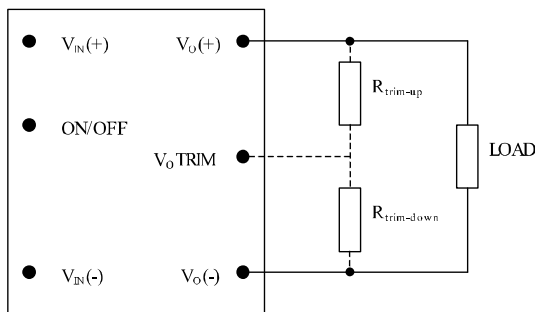

Figure 12. Circuit Configuration to Trim Output Voltage.

Connecting an external resistor ($R_{trim-down}$) between the TRIM pin and the $V_O(-)$ (or Sense(-)) pin decreases the output voltage set point. To maintain set point accuracy, the trim resistor tolerance should be $\pm 1.0\%$.

The following equation determines the required external resistor value to obtain a percentage output voltage change of $\Delta\%$

$$R_{trim-down} = \left[\frac{511}{\Delta\%} - 10.22 \right] \text{ K}\Omega$$

Where
$$\Delta\% = \left(\frac{12.0V - V_{desired}}{12.0V} \right) \times 100$$

Connecting an external resistor ($R_{trim-up}$) between the TRIM pin and the $V_O(+)$ (or Sense (+)) pin increases the output voltage set point. The following equation determines the required external resistor value to obtain a percentage output voltage change of $\Delta\%$:

$$R_{trim-up} = \left[\frac{511 \times 12.0V \times (100 + \Delta\%)}{1.225 \times \Delta\%} - \frac{511}{\Delta\%} - 10.22 \right] \text{ K}\Omega$$

Where
$$\Delta\% = \left(\frac{V_{desired} - 12.0}{12.0} \right) \times 100$$

The voltage between the $V_O(+)$ and $V_O(-)$ terminals must not exceed the minimum output overvoltage protection value shown in the Feature

Specifications table. This limit includes any increase in voltage due to remote-sense compensation and output voltage set-point adjustment trim.

Although the output voltage can be increased by both the remote sense and by the trim, the maximum increase for the output voltage is not the sum of both. The maximum increase is the larger of either the remote sense or the trim. The amount of power delivered by the module is defined as the voltage at the output terminals multiplied by the output current. When using remote sense and trim, the output voltage of the module can be increased, which at the same output current would increase the power output of the module. Care should be taken to ensure that the maximum output power of the module remains at or below the maximum rated power (Maximum rated power = $V_{O,set} \times I_{O,max}$).

Thermal Considerations

The power modules operate in a variety of thermal environments; however, sufficient cooling should be provided to help ensure reliable operation.

Considerations include ambient temperature, airflow, module power dissipation, and the need for increased reliability. A reduction in the operating temperature of the module will result in an increase in reliability.

The thermal data presented here is based on physical measurements taken in a wind tunnel, using automated thermo-couple instrumentation to monitor key component temperatures: FETs, diodes, control ICs, magnetic cores, ceramic capacitors, opto-isolators, and module pwb conductors, while controlling the ambient airflow rate and temperature. For a given airflow and ambient temperature, the module output power is increased, until one (or more) of the components reaches its maximum derated operating temperature, as defined in IPC- 9592. This procedure is then repeated for a different airflow or ambient temperature until a family of module output derating curves is obtained.

Technical Specifications (continued)

Feature Descriptions (continued)

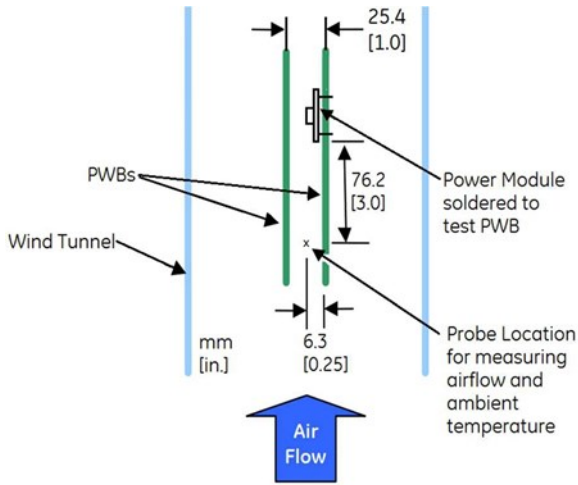

The thermal reference points, T_{ref1} , and T_{ref2} used in the specifications for open frame modules are shown in Figure 13. For reliable operation these temperatures should not exceed 124°C & 124°C respectively.

For altitude adjustment the following equations should be applied:

$$T_{alt} = T_{sea} + \Delta T$$

$$\Delta T = (T_{sea} - T_{amb}) \left[\left(\frac{\rho_{sea}}{\rho_{alt}} \right)^5 - 1 \right]$$

where:

T_{sea} is the comp./ T_{ref} temperature at sea level measurement

T_{amb} is the temperature at the operating altitude

ρ_{sea} is the density of air at sea level,

ρ_{alt} is the density of air at the chosen altitude

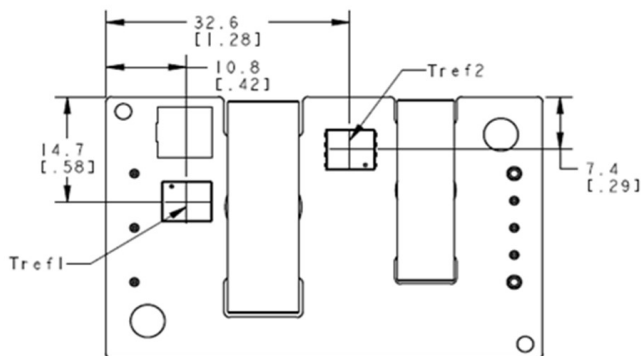

Figure 13. T_{ref} Temperature Measurement Location for open frame version.

The thermal reference point, T_{ref} used in the specifications is shown in Figure 14. For reliable operation these temperatures should not exceed 105 °C

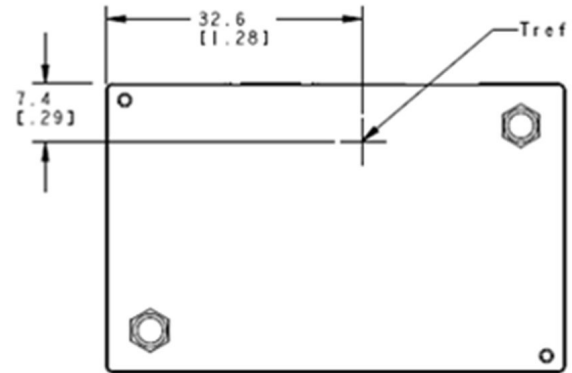

Figure 14. T_{ref} Temperature Measurement Location for heat plate version.

The thermal reference points, T_{ref1} , and T_{ref2} used in the specifications is shown in Figure 15. For reliable operation these temperatures should not exceed 100° C & 125°C respectively.

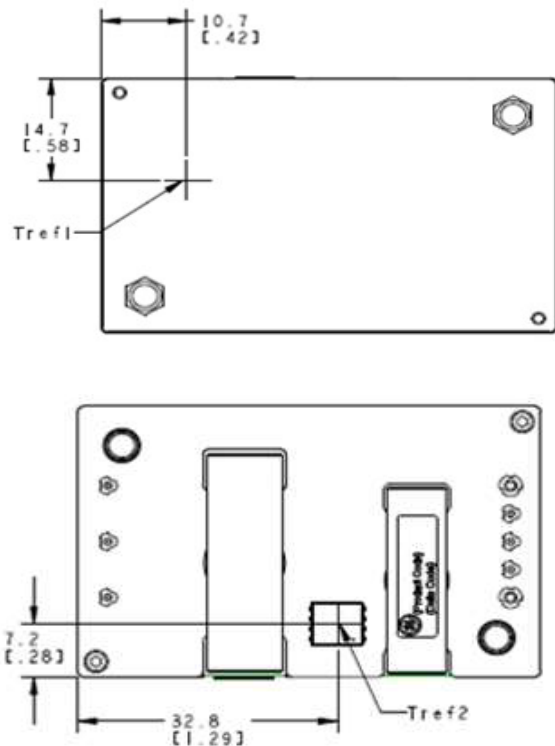

Figure 15. T_{ref} Temperature Measurement Location for coldwall applications version.

Technical Specifications (continued)

Heat Transfer via Convection

Increased airflow over the module enhances the heat transfer via convection. Derating figures showing the maximum output current that can be delivered by each module versus local ambient temperature (T_A) for natural convection and up to 3m/s (600 ft./min) are shown in in Figures 16 - 22.

Please refer to the Application Note “Thermal Characterization Process For Open-Frame Board-Mounted Power Modules” for a detailed discussion of thermal aspects including maximum device temperatures.

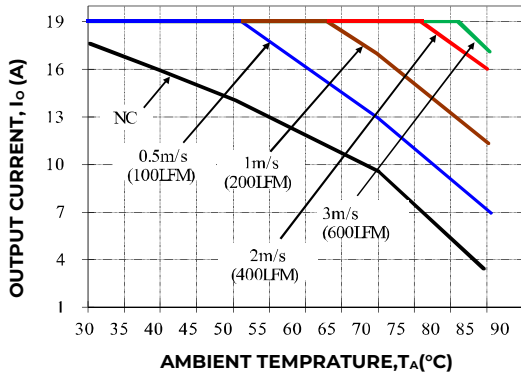

Figure 16. Output Current Derating for the Open Frame Module; Airflow in the Transverse Direction from $V_{out}(+)$ to $V_{out}(-)$; $V_{IN} = 48V$, $V_O = 12V$.

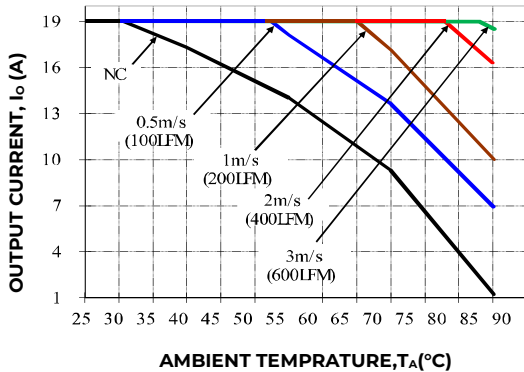

Figure 17. Output Current Derating for the Module with Heatplate; Airflow in the Transverse Direction from $V_{out}(+)$ to $V_{out}(-)$; $V_{IN} = 48V$, $V_O = 12V$

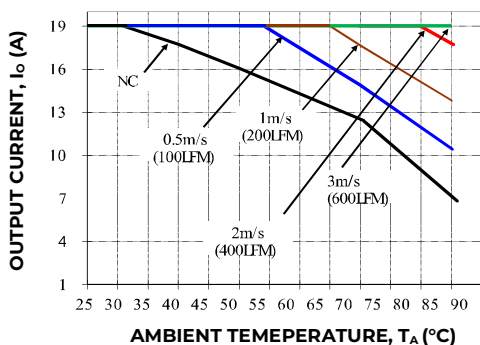

Figure 18. Output Current Derating for the Open Frame Module; Airflow in the Transverse Direction from $V_{out}(+)$ to $V_{out}(-)$; $V_{IN} = 24V$, $V_O = 12V$.

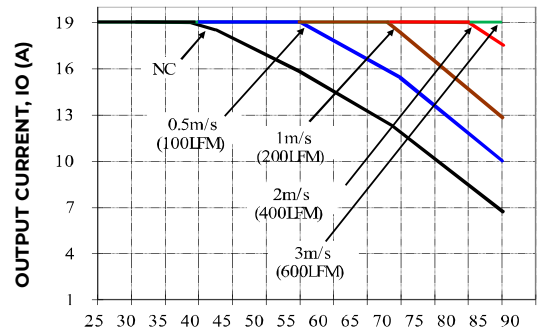

Figure 19. Output Current Derating for the Module with Heatplate; Airflow in the Transverse Direction from $V_{out}(+)$ to $V_{out}(-)$; $V_{IN} = 24V$, $V_O = 12V$.

Heat Transfer via Conduction

The module can also be used in a sealed environment with cooling via conduction from the module's top surface through a heat plate to a cold wall, as shown in Figure 20. The output current derating versus cold wall temperature, when using thermal pad/grease is shown in Figure 21.

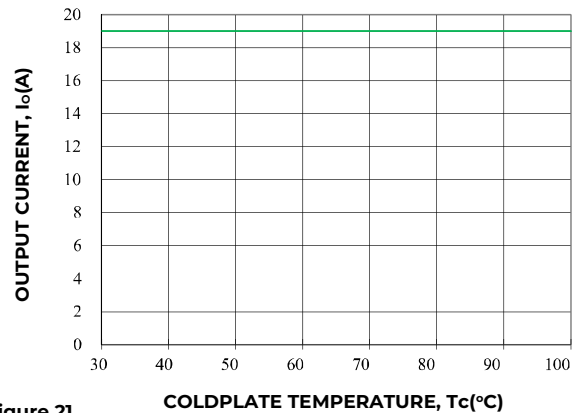

Figure 21. Derated Output Current versus Cold Wall Temperature with local ambient temperature around module at 75°C; $V_{IN} = 24V$ or 48V.

Through-Hole Soldering Information

Lead-Free Soldering

The RoHS-compliant (Zcodes) through-hole products use the SAC (Sn/Ag/Cu) Pb-free solder and RoHS-compliant components. They are designed to be processed through single or dual wave soldering machines or reflow soldering processes. The pins have an RoHS-compliant finish that is compatible with both Pb and Pbfree wave soldering processes. A maximum preheat rate of 3°C/s is suggested.

The wave preheat process should be such that the temperature of the power module board is kept below

Technical Specifications (continued)

210°C. For Pb solder, the recommended pot temperature is 260°C, while the Pb-free solder pot is 270°C max. If additional information is needed, please consult with your OmniOn Energy representative for more details.

Paste-in-Hole Soldering

The QHHD019A0Bxx and the QHHD019A0B xx-HZ module is compatible with reflow paste-in-hole soldering processes shown in Figures 22-23. Please contact your OmniOn Sales Representative for further information.

MSL Rating

The QHHD_225W series modules have a MSL rating of 2a.

Tin Lead Soldering

The QHHD019A0B power modules are lead free modules and can be soldered either in a lead-free solder process or in a conventional Tin/Lead (Sn/Pb) process. It is recommended that the customer review data sheets in order to customize the solder reflow profile for each application board assembly. The following instructions must be observed when soldering these units. Failure to observe these instructions may result in the failure of or cause damage to the modules, and can adversely affect longterm reliability.

In a conventional Tin/Lead (Sn/Pb) solder process peak reflow temperatures are limited to less than 235°C. Typically, the eutectic solder melts at 183°C, wets the land, and subsequently wicks the device connection. Sufficient time must be allowed to fuse the plating on the connection to ensure a reliable solder joint. For reliable soldering the solder reflow profile should be established by accurately measuring the modules CP connector temperatures.

Lead Free Soldering

The -Z version of the QHHD019A0B modules are lead-free (Pbfree) and RoHS compliant and are both forward and backward compatible in a Pb-free and a SnPb soldering process. Failure to observe the instructions below may result in the failure of or cause damage to the modules and can adversely affect long-term reliability.

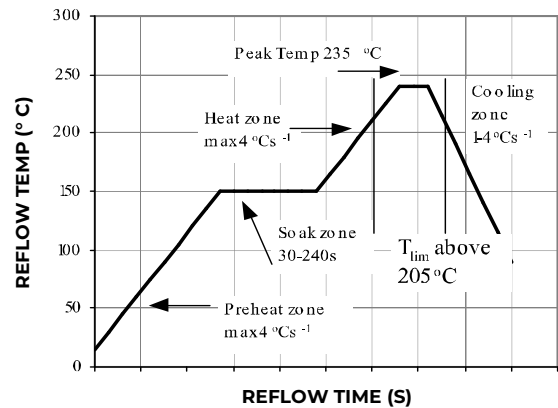

Figure 22. Reflow Profile for Tin/Lead (Sn/Pb) process.

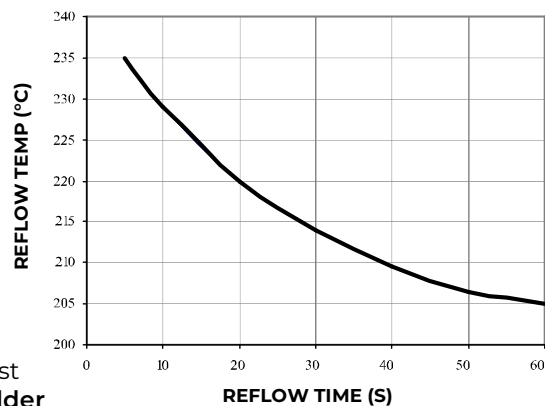

Figure 23. Time Limit Curve Above 205°C for Tin/Lead (Sn/Pb) process

Cleaning and Drying Considerations

Post solder cleaning is usually the final circuit-board assembly process prior to electrical board testing. The result of inadequate cleaning and drying can affect both the reliability of a power module and the testability of the finished circuit-board assembly. For guidance on appropriate soldering, cleaning and drying procedures, refer to OmniOn Board Mounted Power Modules: Soldering and Cleaning Application Note (AN04-001).

Layout Considerations

The QHHD_225W power module series are low profile in order to be used in fine pitch system card architectures. As such, component clearance between the bottom of the power module and the mounting board is limited. Avoid placing copper areas on the outer layer directly underneath the power module. Also avoid placing via interconnects underneath the power module. For additional layout guide-lines, refer to the FLT012A0 data sheet.

Technical Specifications (continued)

EMC Requirements

Figure 24 shows a maximum filter configuration to meet the conducted emission limits of EN55032 Class A.

Notes: C1 is a low impedance 100V SMT ceramics. C4 and C5 are low impedance >1500V ceramics.

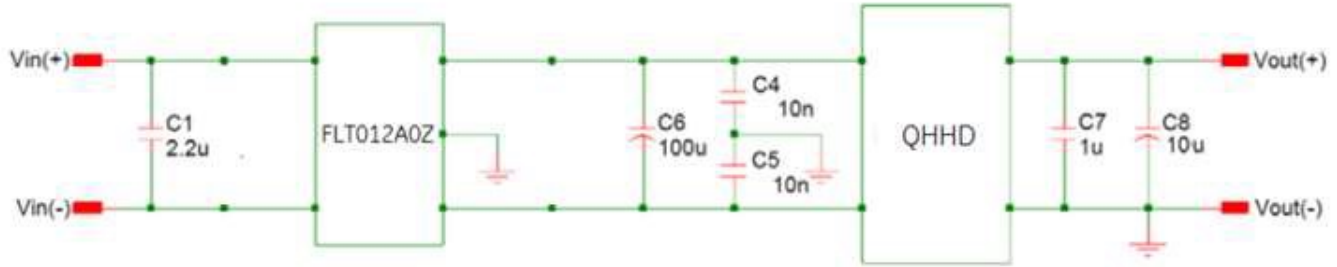
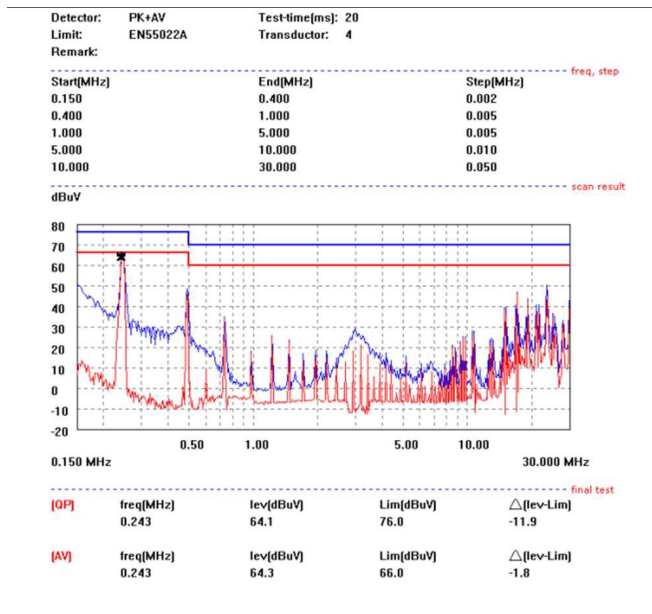
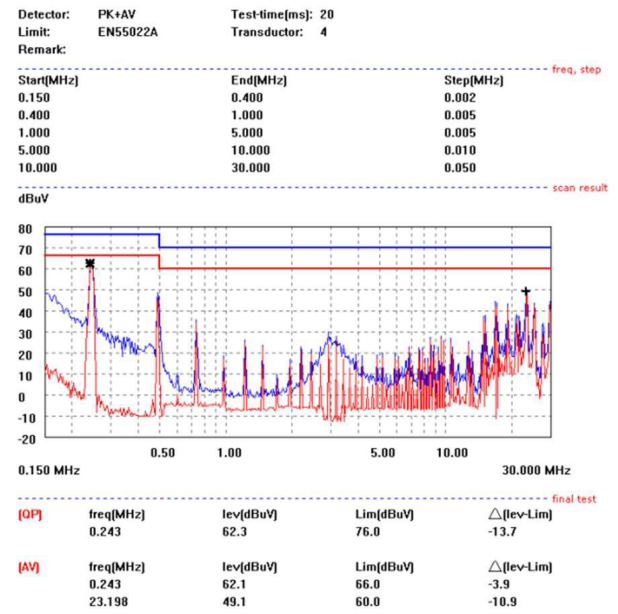

Figure 24. Suggested Configuration for EN55032 Class A.

For further information on designing for EMC compliance, please refer to the FLT012A0Z data sheet



V_{IN} = 48V, I_o = I_{o,max}, L Line



V_{IN} = 48V, I_o = I_{o,max}, N Line

Technical Specifications (continued)

EMC Requirements

Figure 25 shows a maximum filter configuration to meet the conducted emission limits of EN55032 Class B. Notes: C1, C2, C3, C4 are low impedance 100V SMT ceramics. C5 and C6 are low impedance >1500V ceramics.

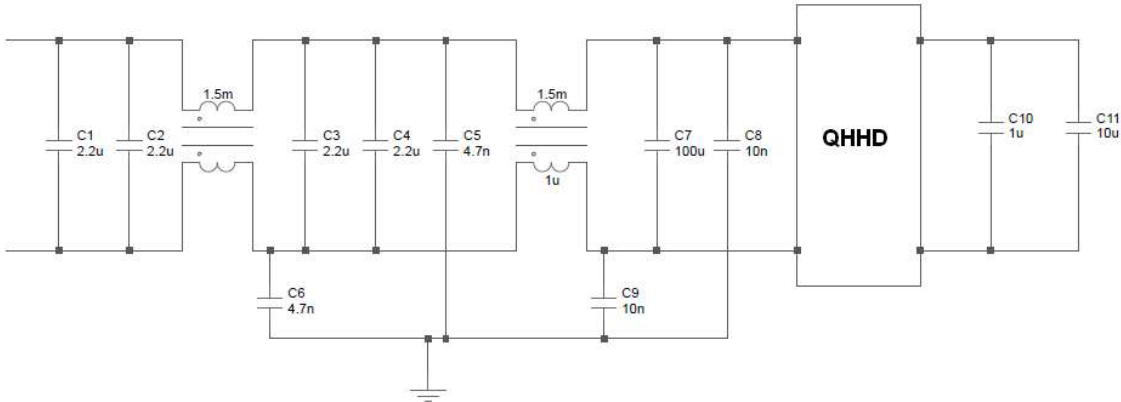
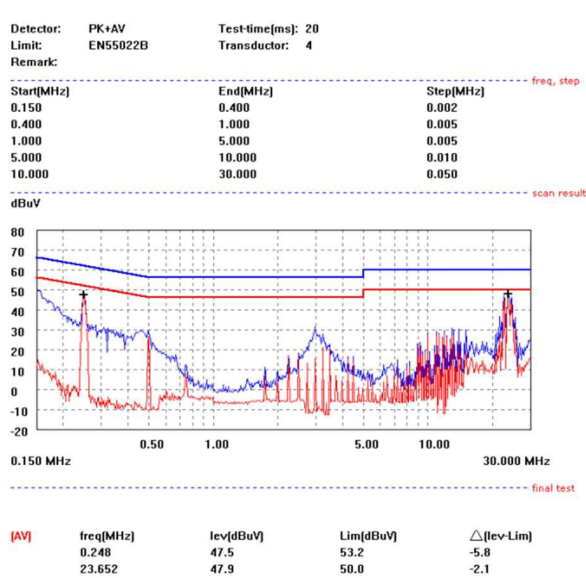
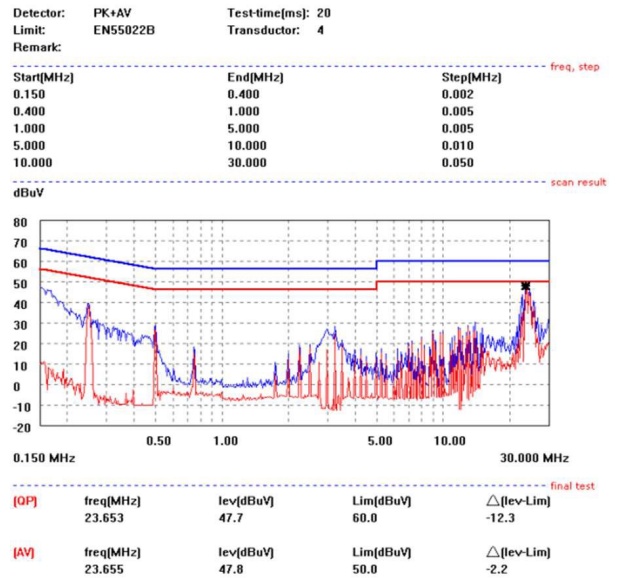

Figure 25. Suggested Configuration for EN55032 Class B.



V_{IN} = 48V, I_o = I_{o,max}, L Line



V_{IN} = 48V, I_o = I_{o,max}, N Line

Technical Specifications (continued)

Mechanical Outline for Through-Hole Module (Open Frame)

Dimensions are in millimeters and [inches].

Tolerances: x.x mm ± 0.5 mm [x.xx in. ± 0.02 in.] (Unless otherwise indicated)

x.xx mm ± 0.25 mm [x.xxx in. ± 0.010 in.]

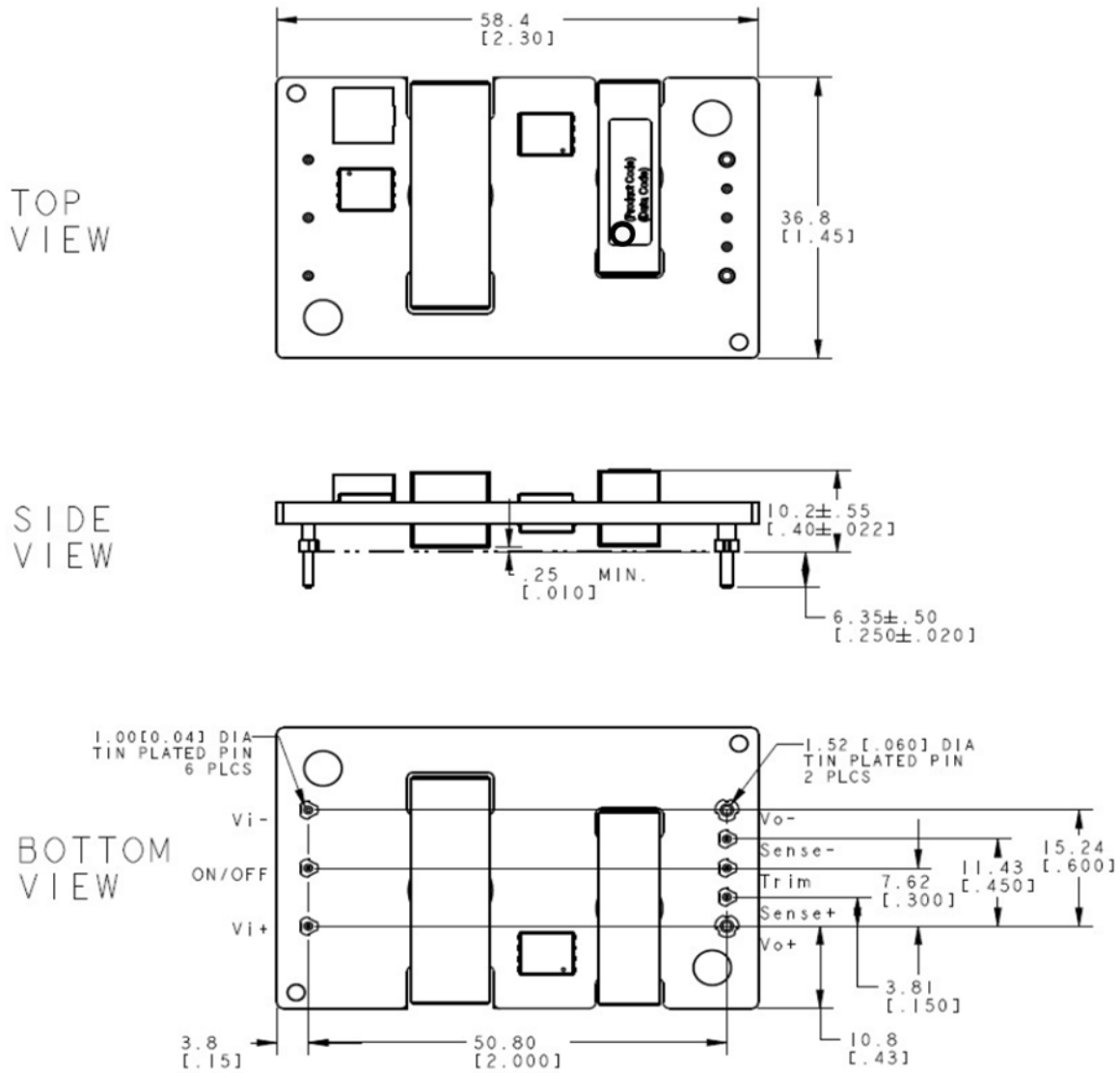

Pin	Function
1	V _i (+)
2	ON/OFF
3	V _i (-)
4	V _o (-)
5	SENSE(-)
6	TRIM
7	SENSE(-)
8	V _o (+)

Technical Specifications (continued)

Mechanical Outline for Through Hole Module with heat plate (-H, Option)

Dimensions are in millimeters and [inches].

Tolerances: x.x mm ±0.5 mm [x.xx in. ±0.02 in.] (Unless otherwise indicated)

x.xx mm ± 0.25 mm [x.xxx in ± 0.010 in.]

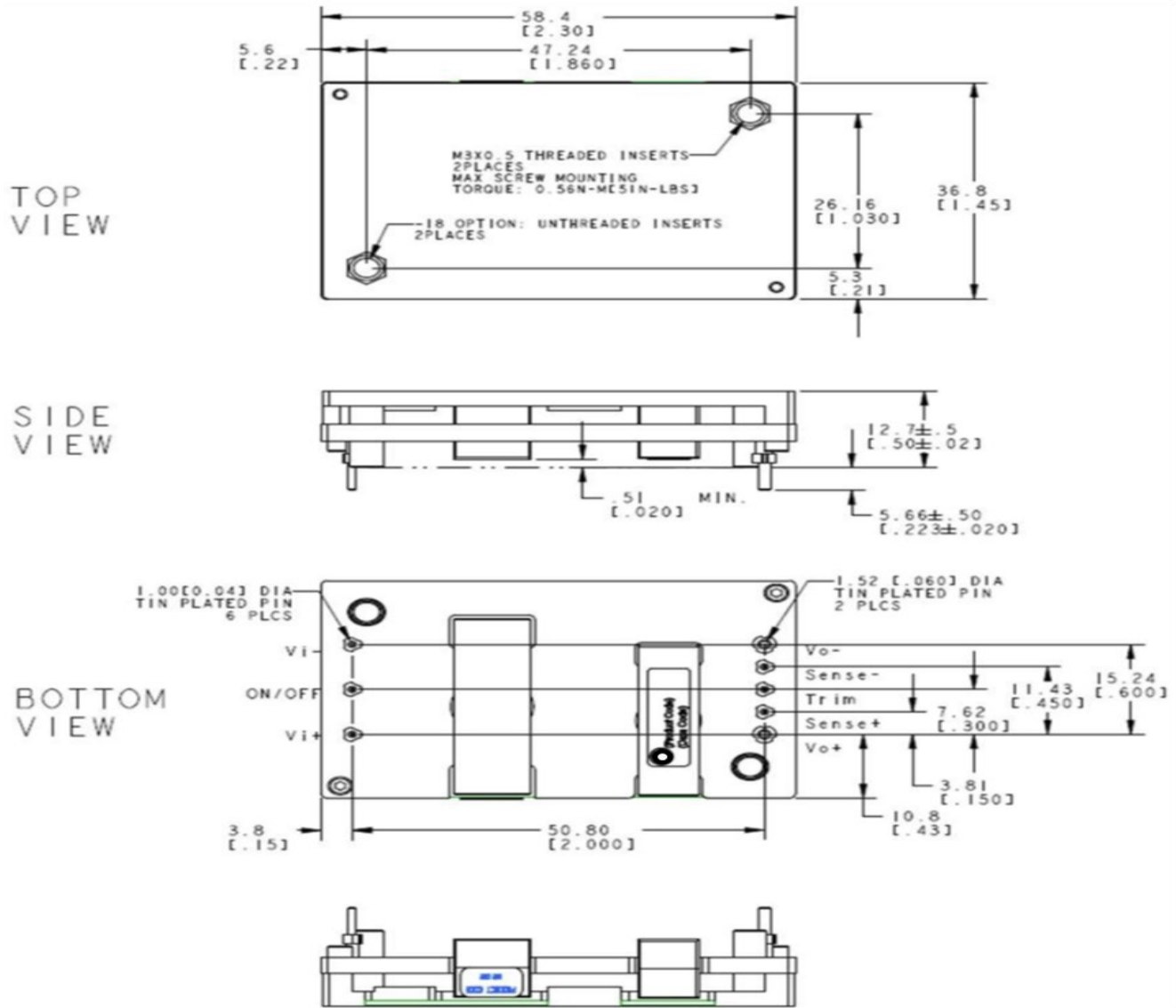

Pin	Function
1	Vi(+)
2	ON/OFF
3	Vi(-)
4	Vo(-)
5	SENSE(-)
6	TRIM
7	SENSE(-)
8	Vo(+)

Technical Specifications (continued)

Recommended Pad Layout for Through Hole Module

Dimensions are in millimeters and (inches).

Tolerances: x.x mm ± 0.5 mm [x.xx in. ± 0.02 in.] (unless otherwise indicated)

x.xx mm ± 0.25 mm [x.xxx in ± 0.010 in.]

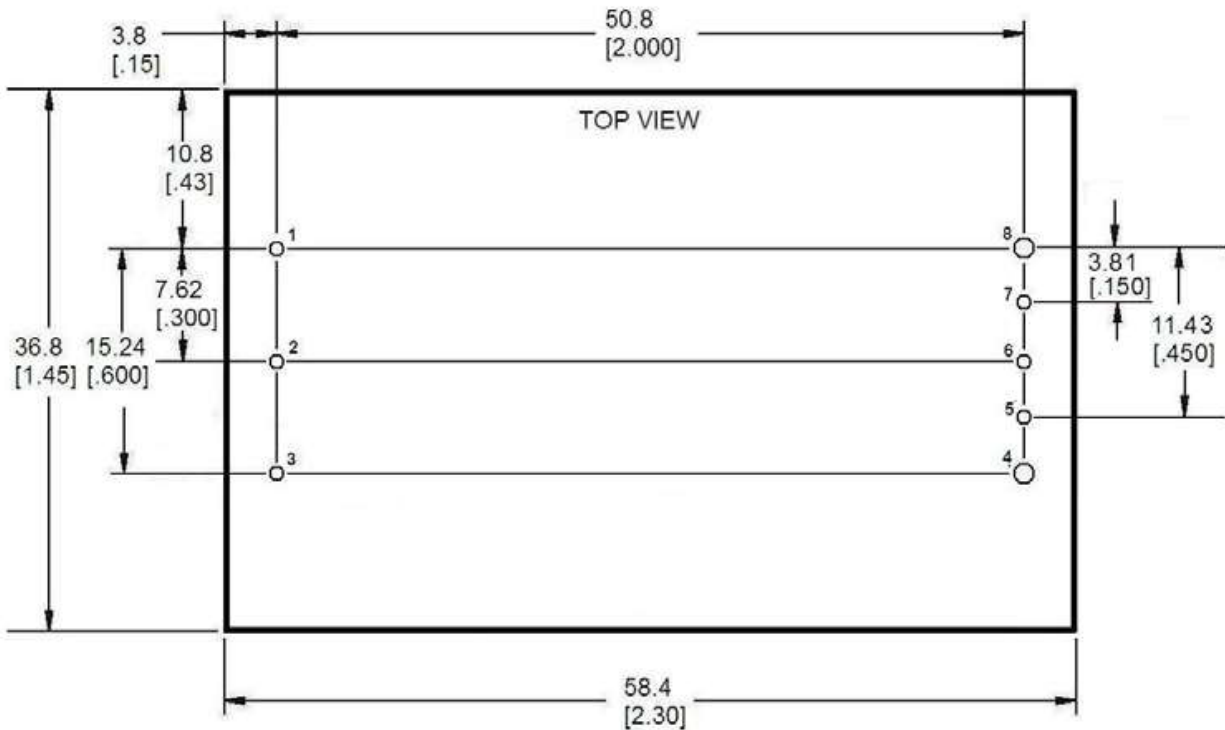

Pin Number	Pin Name
1	V _{IN} (+)
2	ON/OFF
3	V _{IN} (-)
4	V _{OUT} (-)
5	SENSE(-)
6	TRIM
7	SENSE(-)
8	V _{OUT} (+)

Hole and Pad diameter recommendations:

Pin Number	Hole Dia (mm)	Pad Dia (mm)
1-3,5-7	1.6	2.1
4, 8	2.2	3.2

Technical Specifications (continued)

Packaging Details

The open frame versions of the QHHD019A0B are supplied as standard in the plastic trays shown in Figure 26.

Tray Specification

Material	PET (1mm)
Max surface resistivity	$10^9 - 10^{11} \Omega/\text{sq}$
Color	Clear
Capacity	12 power modules
Min order quantity	24 pcs (1 box of 2 full trays + 1 empty top tray)

Each tray contains a total of 12 power modules. The trays are self-stacking and each shipping box the QHHD019A0B through hole module will contain 2 full trays plus one empty hold down tray giving a total number of 24 power

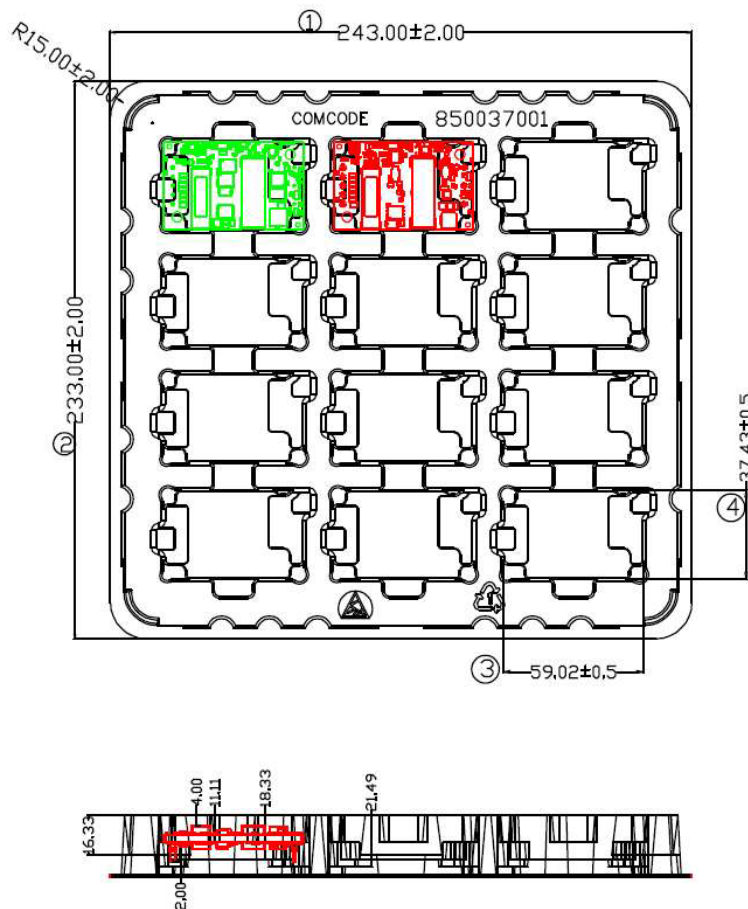

Figure 26. Open Frame Through Hole Packaging Tray

Technical Specifications (continued)

Packaging Details

The Heat Plate versions of the QHHD019A0B (suffix -H) are supplied as standard in the plastic trays shown in Figure 27.

Tray Specification

Material	PET (1mm)
Max surface resistivity	$10^9 - 10^{11} \Omega/\text{sq}$
Color	Clear
Capacity	12 power modules
Min order quantity	24 pcs (1 box of 2 full trays + 1 empty top tray)

Each tray contains a total of 12 power modules. The trays are self-stacking and each shipping box the QHHD019A0B (suffix -H) through hole module will contain 2 full trays plus one empty hold down tray giving a total number of 24 power

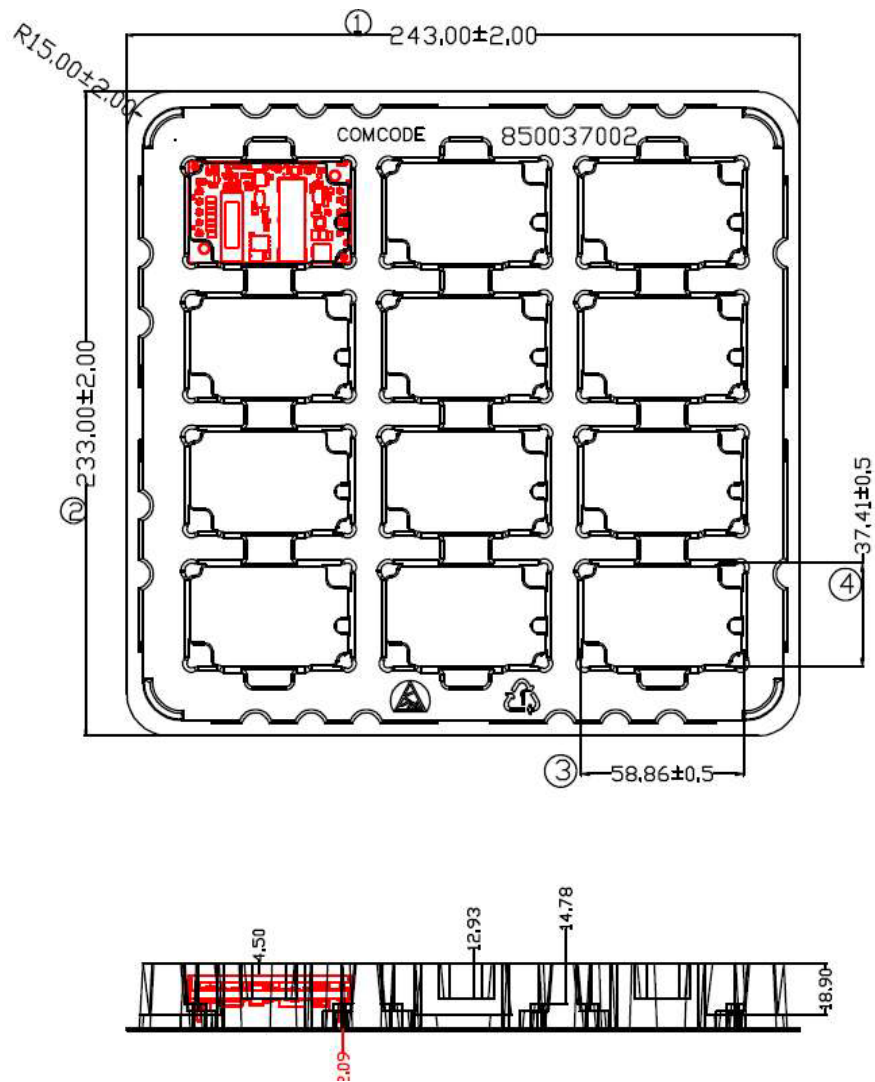

Figure 27. Heat Plate version Packaging Tray

Technical Specifications (continued)

Ordering Information

Please contact your OmniOn Sales Representative for pricing, availability and optional features.

Product codes	Input Voltage	Output Current	Output Voltage	Remote On/Off Logic	Connector Type	Ordering Codes
QHHD019A0B41Z	24V/48V (18-75V _{dc})	19.0A	12.0V	Negative	Through hole	150029667
QHHD019A0B41-HZ	24V/48V (18-75V _{dc})	19.0A	12.0V	Negative	Through hole	150030812
QHHD019A0B641-HZ	24V/48V (18-75V _{dc})	19.0A	12.0V	Negative	Through hole	150037357
QHHD019A0B641-DHZ ¹	24V/48V (18-75V _{dc})	19.0A	12.0V	Negative	Through hole	1600321586A
QHHD019A0B641-DZ ¹	24V/48V (18-75V _{dc})	19.0A	12.0V	Negative	Through hole	1600375580A

Table 1. Device Codes.

¹ Polyurethane Conformal coating on both sides is included for the -D option. The -D version is not compatible with paste-in-hole reflow soldering. Contact your OmniOn sales representative for more information.

	Characteristic	Character and Position										Definition		
Ratings	Form Factor	Q											Q=1/4th Brick	
	Family Designator	H	H										HH= Hammerhead™ Series	
	Input Voltage		D										D= UltraWide Range, 18V-75V	
	Output Current			019A0									019A0 =019.0 Amps Maximum Output Current	
	Output Voltage				B								B=12V nominal	
Options	Pin Length									6	8		Omit = Default Pin Length shown in Mechanical Outline Figures 6 = Pin Length: 3.68 mm ± 0.25mm, (0.145 in. ± 0.010 in.) 8 = Pin Length: 2.79 mm ± 0.25mm, (0.110 in. ± 0.010 in.)	
	Action following Protective Shut-down									4			4 = Auto-restart following shutdown (Overcurrent/Over-voltage) Must be ordered	
	On/Off Logic									1			Omit= Positive Logic 1 = Negative Logic	
											-			
	Customer Specific											X Y	XY= Customer Specific Modified Code, Omit for Standard Code	
	Mechanical Features												D	Omit= Standard open Frame Module D = Polyurethane Conformal coating on both sides. Not compatible with paste-in-hole reflow soldering.
													H	H=1/4th Brick size heat plate, for use with heat sinks (not available with -S option)
RoHS												Z	Omit=RoHS 5/6, Lead Based Solder Used Z = RoHS Compliant,	

Table 2. Device Options.

Contact Us

For more information, call us at

+1-877-546-3243 (US)

+1-972-244-9288 (Int'l)

Change History (excludes grammar & clarifications)

Revision	Date	Description of the change
1.7	04-08-2022	Updated as per template, ROHS
1.8	04-04-2023	Added New Ordering Codes
1.9	11-07-2023	Updated as per OmniOn template

OmniOn Power Inc.

601 Shiloh Rd.
Plano, TX USA

omnionpower.com

We reserve the right to make technical changes or modify the contents of this document without prior notice. OmniOn Power does not accept any responsibility for errors or lack of information in this document and makes no warranty with respect to and assumes no liability as a result of any use of information in this document.

Page 22

© 2023 OmniOn Power Inc. All rights reserved.

We reserve all rights in this document and in the subject matter and illustrations contained therein. Any reproduction, disclosure to third parties or utilization of its contents – in whole or in parts – is forbidden without prior written consent of OmniOn Power. This document does not convey license to any patent or any intellectual property right. Copyright© 2023 OmniOn Power Inc. All rights reserved.

QHHD019A0B_DS

Rev. 1.9