

CPL-SYSTEM -48V Power System

19" CPL-SYSTEM with J8314530 Distribution

Example configuration is shown below. There are other possible configurations.



CPL48-19-AC5H-PS16-DC1E

- **SAVE THESE INSTRUCTIONS** – This document contains important safety and operating instructions for the CP distribution system.
- Equipment is intended for installation only in restricted access areas.
- **Rules and Regulations** - Follow all national and local rules and regulations when making field connections.
- This equipment is not suitable for use in locations where children are likely to be present.
- **SAUVEGARDEZ CES INSTRUCTIONS** – Ce document contient des instructions de sécurité et d'utilisation importantes pour le système de distribution CP.
- L'équipement est destiné à être installé uniquement dans des zones à accès restreint.
- **Règles et règlements** - Suivez toutes les règles et réglementations nationales et locales lorsque vous établissez des connexions sur le terrain.
- Cet équipement ne convient pas à une utilisation dans des endroits où des enfants sont susceptibles d'être présents.

Document – 8600484448P

Safety Statements

- Do not install this equipment over combustible surfaces.
- Rules and Regulations – Follow all national and local rules and regulations when making field connections.
- Compression Connectors
 - U. S. or Canada installations – use Listed/Certified compression connectors to terminate Listed/Certified field – wire conductors.
 - All installations – apply the appropriate connector to the correct size conductor as specified by the connector manufacturer, using only the connector manufacturer’s recommended or approved tooling for that connector.
- Electrical Connection Securing: Torque to the values specified on labels or in the product documentation.
- Cable Dress – dress to avoid damage to the conductors and undue stress on the connectors.
- Field – wired Conductors – Follow all National Electric Code (NEC) and local rules and regulations.
 - Insulation rating: 90°C minimum; 105°C (minimum) if internal to enclosed equipment cabinets.
 - Size AC field-wired conductors with 75°C ampacity (NEC) equal to or greater than their panel board circuit breaker rating.
- AC and DC input disconnect/protection – Provide accessible devices to remove input power in an emergency.
- Grounding – Connect the equipment chassis directly to ground. In enclosed equipment cabinets connect to the cabinet AC service ground bus. In huts, vaults, and central offices connect to the system bonding network.
- Do not place combustible materials directly above or below equipment.

Note: Proper grounding of AC supply receptacles must be verified by qualified personnel.

- An all-pole mains switch is required as part of the building installation for equipment constructed with terminal block style AC input
- Short Circuit Current Rating for J8314530 shelves: 10kA
- Alarm contacts provided are not fused within the subject power distribution shelves. Current limiting protection for these contacts must be provided by external circuits and limit the input to a maximum of 0.5A at 60Vdc.
- Terminal block style AC input requires a minimum 10AWG supply conductor. Terminal block adapter style AC input requires a minimum 8AWG for supply conductors and must have a minimum 8AWG external bonding conductor.
- Ambient Temperature Rating: 45°C with a 2%/°C derating up to 55°C.

For additional safety information, see the following documents:

Ordering Code	Description
CPL-SYSTEMS-AD	CPL-SYSTEMS Configuration drawing
CC848815341	Galaxy Pulsar Plus Product Manual
8600482319P	J5964805 Power Shelf Safety QSG

Énoncés de sécurité

- N'installez pas cet équipement sur des surfaces combustibles.
- Règles et règlements – Suivez toutes les règles et réglementations nationales et locales lorsque vous établissez des connexions sur le terrain.
- Connecteurs de compression
 - Installations aux États-Unis ou au Canada – utilisez des connecteurs de compression répertoriés/certifiés pour terminer les conducteurs de fil de champ répertoriés/certifiés.
 - Toutes les installations – appliquez le connecteur approprié au conducteur de taille correcte spécifié par le fabricant du connecteur, en utilisant uniquement l'outillage recommandé ou approuvé par le fabricant du connecteur pour ce connecteur.
- Sécurisation de la connexion électrique : Couple aux valeurs spécifiées sur les étiquettes ou dans la documentation du produit.
- Robe de câble – habillez-vous pour éviter d'endommager les conducteurs et de solliciter inutilement les connecteurs.
- Conducteurs câblés sur le terrain – Respectez toutes les règles et réglementations nationales du Code national de l'électricité (NEC) et locales.
 - Indice d'isolation : 90°C minimum ; 105 °C (minimum) si interne aux armoires d'équipement fermées.
 - Taille des conducteurs câblés sur le terrain AC avec une ampacité de 75°C (NEC) égale ou supérieure à leur circuit nominal de carte de panneau.
- Débranchement/protection des entrées CA et CC – Fournissez des dispositifs accessibles pour couper l'alimentation d'entrée en cas d'urgence.
- Mise à la terre – Connectez le châssis de l'équipement directement à la terre. Dans les armoires d'équipement fermées, connectez-vous au bus de masse de service CA de l'armoire. Dans les huttes, les chambres fortes et les bureaux centraux se connectent au réseau de liaison du système.
- Ne placez pas de matières combustibles directement au-dessus ou au-dessous de l'équipement.

Remarque: La mise à la terre adéquate des prises d'alimentation en courant alternatif doit être vérifiée par du personnel qualifié.

- Un interrupteur secteur omnipolaire est requis dans le cadre de l'installation du bâtiment pour les équipements construits avec une entrée CA de type bornier.
- Courant nominal de court-circuit pour les étagères J8314530 : 10 kA
- Les contacts d'alarme fournis ne sont pas fusionnés dans les étagères de distribution électrique en question. La protection de limitation de courant pour ces contacts doit être assurée par des circuits externes et limiter l'entrée à un maximum de 0,5 A à 60 V CC.
- L'entrée CA de type bornier nécessite un conducteur d'alimentation minimum de 10 AWG. L'entrée CA de type adaptateur de bornier nécessite un minimum de 8 AWG pour les conducteurs d'alimentation et doit avoir un conducteur de liaison externe d'au moins 8 AWG.
- Température ambiante nominale : 45°C avec un déclassement de 2 %/°C jusqu'à 55°C.

Pour des informations de sécurité supplémentaires, consultez les documents suivants :

Ordering Code	Description
CPL-SYSTEMS-AD	CPL-SYSTEMS Configuration drawing
CC848815341	Product Manual for Pulsar Plus Controller Family
8600482319P	J5964805 Power Shelf Safety QSG

Precautions

- Install, service, and operate equipment only by professional, skilled and qualified personnel who have the necessary knowledge and practical experience with electrical equipment and who understand the hazards that can arise when working on this type of equipment.
- Do not disconnect permanent bonding connections unless all power inputs are disconnected.
- Verify that equipment is properly safety earth grounded before connecting power. High leakage currents may be possible.
- Exercise care and follow all safety warnings and practices when servicing this equipment. Hazardous energy and voltages are present in the unit and on the interface cables that can shock or cause serious injury.
- Use the following precautions in addition to proper job training and safety procedures:
 - Use only properly insulated tools.
 - Remove all metallic objects (key chains, glasses, rings, watches, or other jewelry).
 - Follow Lock Out Tag Out (LOTO) procedures: customer specified, site specific, or general as appropriate. Disconnect all power input before servicing the equipment. Check for multiple power inputs.
 - Wear safety glasses.
 - Follow Personal Protective Equipment requirements: customer specified, site specific, or general as appropriate.
 - Test circuits before touching.
 - Be aware of potential hazards before servicing equipment.
 - Identify exposed hazardous electrical potentials on connectors, wiring, etc.
 - Avoid contacting circuits when removing or replacing covers;.
 - Use a personal ESD strap when accessing or removing electronic components.
- Personnel with electronic medical devices need to be aware that proximity to DC power and distribution systems, including batteries and cables, typically found in telecommunications utility rooms, can affect medical electronic devices, such as pacemakers. Effects decrease with distance.

Précautions

- Installer, entretenir et utiliser l'équipement uniquement par du personnel professionnel, qualifié et qualifié qui possède les connaissances et l'expérience pratique nécessaires avec l'équipement électrique et qui comprend les dangers qui peuvent survenir lors du travail sur ce type d'équipement.
- Ne débranchez pas les connexions de liaison permanentes à moins que toutes les entrées d'alimentation ne soient déconnectées.
- Vérifiez que l'équipement est correctement mis à la terre avant de brancher l'alimentation. Des courants de fuite élevés peuvent être possibles.
- Faites preuve de prudence et suivez tous les avertissements et pratiques de sécurité lors de l'entretien de cet équipement. De l'énergie et des tensions dangereuses sont présentes dans l'appareil et sur les câbles d'interface qui peuvent choquer ou causer des blessures graves.
- Prenez les précautions suivantes en plus de la formation professionnelle appropriée et des procédures de sécurité :
 - N'utilisez que des outils correctement isolés.
 - Enlevez tous les objets métalliques (porte-clés, lunettes, bagues, montres ou autres bijoux).
 - Suivez les procédures LOTO (Lock Out Tag Out) : spécifiées par le client, spécifiques au site ou générales, selon le cas. Débranchez toute l'alimentation avant d'entretenir l'équipement. Vérifiez s'il y a plusieurs entrées d'alimentation.
 - Portez des lunettes de sécurité.
 - Respectez les exigences relatives à l'équipement de protection individuelle : spécifiées par le client, spécifiques au site ou générales, selon le cas.
 - Testez les circuits avant de les toucher.
 - Soyez conscient des dangers potentiels avant d'entretenir l'équipement.
 - Identifier les potentiels électriques dangereux exposés sur les connecteurs, le câblage, etc.
 - Éviter de contacter les circuits lors du retrait ou du remplacement des couvercles;
 - Utilisez une sangle ESD personnelle lorsque vous accédez à des composants électroniques ou que vous les retirez.
- Le personnel qui possède des appareils médicaux électroniques doit savoir que la proximité des systèmes d'alimentation et de distribution en courant continu, y compris les batteries et les câbles, que l'on trouve généralement dans les salles de services de télécommunications, peut avoir une incidence sur les appareils électroniques médicaux, tels que les stimulateurs cardiaques. Les effets diminuent avec la distance.

Safety Symbols and Guidelines

Read and follow all safety statements, warnings, and precautions in this manual before installing, maintaining or repairing this equipment.

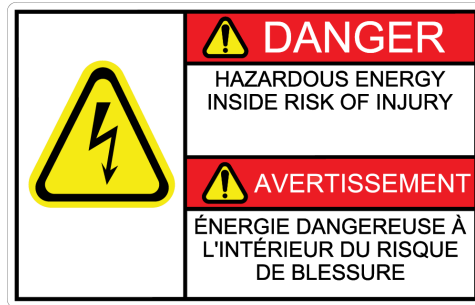

Potential touch current

CP2725 rectifiers	32.8mA
CP3000 or CP3500 rectifiers	65.6mA

RISK OF FIRE

Install only on concrete or other non-combustible surface.

RISQUE D'INCENDIE

Installer seulement sur du béton ou tout autre sol en matériau non combustible.



REFER TO INSTRUCTIONS FOR INSTALLATION AND SAFETY INSTRUCTIONS.
SE RÉFÉRER AUX INSTRUCTIONS POUR L'INSTALLATION ET LES CONSIGNES DE SÉCURITÉ.

HAZARDOUS VOLTAGE

TENSION DANGEREUSE

Customer Care

For any questions on this product or its configuration please contact our 24/7 technical support at +18775463243.



CPL48-19-AC5H-PS8-DC1ES

Equipment Identification

The product ID label on left side of distribution panel is shown below. It includes the product serial number and input - output specifications of the product.

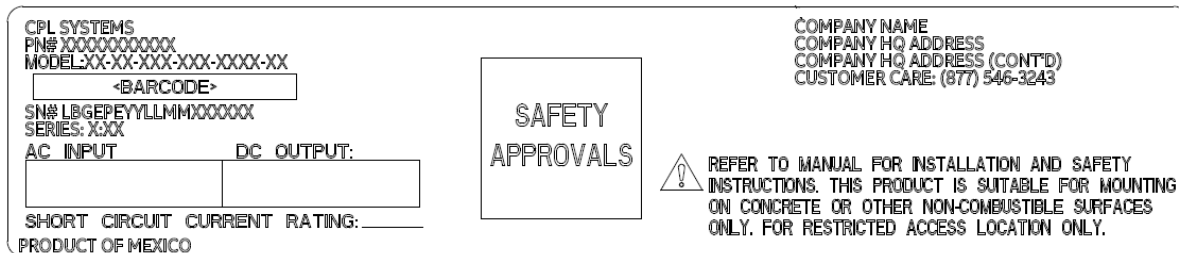

Equipment electrical specification

Refer to the product ID label on left side of distribution panel for equipment ratings

Check for deliveries:

Make sure that the box contains the

1. (1) Fully Assembled Power System
2. Thread-knurling 12-24 Mounting Screws (CC408577571)
3. 5/16 Hardware (Nuts, Flat Washers, Lock Washers) for battery connections
4. 1/4-20 nuts for load connections

CPL -19-AC -PS -DC E -

48: FOR -48V
48P: FOR +48V

19" RACK WIDTH

PS4: 4 POWER SUPPLY SLOTS
PS8: 8 POWER SUPPLY SLOTS
ETC.

AC3L: IEC C19 (CP2725)
AC3: IEC C19 (CP3000)
AC5: TERMINAL BLOCK (CP2725)
AC5H: TERMINAL BLOC (CP3000/CP3500)

1: 20 POSITIONS
2: 40 POSITIONS

INITIAL DISTRIBUTION
BLANK: LOAD/BATTERY SELECTABLE BREAKER POSITIONS
S: ALL BREAKER POSITIONS ARE LOAD (BULK BATT INPUT)

LVBD: LOW VOLTAGE BATTERY DISCONNECT
LVLD: LOW VOLTAGE LOAD DISCONNECT
BLANK: NONE

Refer to CPL-SYSTEM-AD for ordering information.

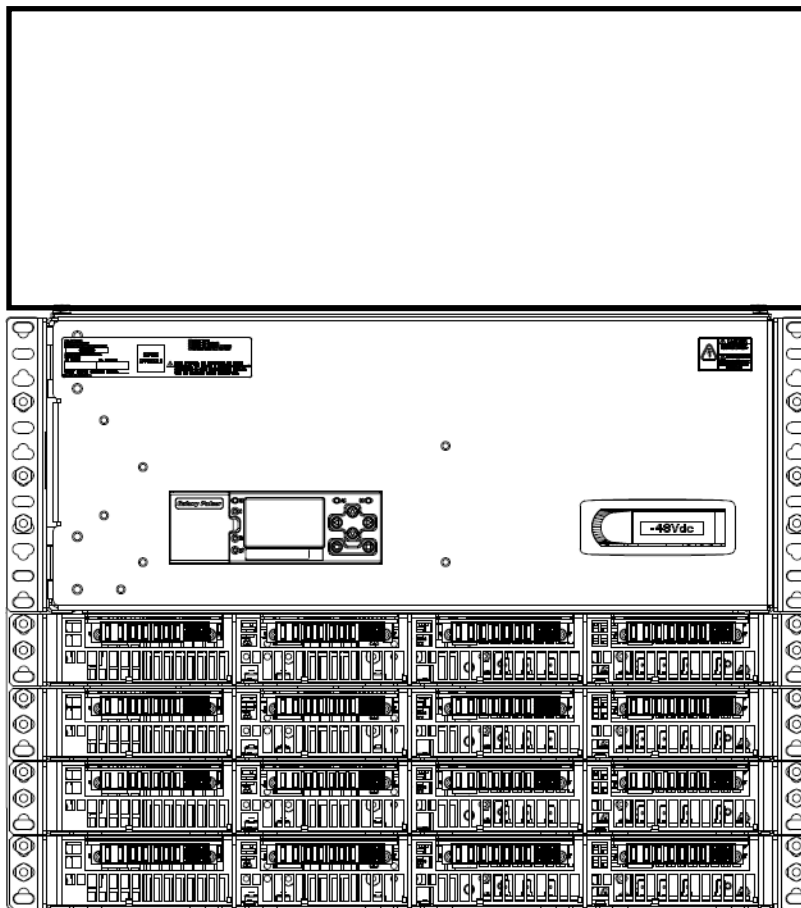

Optional Supplemental Distribution
(not shown)

Initial Distribution

Initial Rectifier Shelf

Optional Supplemental Rectifier Shelves
(maximum of 4)



Information: Tools Required

- Cable Crimpers
- Torque wrench (0-240 in-lb / 28 Nm)
- 5/16," 7/16" and 1/2" nut drivers
- Screw Drivers
- Screw Drivers (#1 Flat & #2 Phillips)
- Wire cutters and strippers

Note: The images shown in this document are for presentation purpose, connections of system will vary based on different configurations.

Read and follow all safety statements and precautions in this guide.

Step 1 – Mount the System

Mount the system with a minimum gap of 3 inches behind the system to allow proper airflow.

1. Attach the system to the frame using a minimum of twelve (six on each side) 12-24 screws (provided).
Torque to 35 in-lb (7.3 Nm) - 5/16" socket.

Step 2 – Connect Chassis and DC Reference (CO) Ground

1. Chassis Ground lug - #10 or 1/4" on 5/8" centers (not provided).
Minimum 10 AWG recommended.
Torque to 10-32 screws to 30 in-lb (3.4 Nm) – 5/16" Socket.
2. DC reference ground lug - 5/16" or 3/8" on 1" centers (not provided).
Torque to 160 in-lb.

Note: If connecting chassis ground to frame surface remove non-conductive frame coating and apply antioxidant for connection.

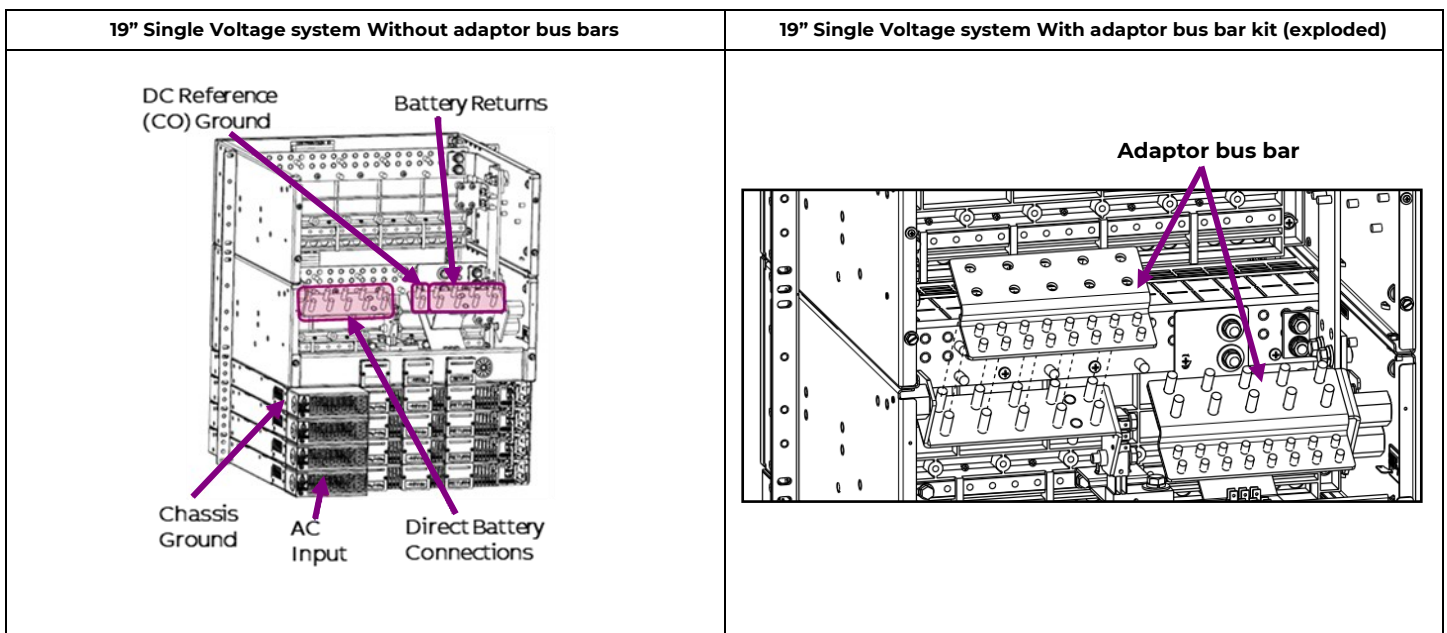

Step 3 – AC input connection

Caution: When routing AC, ensure cables do not come in contact with sharp or rough surfaces that may damage insulation and cause a short circuit.

AC3/ AC3L

Note: For ease of installation, AC connections should be made starting with left most cable of the lower most rectifier shelf.

1. Using customer provided IEC C19/C21 terminated cables, make connection to each rectifier IEC input in the rear of each rectifier shelf.
2. Verify cables are seated properly and secured to the shelf AC input cable support bracket using either tie straps or lacing thread.
3. Continue process until all rectifier positions are made and secured.

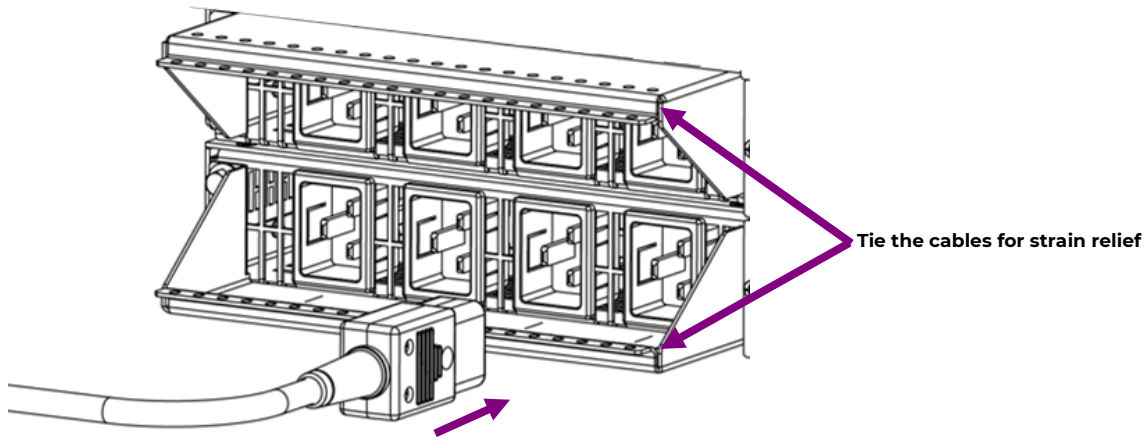

WARNING!: The AC power inlet for this equipment may reach temperatures up to 90°C in normal operation.

To reduce risk of fire, this equipment must be used only with an AC supply cord with the following ratings.

- UL Listed Cord Set (not just cord jacket) rated for a minimum temperature of 90°C
- Minimum cord length 2.4 m (8 ft.)
- Minimum 12 AWG conductor size
- Plug types 5-20P, 6-20P, or L6-20P only

Information: AC Cable

Cable size :	12AWG
Length :	2.4m (8ft)
Minimum Current rating :	20A
Maximum Voltage rating :	250V
Minimum AC Cable Temperature Rating :	90°C

Step 3 – AC input connection (continued)

CAUTION: When routing AC, ensure cables do not come in contact with sharp or rough surfaces that may damage insulation and cause a short circuit.

AC terminal block is in the AC box on the rear of the rectifier shelf.

Rectifiers numbers are labeled at each AC input.

AC terminal connections are labeled at each position (L1, L2/N).

AC5/AC5H (wired to each power slot individually)

Connect 100-120/208-277 VAC at rear of each rectifier shelf.

Connect AC input conductors to the detachable input terminal block (provided) in the wiring box – knock out for 3/4" conduit or cord grip. Strip and torque per table.

Pull on wire to verify secure connection.

Information: AC5/AC5H Terminal block	
Rectifiers per feed:	1
AWG max:	10
Strip Wire (mm):	10
Torque In-lb. (Nm):	7 (0.75)

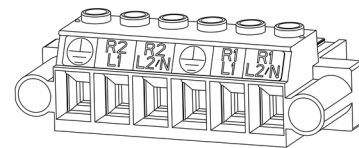

AC5H Terminal block

AC5H+Terminal block adaptor kit (wired to two power slots per input feed)

Connect 100-120/200-277 VAC at rear of each rectifier shelf.

Attach terminal block adapter over AC5 or AC5H input terminal block.

Connect AC input conductors to the detachable input terminal block adapters in the wiring box – knock out for 3/4" conduit or cord grip. Strip and torque per table.

Pull on wire to verify secure connection.

Information: Terminal block adaptor (I600467317A)	
Rectifiers per feed:	2
AWG max:	8
Strip Wire (mm):	10
Torque In-lb. (Nm):	12 (1.4)

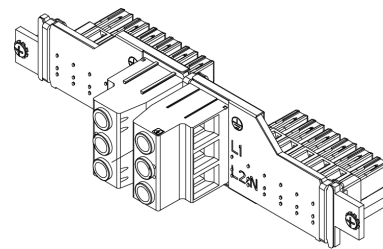

Terminal adaptor kit

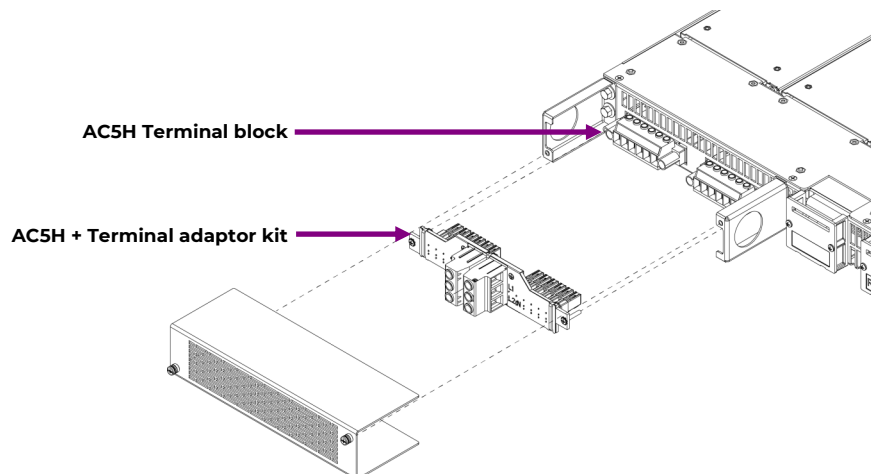

Step 4 – Connect Batteries and DC Output to Loads

The figure to the right shows the DC circuit of the system.

Battery connections may be made to bullet-style distribution positions configured as Battery Breaker Positions or direct to the battery bus.

Caution: Verify battery voltage and polarity with a voltmeter before connecting.

Load connections are made to bullet-style distribution positions configured as Load Breaker Positions.

Distribution panels are each equipped with 20 (19" panel) bullet-style distribution positions. For some distribution panels, each position is selectable between battery and load outputs (see view below). Breaker sizes up to 250A, TPS fuses to 70A and GMT fuses to 12A are available.

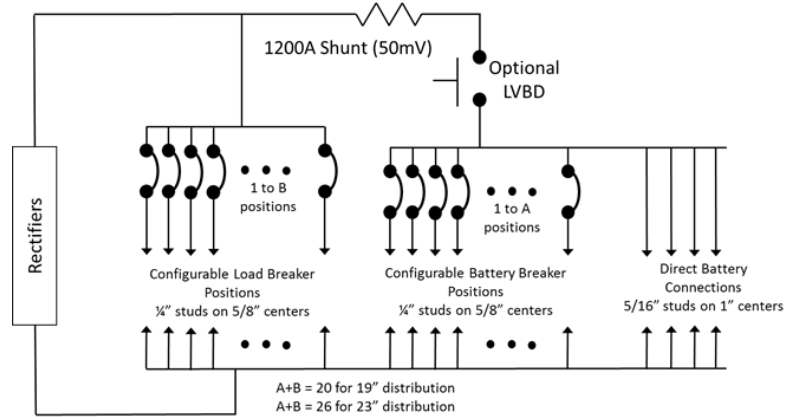

	Lug Landings	
	Distribution	Battery Bus
Landings	1/4-20 studs on 5/8" centers Lug tongue width 0.68" max	5/16-18 studs on 1" centers
Torque	65 in-lb - 7/16" socket	160 in-lb - 1/2" socket

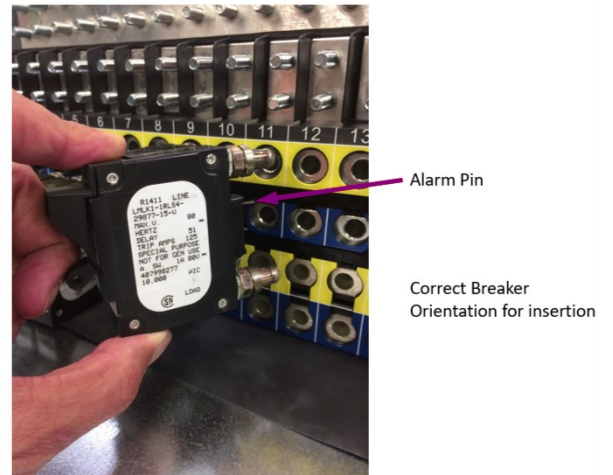
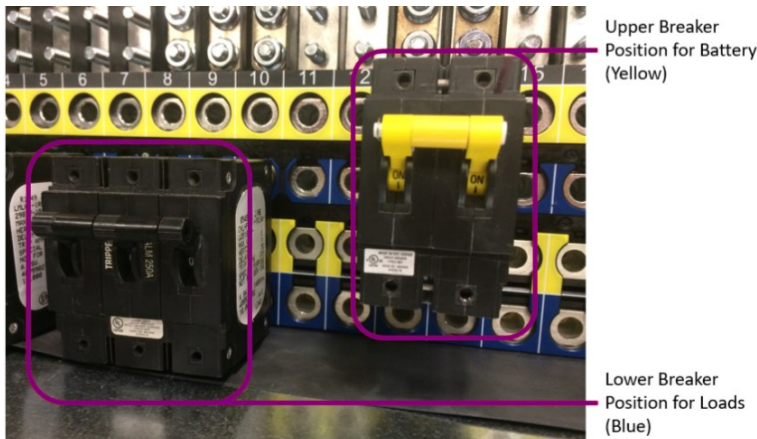

Yellow	+24 VDC Bus
Blue	-48 VDC Bus

Two multi-pole adapters are required for each multi-pole breaker - see illustration

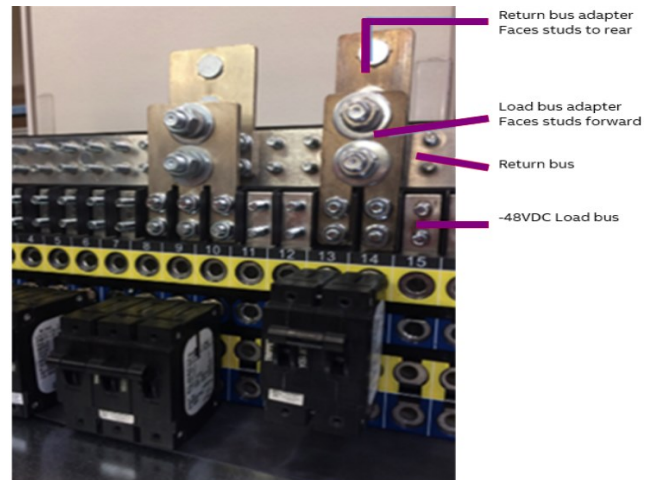

Multi-Pole Adapter Kits - 2 required per breaker			
	CC848756916	850021775	850021955
Poles	2	2	3
Lug Landings	1/4" x 5/8"	3/8" x 1"	3/8" x 1"

Step 5 – Set Controller alarm relay jumpers

Pulsar Plus

Set jumpers 1 thru 10 for the ten alarm relays as Close on Alarm or Open on Alarm; Factory default setting is Open on Alarm.

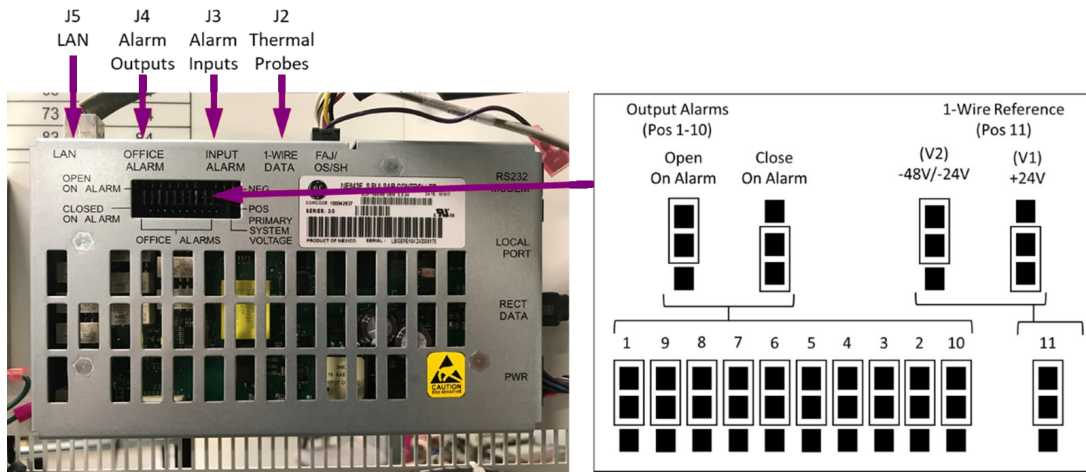

Step 6 – Set Controller Jumpers

Connect per site engineering instructions.

Pulsar Plus - Connect to J2, J3, J4, and J5.

See Information Controller Connections & Information Battery Connections.

Step 7 – Rectifier Installation

Caution: The rectifier latch is not a carrying handle.

1. Slide the rectifier into the rectifier slot approximately $\frac{3}{4}$ of the way.
2. Open the faceplate by sliding the latch to the left until the faceplate releases and swings outward.
3. Slide the rectifier into the slot until it engages with the back of the shelf. Swing the faceplate closed to fully seat the rectifier. Verify the faceplate is latched.
4. Correct insertion of the rectifier will automatically add the unit to the controllers' inventory of units.

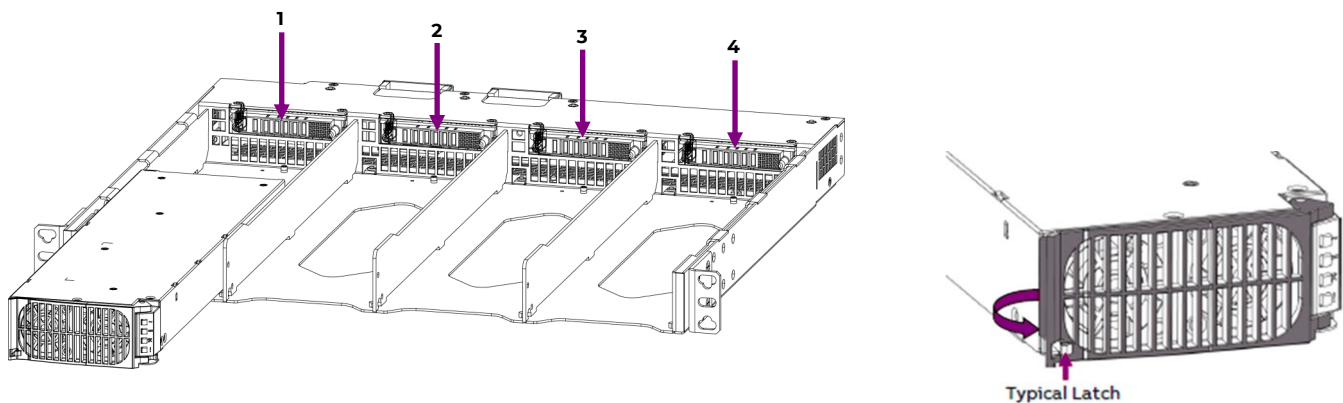

To remove a rectifier:

- A. Open latch fully to release and remove.
- B. Enter Inventory section of controller and remove hardware to clear alarm.

Step 8 – Initial Startup

Verify that all AC, DC, GND and Controller connections are complete and secure.

Using a multimeter, Verify plant reference ground and chassis ground resistance to side ground bar is less than 0.1 Ohms. With rectifiers and converters unplugged as well as all load breakers on and AC breakers off, verify resistance of battery bus to ground is greater than 1MΩ. If being operated as an ungrounded system, verify both positive and negative bus measurement to each other and ground is greater than 1MΩ.

Turn on AC input breakers. If there are no alarms, make required adjustments to the default settings on the controller for this installation.

Step 9 – Configure Controller

Verify and edit controller basic configuration parameters per site engineering instructions.

Refer to Galaxy Pulsar Plus Product Manual for additional information.

Information: Controller Default Voltage Settings

Parameter	Range	Valve-Reg (Default)	Flooded	NiCd
Rectifier Float Selective High Voltage Shutdown	-50 to -60V	58.50	58.50	58.50
High Float Voltage Major Alarm	-50 to -60V	57.00	57.00	57.00
High Float Voltage Minor Alarm	-50 to -60V	56.00	56.00	56.00
Rectifier/System Float Voltage	-42 to -56.5V	54.48	52.08	54.40
Battery on Discharge Float Alarm	-46 to -55V	51.00	50.00	51.00
Very Low Float Voltage Alarm	-40 to -51V	46.00	46.00	46.00
Rectifier On Threshold	-40 to -51V	44.00	44.00	44.00

Information: Battery Monitoring Connections

Battery Monitoring is accomplished with a “Daisy Chained” series of probes connected to J2. The Probes monitor battery temperature and voltage (ES771 required to monitor voltage). Bolt the Probe under the “-” terminal connector hardware; NOT under the connecting lug.

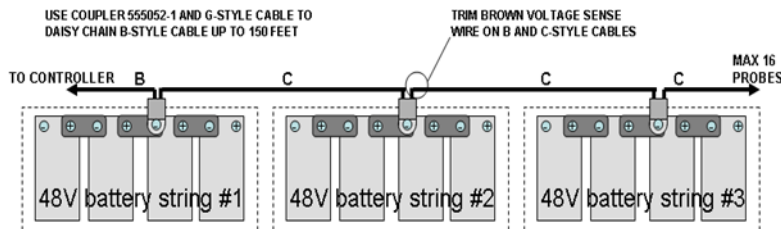

Temperature Measurement

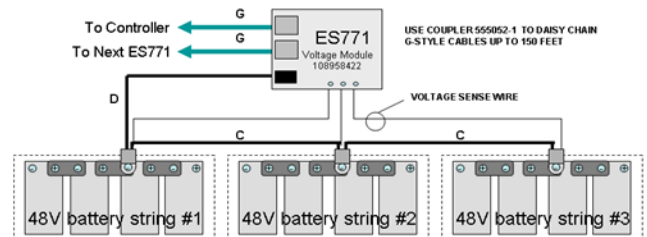

Temperature and Voltage Measurement

Information: Battery Monitoring Connections - cables

Order Codes	Descriptions	Order Codes	Descriptions
CC109142980	QS873A Thermal Probe	108958422	ES771A Voltage Monitor Card
CC848817024	B 10' controller to thermal probe wireset	CC848791517	D 2 ½' ES771A to probe wireset
CC109157434	B 20' controller to thermal probe wireset	CC848797290	D 6' ES771A to probe wireset
CC848822560	C 1' thermal probe to thermal probe wireset	848719829	D 10' ES771A to probe wireset
848719803	C 5' thermal probe to thermal probe wireset	CC848791500	G 4' ES771A to ES771A or controller wireset
CC848822321	C 10' thermal probe to thermal probe wireset	848652947	G 10' ES771A to ES771A or controller wireset

Temperature Measurement

Temperature and Voltage Measurement

Information: Controller Connections

Alarm Outputs

Alarm relays are factory set to Open On Alarm. If Close On Alarm is desired adjust controller alarm jumpers. See diagram in step 5 for the location of the controller alarm jumpers. Connector J4 provides access to the primary customer alarm outputs. J4 is a 20-pin latching connector.



Alarm Output Cables

CC848890137	5 ft
CC109157442	15ft
CC848817635	50 ft
CC848817643	150 ft

Alarm Inputs

Default alarm descriptions may be changed as needed using web pages or Easyview2.

J3 is a 10-pin latching connector.



Alarm Input Cables

CC848890153	5 ft
CC848865980	15ft
CC848817651	50 ft
CC848817668	150 ft

Standard Controller Alarm Output Defaults	Pin	Color Option 1	Color Option 2	
PCR	Power Critical	1	BL	BL
PCR_C	Power Critical_C	11	W	BL/BK
PMJ	Power Major	2	O	O
PMJ_C	Power Major_C	12	W	O/BK
PMN	Power Minor	3	G	G
PMN_C	Power Minor_C	13	W	G/BK
R1	Battery On Discharge	4	BR	W
R1_C	Battery On Discharge_C (BD_C)	14	W	W/BK
R2	Very Low Voltage (VLV)	5	S	BK
R2_C	Very Low Voltage_C (VLV_C)	15	W	BK/W
R3	Fuse Alarm Major (FAJ)	6	BL	BL/W
R3_C	Fuse Alarm Major_C (FAJ_C)	16	R	BL/R
R4	AC Fail (ACF)	7	O	O/R
R4_C	AC Fail_C (ACF_C)	17	R	R
R5	Rectifier Fail (RFA)	8	G	G/W
R5_C	Rectifier Fail_C (RFA_C)	18	R	R/G
R6	Mult. Rectifier Fail (MRFA)	9	BR	W/R
R6_C	Mult. Rectifier Fail_C (MRFA_C)	19	R	R/W
R7	High Voltage (HV)	10	S	BK/R
R7_C	High Voltage_C (HV_C)	20	R	R/BK

Standard Controller Alarm Input Defaults	J3 Pin	Color
Air Con Fail	1	BK
Air Con Fail_Return	8	V
Door Open	2	BR
Door Open_Return	8	V
Aux PMJ Input	3	R
Battery Test/GSTR	4	O
Battery Test_Return	9	S
EPO	5	Y
EPO_Return	10	W
Hi ext. Temp.	6	G
Hi ext. Temp_Return	8	V
Low ext. Temp.	7	BL
Low ext. Temp_Return	8	V

Information: Controller Basic Operation

View and change system parameters from the factory defaults via

- A) Controller Display
- B) Craft Port on front of controller using a laptop with EasyView2 software or HyperTerminal.
EasyView2 (GUI) software can be downloaded from omnionpower.com
- C) J5 LAN port web pages using a laptop with browser. LAN port Server mode is for local laptop connection. Set the LAN port to Server:

Controller Alarm Status: The display changes colors; Green = Normal, Amber = Minor Alarm, Red = Critical/Major Alarm

Some alarms may occur during initial installation; eg: thermal probe fail or Major/Minor communication fail.

Clear these alarms: Via Controller Display: follow the menu path;

Menu > Control/Operation > Clear Events or Uninstall Equipment.

Verify Basic Installation Settings: Date, Time, Battery Type, number of strings and float voltage

Menu > Configuration > System Settings and Menu > Configuration > Batteries.

Front Panel

View and change system parameters from the factory defaults via the front panel:

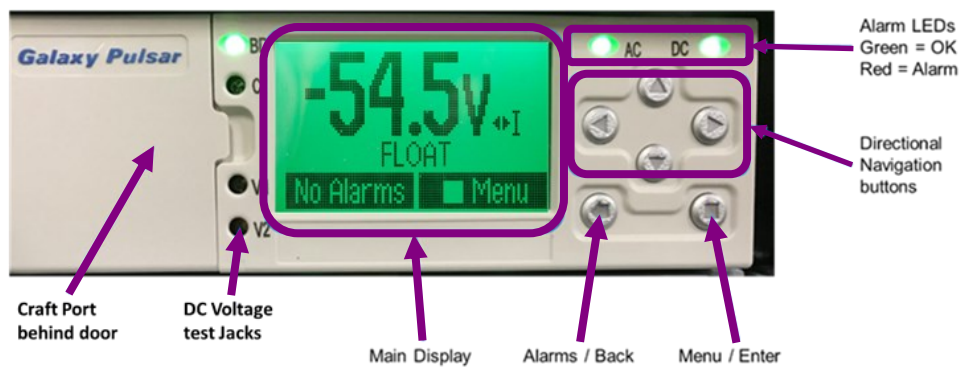

Controller Front Panel Display and Controls

The main menu can be accessed using the Menu / Enter button.

The basic menu structure for navigation is shown below.

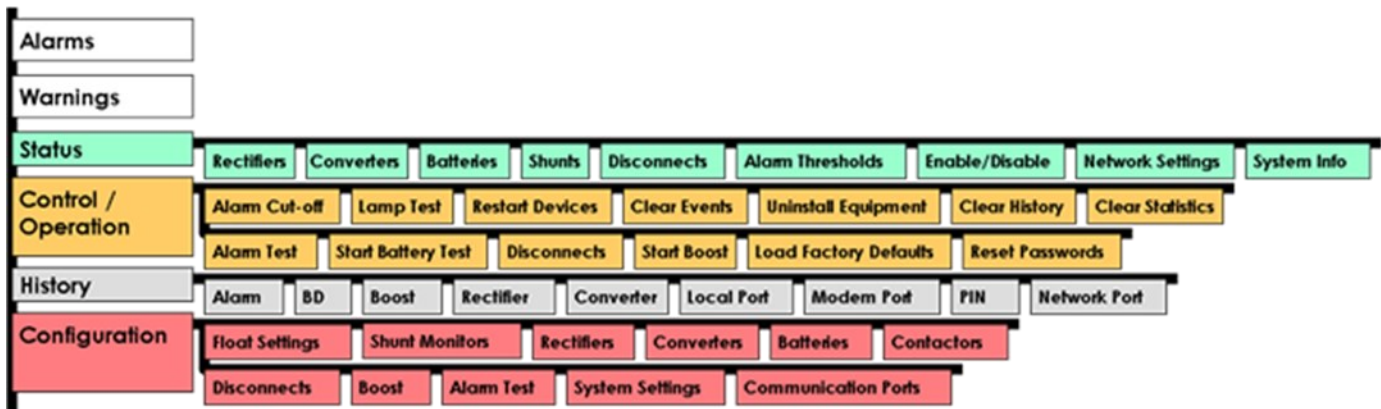

Front Panel Menu Structure - Overview

Information - Controller Basic Operation (continued)

All user configurable parameters can be accessed from the front panel, however user convenience and visibility is enhanced by access through the LAN port using the built-in web pages.

Configuration > Communication Ports > Network Settings > DHCP > mode, to SERVER.

Once the LAN port is configured as a server, the laptop can be connected to the LAN port, using a standard ethernet cable. Use a standard web browser to access the controller web pages at default IP address: 192.168.2.1.

Warning: Do not connect LAN port to a network when set to Server mode. Set the controller LAN port to Client or Static before connecting to the network. Static is the factory default setting and the typical setting for most networks.

Once connected to the controller web server a log on screen should be visible:



Logon Screen - web view

Factory Default password is “Administrator” and should be used for initial logon. It is highly recommended that one of the first activities should be to change the default password(s).

The Home Page - Web View is divided into several sections:

- Plant Status:** Displays site information (APN 0651-171-07-0000, Hvasu Pass, California), bus voltages (53.86 V), and currents (26.9 A).
- Battery:** Shows installed capacity (4560 Ah), state of charge (94.8%), and temperature readings.
- Plant Configuration:** Details rectifier and solar drain capacities.
- Alarm Status:** A table listing any active alarms or warnings.
- Contactor Status:** A table showing the status of different contactor interfaces.

Severity	Event	Date	Time
-	no alarms	-	-
-	no warnings	-	-

Description	Type	Current
Plant Current	BATTERY	-100.6 A

Description	Type	State
Contactor Interface 1	LVB0	NONE
Contactor Interface 2	LVD1	NONE

Home Page - Web View

Information: Rectifier Status LEDs

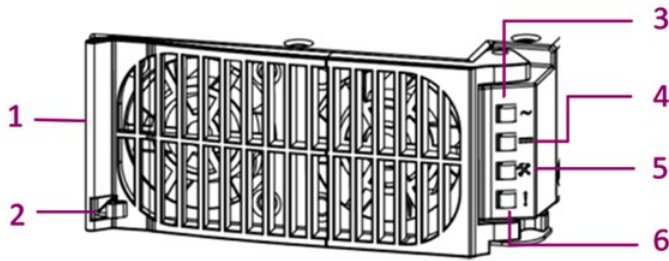

1	Handle
2	Locking latch
3	AC OK indicator
4	DC OK indicator
5	Service LED
6	Fault indicator

Application Notes

External Surge Protective Device (SPD) is required on all AC inputs.

Equipment and subassembly ports:

1. are suitable for connection to intra-building or unexposed wiring or cabling;
2. can be connected to shielded intra-building cabling grounded at both ends.

Grounding / Bonding Network – Connect to an Isolated Ground Plane (Isolated Bonding Network) or an Integrated Ground Plane (Mesh-Bonding Network or Common Bonding Network).

Installation Environment - Install in Network Telecommunication Facilities, OSP, or where NEC applies.

Battery return may be either Isolated DC return (DC-I) or Common DC return (DC-C).



Ordering Information

Please contact your OmniOn Power™ Sales Representative for pricing, availability and optional features.

Power Supplies		
Ordering code	Description	Picture
1600422507A	CP3000AC54TEZB Rectifier (Input: 100-120V _{AC} 20.8-14.2A, Output:44-58V _{DC} @1500W) (Input: 200-277V _{AC} 17.5A, Output:44-58V _{DC} @3000W)	
1600418753A	CP3500AC54TEZB Rectifier (Input: 100-120V _{AC} 20.8-14.2A, Output:44-58V _{DC} @1500W) (Input: 200-277V _{AC} 20.5A, Output:44-58V _{DC} @3500W)	
CC109149423	CP2725AC54TEZ Rectifier (Input: 100-120V _{AC} 15-10.8A, Output:44-58V _{DC} @1200W) (Input: 200-277V _{AC} 14A, Output:44-58V _{DC} @2725W)	
150033916	CP3000AC54TEZ Rectifier (Input: 100-120V _{AC} 20.8-14.2A, Output:44-58V _{DC} @1500W) (Input: 200-277V _{AC} 17.5A, Output:44-58V _{DC} @3000W)	
150030396	CP3500AC54TEZ Rectifier (Input: 100-120V _{AC} 20.8-14.2A, Output:44-58V _{DC} @1500W) (Input: 200-277V _{AC} 20.5A, Output:44-58V _{DC} @3500W)	

Ordering Information (continued)

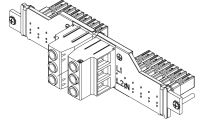
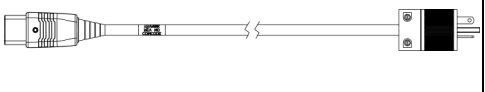
Please contact your OmniOn Power™ Sales Representative for pricing, availability and optional features.

AC Input Accessories			
AC Input Type	Ordering code	Description	Picture
AC5H+	1600467317A	AC5H+ Terminal block adaptor kit	
AC3/AC3L	8600481880P	SJT Cord, 12AWG, 8ft (Min.), 3 conductors, 105°C Termination: Shelf End IEC C19 /C21 Other End: NEMA 5-20P, 20A, 125V	
	8600481881P	SJT Cord, 12AWG, 8ft (Min.), 3 conductors, 105°C Termination: Shelf End IEC C19 /C21 Other End: NEMA 6-20P, 20A, 250V	
	8600481882P	SJT Cord, 12AWG, 8ft (Min.), 3 conductors, 105°C Termination: Shelf End IEC C19 /C21 Other End: NEMA L6-20P, 20A, 250V	

Bullet Style Load Circuit Breakers				
Ordering Code	Amperage	CB Positions (Poles)	Min Wire Gauge	Photo
407998137	3	1	10	
407998145	5	1	10	
407998152	10	1	10	
407998160	15	1	10	
407998178	16	1	10	
407998186	20	1	10	
407998194	25	1	10	
407998202	30	1	10	
408213486	40	1	10	
407998210	45	1	8	
407998228	50	1	8	
407998236	60	1	6	
407998244	70	1	6	
407998251	80	1	4	
407998269	90	1	4	
407998277	100	1	2	

Bullet Style Battery Circuit Breakers		
Ordering Code	Amperage	Photo
CC408574395	100	
CC408574404	125 (2-pole)	
CC408574412	150 (2-pole)	
CC408574420	200 (2-pole)	
CC408645295	250A (3-pole)	

Change History (excludes grammar & clarifications)

Revision	Date	Description of the change
1.0	20-12-2023	Initial release
1.1	02-28-2024	Updated as per OmniOn template
1.2	04-05-2024	Added short circuit current rating, Derating information, added bullet breaker ordering information, Updated images in step-4, Updated product image
1.3	12-24-2024	Updated terminal block adapter kit image

OmniOn Power Inc.

601 Shiloh Rd.
Plano, TX USA

omnionpower.com

We reserve the right to make technical changes or modify the contents of this document without prior notice. OmniOn Power™ does not accept any responsibility for errors or lack of information in this document and makes no warranty with respect to and assumes no liability as a result of any use of information in this document.

We reserve all rights in this document and in the subject matter and illustrations contained therein. Any reproduction, disclosure to third parties or utilization of its contents – in whole or in parts – is forbidden without prior written consent of OmniOn Power™. This document does not convey license to any patent or any intellectual property right. Copyright© 2024 OmniOn Power Inc. All rights reserved.